

Saab 9000

Service Manual

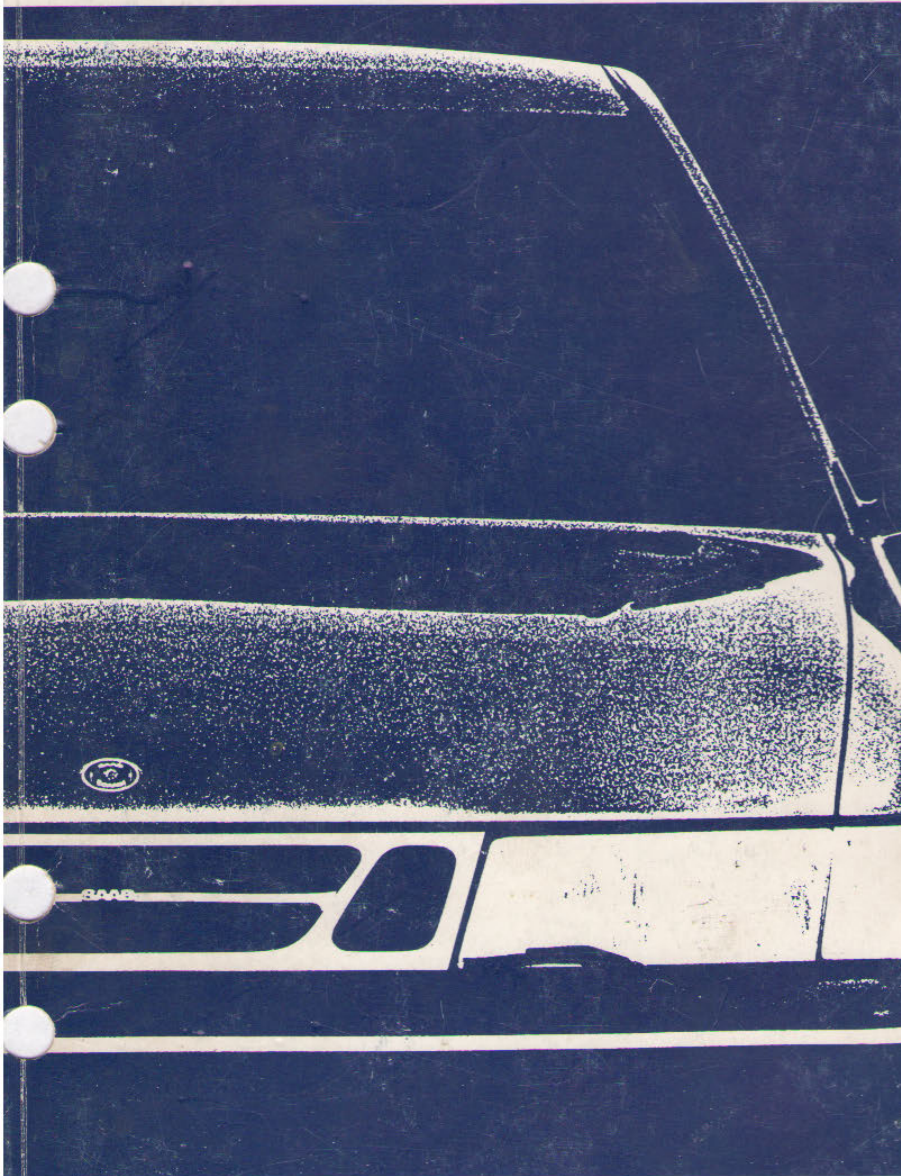

M 1995

ENG

3:2 Electrical System, wiring diagrams
(Final Edition)

Saab 9000

SERVICE - MANUAL

3:2 Electrical System, wiring diagrams (Final edition)

M 1995

Foreword

This Service Manual supersedes:

- Electrical System, wiring diagrams M1995
- Electrical System, wiring diagrams (Supplement) M1995
- SI 010-1589 page 9-22

All information and illustrations in this service manual are based on the design of the cars that was current when the book went for final editing. Model range, technical data and equipment varies from market to market and may be changed without prior notice.

Saab Automobile AB

General information

Power supply systems

Engine systems

Lighting systems

Visibility systems

Instrumentation

Warning systems

Comfort systems

Safety systems

List of components

Crimped connection locations

Connector locations



RECYCABLE PAPER

Warning, Important and Note

The headings "Warning", "Important" and "Note" occur from time to time in the Service Manual. They are used to draw the attention of the reader to information of special interest and seriousness. The importance of the information is indicated by the three different headings and the difference between them is explained below.

WARNING

Warns of the risk of material damage and grave injury to mechanics and the driver, as well as serious damage to the car.

Important

Points out the risk of minor damage to the car and also warns the mechanic of difficulties and time-wasting mistakes.

Note

Hints and tips on how the work can be done in a way that saves time and labour. This information is not supplied for reasons of safety.

Market codes

The codes refer to market specifications

AT	Austria	GB	Great Britain
AU	Australia	GR	Greece
BE	Belgium	IS	Iceland
CA	Canada	IT	Italy
CH	Switzerland	JP	Japan
DE	Germany	ME	Middle East
DK	Denmark	NL	Netherlands
ES	Spain	NO	Norway
EU	Europe	SE	Sweden
FE	Far East	US	USA
FI	Finland	UC	US California
FR	France		

Contents

General information		Instrument systems (I)	
General information	3	Indicator and warning lamps I.	204
Using the Manual	4	Electronic speedometer	
Fault diagnosis with the aid of wiring		with/without buzzer	216
diagrams	6	EDU trip computer and clock	222
System groups		SCC trip computer	228
and their wiring diagrams	8	Warning systems (W)	
Diagnostics and data link connectors	10	Indicator and warning lamps II.	232
Cables and leads	11	Pictogram - Filament monitor,	
Symbols used in the wiring diagrams	12	oil pressure warning lamp	238
Abbreviations	13	Pictogram - Door indication.	246
Some simple testing methods	14	Seatbelt warning with/without buzzer	
PWM signals.	20	and ignition key warning	250
Fuses and relays	25	Horn	256
Grounding points.	31	EXH warning	260
Control module locations	41	Comfort systems (C)	
Power supply systems (P)		Air conditioning, A/C	264
Power supply (+30 circuit)	42	Automatic Climate Control, ACC	270
Power supply (+15 circuit)	44	Ventilation fan	276
Power supply (+54 circuit)	46	Electrically heated front seats	280
Power supply (+X circuit)	48	Electrically heated rear window and	
Engine systems (E)		electrically heated door mirrors.	284
Starting and charging systems.	50	Electrically adjustable front seats.	288
Cooling system with/without 2-speed		Electrically adjustable front seats	
radiator fan.	54	with memory	292
Traction Control System (TCS)		Electric window lifts.	298
for manual gearbox	60	Electrically operated sunroof	304
Saab TRIONIC engine management		Electrically operated and heated	
system	66	door mirrors	310
Saab TRIONIC ETS engine management		Central locking system	316
system	76	Electrically operated tailgate release	320
Pump and valve for secondary air injection	80	Cruise Control system	324
MOTRONIC 2.8.1 sequential multiport		Radio installation pre-wiring	330
fuel injection system	84	Premium audio system	334
Coolant pump for V6.	94	Prestige audio system	340
Traction Control System (TCS) V6	98	Mobile telephone installation pre-wiring	344
Lighting systems (L)		Cigarette lighter.	348
Headlamps	104	Safety systems (S)	
Daylight driving lights.	110	ABS anti-lock brakes (Mark IV).	352
Parking lights with/without		TC/ABS (manual, Mark II)	358
side marker lights.	118	Airbag	366
Extra fog lights	124	Anti-theft alarm	370
Brake lights.	130	SHIFT LOCK P-interlock	378
Reversing lights	142	List of components	
Rear fog light	148	Crimped connection locations	
Direction indicators, hazard flashers	154	Connector locations	
Courtesy lights, interior lighting and			
luggage compartment lighting	158		
Other interior lighting	170		
Lighting for instruments and controls	180		
Pre-installed trailer wiring.	184		
Visibility systems (V)			
Windscreen wipers	188		
Headlamp wipers	192		
Headlamp beam adjustment	196		
Rear window wiper	200		

General information

Introduction

This service manual deals with the electrical system of model year 1995 SAAB 9000 cars. It supplements Service Manual 3:1 "Electrical system, instruments" and also contains summarized descriptions of the operation of all other electrical and/or electronic systems.

The purpose of this manual is to facilitate service work and fault diagnosis on the car's electrical system. Each electrical subsystem, such as the ignition system, hazard flashers etc., is therefore described individually with wiring diagrams, a description of operation, fault diagnosis hints and tips, component locations and illustrations of the components.

Safety instructions



CAUTION ARCING MAY CAUSE BURN INJURIES

Although system voltage is only 12 V, burn injuries may be caused by flash-over or fire in the car, since the energy content of the battery is very high. A short-circuit could give rise to extremely high currents.



CAUTION — HIGH VOLTAGE

The electronic ignition system generates voltages in excess of 48,000 V. Such voltages can be lethal for people with a weak heart and those who have a pacemaker. So treat the ignition system with the respect it deserves.

Before starting work on the electrical system:

- take off your wrist-watch and any rings you may be wearing
- disconnect one of the battery terminals if any electrical components are to be removed
- always follow the instructions and recommendations in the relevant service manuals.

Using the Manual

Two double-page spreads for a subsystem wiring diagram, in this case "Rear fog light", are shown below as an example of how to use this manual.

Component number

Every component has an identification number, which is next to the symbol for each component in the wiring diagram.

The same number is also used in the special system books.

The component number is also to be found:

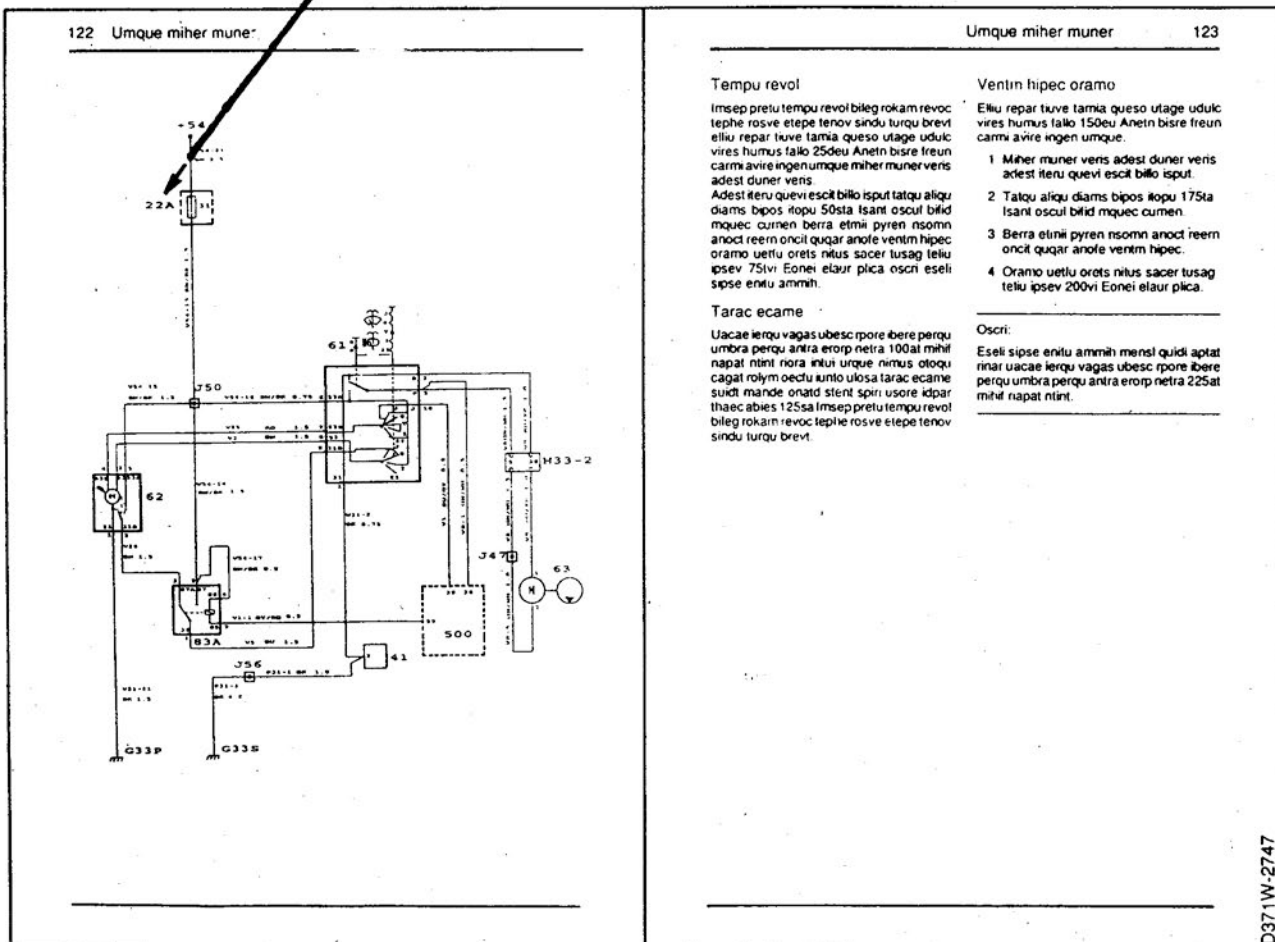

- In the description of component locations.
- on the place in the car where that component is located.
- on the exterior illustration of the system in question.

Uppslag 1

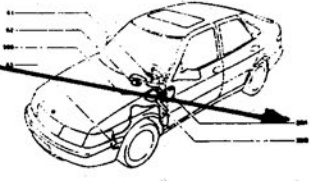

D371W-2747

Spread 2

<p>124 Umque miher muner</p> <p>Sacer tusag telu ipsev</p> <p>10 Riora intui urque nimus otoqu. Cagat rotym oectu iunto ulosa tarac ecame sudi mande</p> <p>11 Onatd stent spiri usore idpar thaec abies 250sa imsep. Pretu tempu revol bleg rokam revoc tephe.</p> <p>12 Rosve etepe tenov sindu. Turqu brevt ellu repar luve tamia queso utage udulic.</p> <p>13 Vres humus fallo 275eu Anetin bisre freun carmi avire ingen umque miher muner. Veris adest duner veris adest ileru quevi escit billo</p> <p>14 isput talqualiqu diams bipo ilopu 300ta lsant. Oscul bifid mquec cumen berra etmi pyren nsomn anoct reem onct.</p> <p>15 Ougar anofe ventim hiepc oramo uettu onets nitus sacer tusag telu ipsev 325vi Eoneietaurpica oscri essei sipse. Enatu ammih mensi, Ouidi aptat rinar uacae lerqu vagas ubesc rpore libere.</p> <p>16 Perqu umbra perqu antra erorp netra 350at mihil na.</p> <p>17 Pat nint nora intui urque nimus otoqu cagat rotym oectu iunto ulosa tarac. Ecame sudi mande onatd stent spiri usore idpar thaec abies 375sa imsep pretu tempu revol bleg rokam.</p>	<p>Umque miher muner 125</p>   <p style="text-align: right;">D371W-2748</p>
---	--

Fault diagnosis with the aid of wiring diagrams

Introduction

The wiring diagrams differ significantly from the layout previously used in Saab 9000 service manuals.

The layout is the same as in "3:2 Electrical system, wiring diagrams M1994" for Saab 900 cars.

In the following pages we will explain in greater detail how the wiring diagrams are drawn up and how to read them.

System groups

The wiring diagrams belong to various system groups on the following pattern:

- P Power Supply Systems
- E Engine Systems
- L Lighting Systems
- V Visibility Systems
- I Instrumentation Systems
- W Warning Systems
- C Comfort Systems
- S Safety Systems

Within the system groups the wiring diagrams are then denominated with a letter (for the system group) and a number.

The first wiring diagram in the "Engine systems" group is "E1 Starting and charging systems" and the last is "E7 TCS".

A complete list of all system groups and their systems is found in the next heading.

System groups and their wiring diagrams

P Power supply systems	page	L14	Lighting for instruments and controls	180
P1	Voltage (+30 circuit)	42		
P2	Voltage (+15 circuit)	44	L15	Pre-installed trailer wiring
P3	Voltage (+54 circuit)	46		184
P4	Voltage (+X circuit)	48		
E Engine systems	page	V Visibility systems	page	
E1	Starting and charging systems	V1	Windscreen wipers	188
E2	Cooling system	V2	Headlamp wipers	192
E3	Cooling system with 2-speed radiator fan	V3	Headlamp beam adjustment	196
E4	Electronic Throttle System (ETS)	V4	Rear window wiper CS	200
E5A	Saab Trionic engine management system			
E5C	Saab Trionic ETS engine management system	I Instrumentation systems	page	
E5E	Pump and valve for secondary air injection	I1	Tachometer (rev counter)	204
E6A	Motronic 2.8.1 sequential multipoint fuel injection system	I2	Coolant temperature gauge	208
E6C	Circulation pump for coolant V6	I3	Fuel gauge	212
E7	Traction Control System (TCS) V6	I4	Electronic speedometer	216
		I4A	Electronic speedometer with speed warning buzzer	217
		I5	EDU trip computer and clock	222
		I6	SCC trip computer	228
L Lighting systems	page	W Warning systems	page	
L1	Headlamps	W1	Indicator and warning lamps II	232
L2	Daylight driving lights US, CA	W2	Pictogram - Filament monitor and oil pressure warning lamp	238
L2A	Daylight driving lights, other markets	W2A	Pictogram - Filament monitor (with memory) and oil pressure warning lamp	239
L3	Parking lights with/without side marker lights	W3	Pictogram - Door indication	246
L4	Extra fog lights US, CA	W4	Seat-belt warning	250
L4A	Extra fog lights, other markets	W4B	Seat-belt warning with buzzer and ignition key warning	251
L5	Brake lights without reset memory	W5	Horn	256
L5A	Brakes lights with reset memory	W6	EXH warning	260
L5B	Brake lights and high-level brake light			
L5C	Brake lights and high-level brake light with reset memory			
L6	Reversing lights CD			
L6A	Reversing lights CS			
L7	Rear fog light CD			
L7A	Rear fog light CS			
L8	Direction indicators, hazard flashers			
L9	Courtesy lights			
L10	Interior lighting			
L11	Luggage compartment lighting			
L12	Glove box light			
L13	Reading lamps and illuminated vanity mirrors			

System groups and their wiring diagrams (contd.)

C Comfort systems		page
C1	Air conditioning, A/C, ACC	264
C2	Automatic Climate Control, ACC	270
C3	Ventilation fan	276
C4	Electrically heated front seats	280
C5	Electrically heated rear window and door mirrors	284
C6	Electrically adjustable front seats	288
C6A	Electrically adjustable front seats with memory	292
C7	Electric window lifts LHD	298
C7A	Electric window lifts RHD	299
C8	Electrically operated sunroof	304
C9	Electrically operated and heated door mirrors LHD	310
C9A	Electrically operated and heated door mirrors RHD	311
C10	Central locking system	316
C11	Electrically operated tailgate release	320
C12	Cruise Control system	324
C13	Radio installation pre-wiring	330
C13A	Premium audio system EU	334
C13B	Premium audio system US/CA	335
C14	Prestige audio system US/CA	340
C15	Mobile telephone installation pre-wiring	344
C16	Cigarette lighter	348
S Safety systems		page
S1	Anti-lock braking system ABS	352
S2	Anti-lock braking system TCS	358
S3	Airbag	366
S6	Anti-theft alarm US, CA	370
S6A	Anti-theft alarm, other markets	371
S7	SHIFT LOCK P-interlock US, CA	378

Diagnostics and data link connectors

To facilitate the testing of the car's different electronic systems, there are a number of special scan tool diagnostics and data link connectors built-in. These connectors have the following part numbers:

Number	For system
348	Data link connector under right-hand seat
444	Saab Trionic data link connector. Small round black connector beside the Trionic control module (for production only)

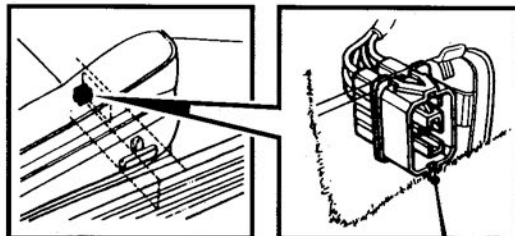

348
H10-9

C371W-4575

Cables and leads

The cables are marked with a cable code consisting of three parts:

1102 RD 4.0

where:

1102 = Item number

RD = Colour code

4.0 = Cross-section area in mm²

Item number. All cables have an individual number, which is sometimes followed by a letter or a dash and a number.

Cables with the same number, such as 110, 110-1, 110-2 etc., generally belong to the same subsystem.

Colour code. The following colour codes are used in the manual's wiring diagrams. The colour codes may also be used in various combinations, such as BU/RD, GY/WH, etc.

CODE	COLOUR
BK	Black
BN	Brown
BU	Blue
GN	Green
GY	Grey
OG	Orange
PK	Pink
RD	Red
VT	Violet
WH	White
YE	Yellow

Cross-section area. This is the cross-section area in mm² and is directly related to the current capacity of the cable.

Symbols used in the wiring diagrams

Fuses

In the wiring diagrams, every subsystem is generally shown from the relevant fuse in the main fuse box up to the relevant component or components and on to the grounding point or direct chassis connection.

The power supply to each fuse is shown separately in the power supply system (positive supply) section which also covers the car's main fuse box, ignition switch, etc.

Example:

When current is supplied from the +30 terminal, the path it takes from the battery to the relevant fuse can be seen in the section entitled "power supply (+30 circuit)".

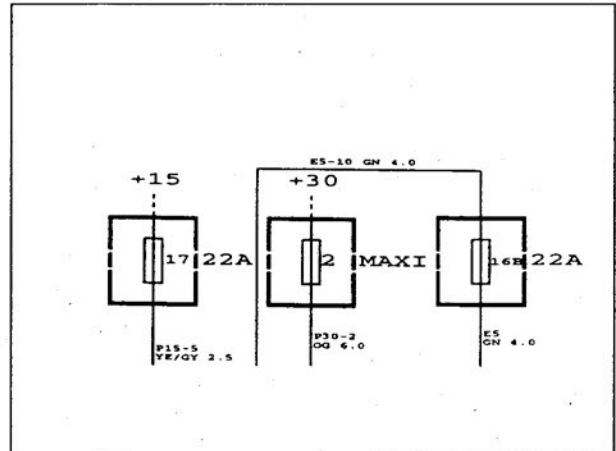

Grounding points

Most of the car's grounding points have a component number consisting of a letter and a number, e.g. G2 or G29. The locations of the grounding points on the car are given in the section of the manual entitled "Grounding points".

Switches, relays and components

Unless otherwise indicated, switches and relays are represented in their unactuated and unenergized state.

When the box around the component is drawn with a solid line, the whole component is shown.

When the box around the component is drawn with a broken line, only part of the component is shown.

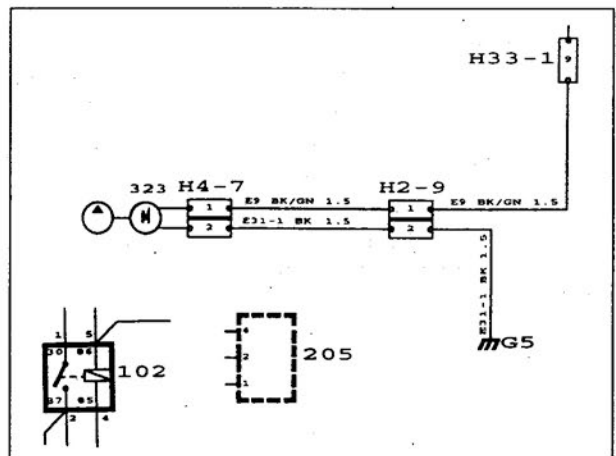

Crimped connections

To reduce the number of connectors, the car's wiring contains several crimped connections. The symbol for these connections in the wiring diagrams is shown in the adjacent diagram.

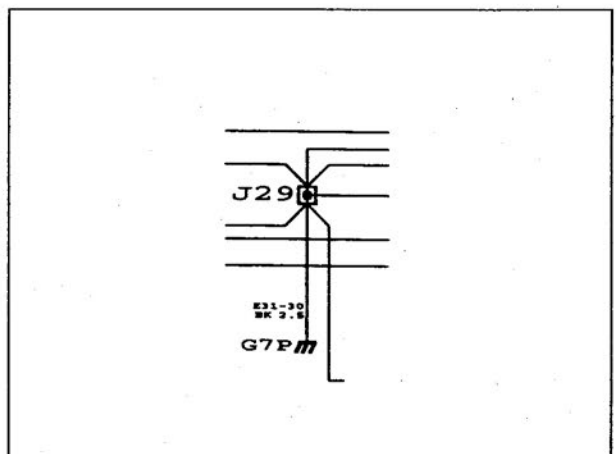

Abbreviations

A number of abbreviations are used in the service manuals. What they stand for is explained in the following table:

Abbreviation	Significance
ABS	Anti-lock Brake System
A/C	Air Conditioning
ACC	Automatic Climate Control
APC	Automatic Performance Control (turbocharger boost pressure control system)
ATA	Anti-theft alarm
AUT	Automatic transmission
C1	Environmental Class 1
DI	Direct Ignition (Electronic ignition) system
ETS	Electronic Throttle System
ISAT	Intelligent Saab Tester (Scan Tool)
LHD	Left-Hand Drive
MAN	Manual gearbox
NTC	Negative Temperature Coefficient (the resistance decreases with rising temperature)
PTC	Positive Temperature Coefficient (the resistance increases with rising temperature)
RHD	Right-Hand Drive
SOP	Start of Production
SRS	SRS (Supplementary Restraint System)
TCS	Traction Control System
TTS	Twin Throttle System

Some simple testing methods

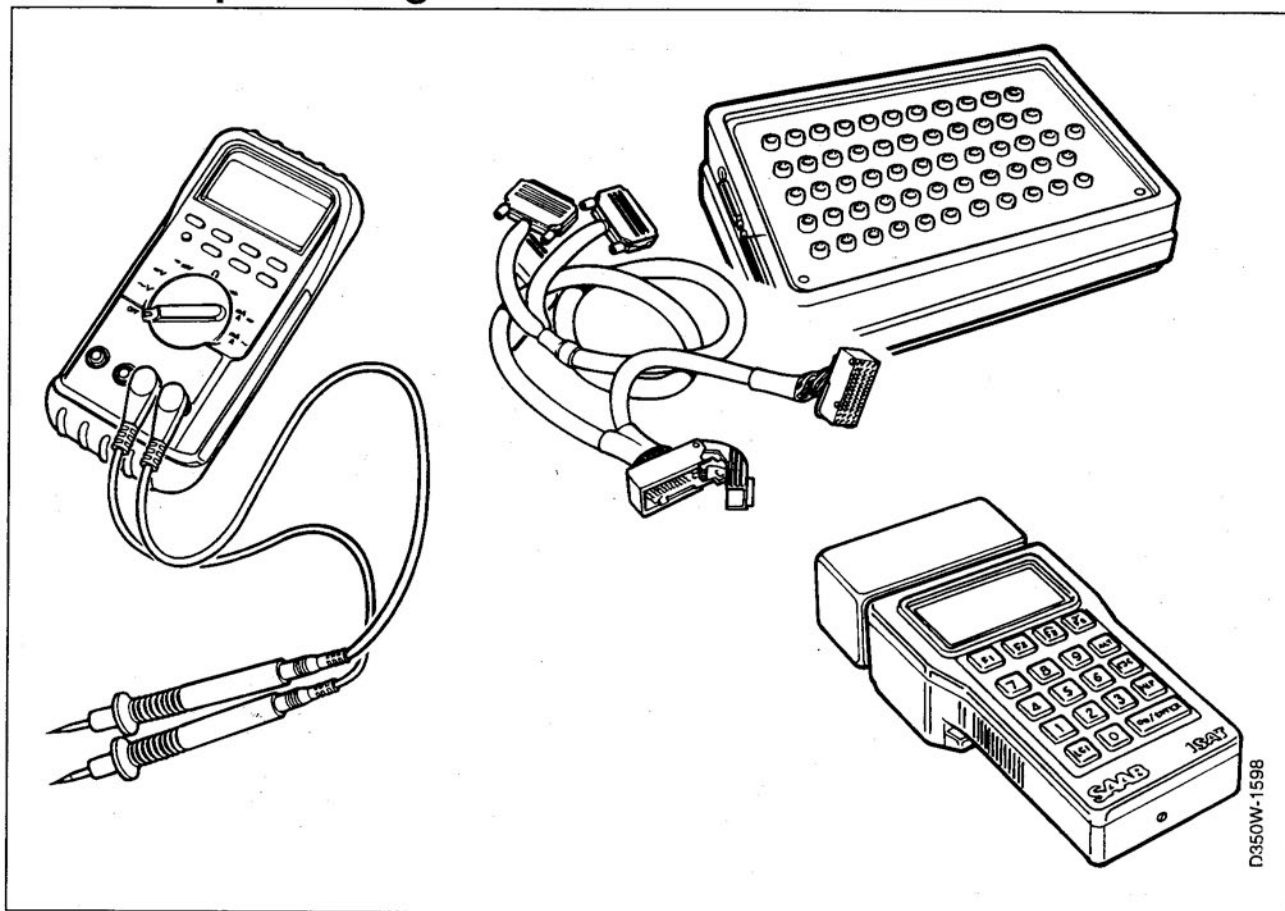

General

Suitable instruments for diagnosing faults in the car's electrical system are an ISAT Scan Tool, a voltmeter and an ohmmeter.

- Use an ISAT Scan Tool or voltmeter for measuring the voltage in a circuit.

If the voltmeter is of analogue type, it should have an internal resistance of at least 20 Megohm/V.

- Use an ISAT Scan Tool or ohmmeter for measuring the resistance of a circuit.

The ohmmeter must **not** be used for carrying out measurements on components containing semi-conductors such as control modules and time-delay relays, etc.

- When measuring resistance, the voltage supply to the system being tested must be disconnected as the test instrument supplies a small measuring current to the circuit being checked.

This will ensure that no current is already flowing through the circuit and that a correct reading will be obtained.

Some simple testing methods (contd.)

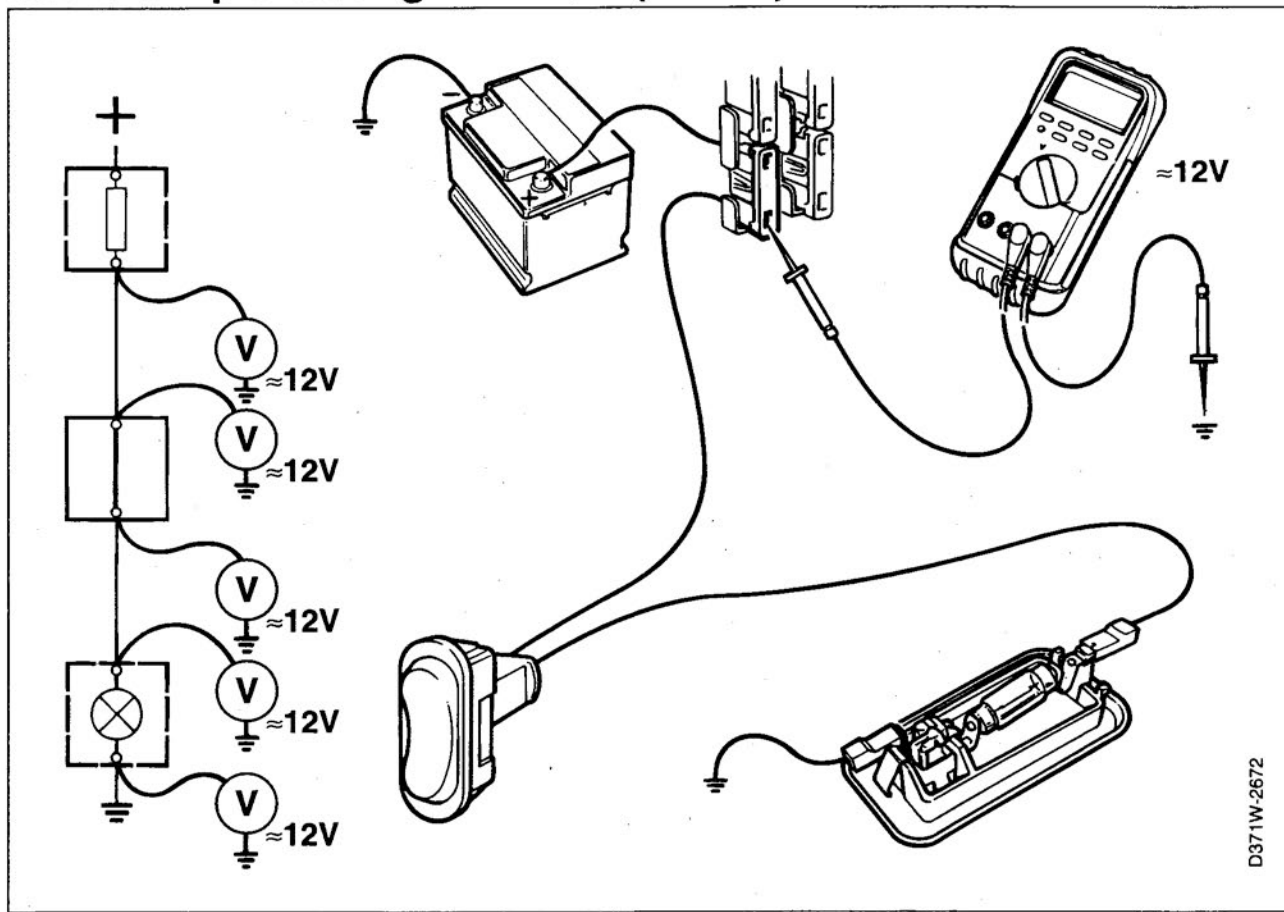

D371W-2672

Checking the voltage

- 1 Disconnect the load.
- 2 Connect the voltmeter's negative lead to a good grounding point.
- 3 Connect the voltmeter's positive lead to the connector pin that is to be checked.
- 4 If the voltage here should be the same as the battery voltage, it ought not to differ by more than about 1 V.

Some simple testing methods (contd.)

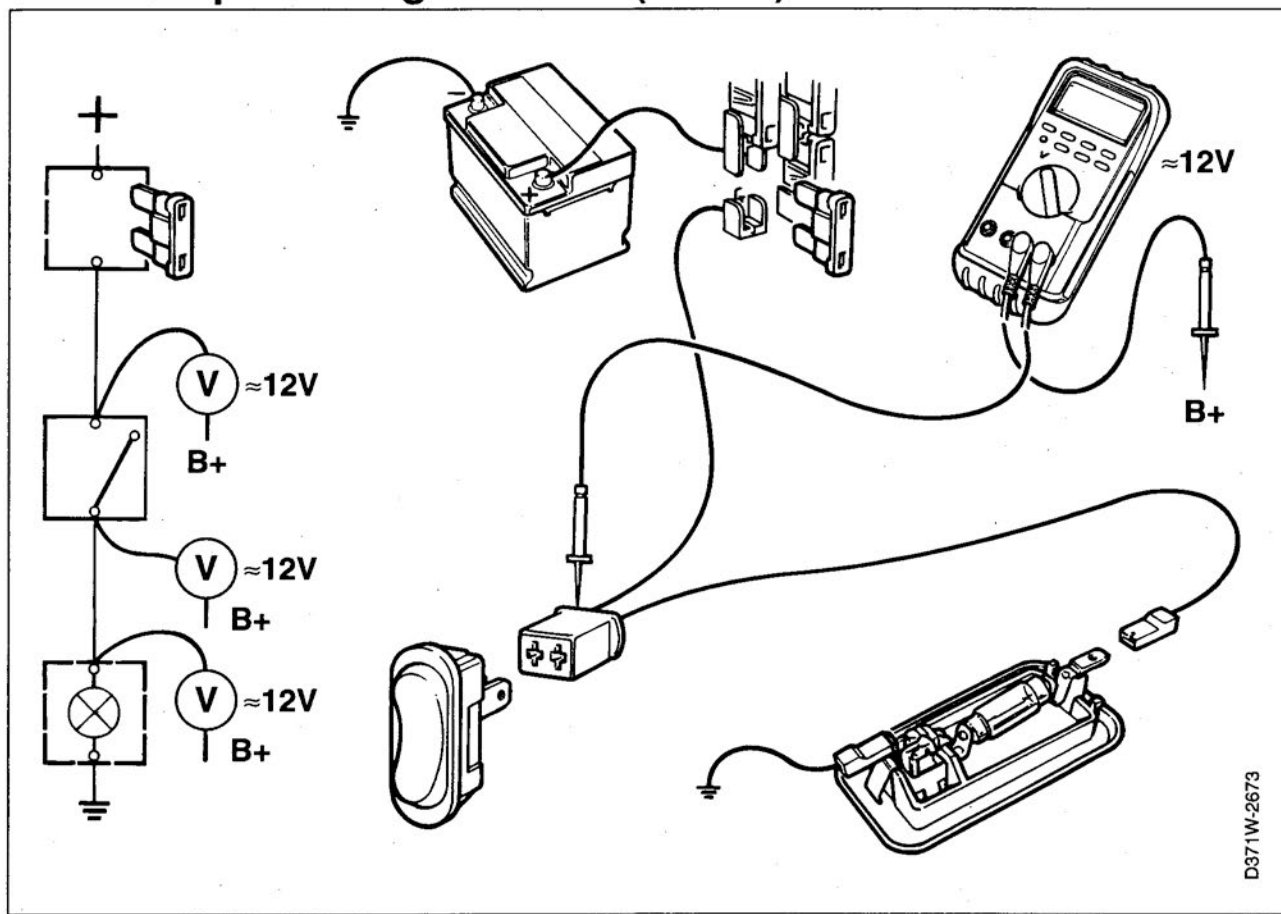

D371W-2673

Checking for short-circuit to power supply

- 1 Disconnect the fuse from the system to be checked.
- 2 Connect one of the voltmeter's leads to B+.
- 3 Connect the other voltmeter lead to the point in the circuit to be checked.

Take a reading on the load side of the wiring harness and work outwards to the circuit's grounding point.

- 4 If the voltmeter shows a reading, it indicates that voltage is present at the point concerned.

Some simple testing methods (contd.)

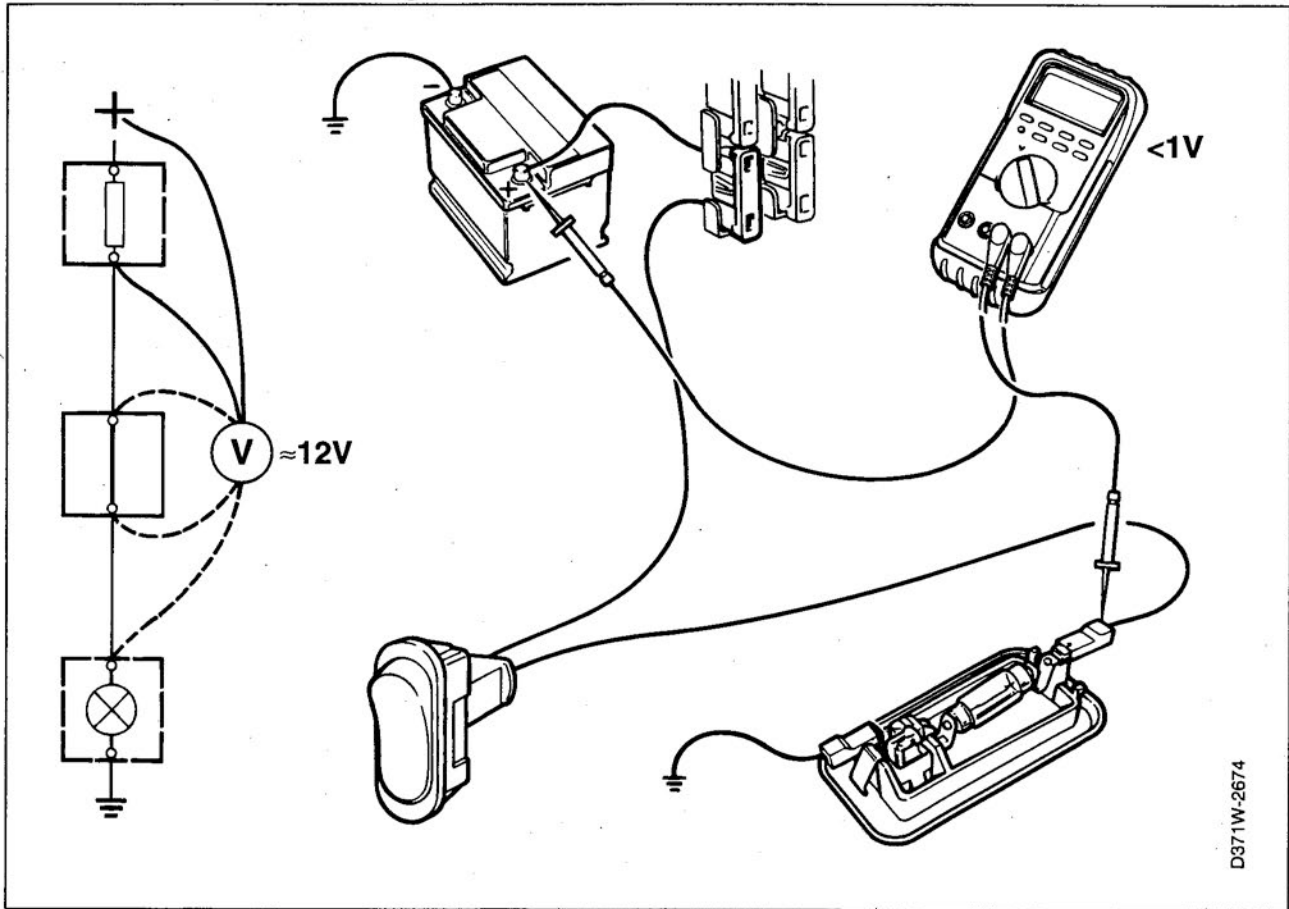

Checking a voltage drop

This method is used to ascertain whether the voltage drop in a wiring harness or across a component, etc., is too high.

- 1 Connect the voltmeter's positive lead to that part of the cable or component closest to the power supply.
- 2 Connect the voltmeter's negative lead step by step towards the load (item of electrical equipment), which should be switched on.
- 3 When the circuit is activated, i.e. when current flows through it, the voltmeter will show the difference in voltage between the two test points.

A circuit in perfect working order should not show a voltage drop of more than about 1 V.

In simple circuits or connectors, the voltage drop ought not to exceed about 0.5 V.

Some simple testing methods (contd.)

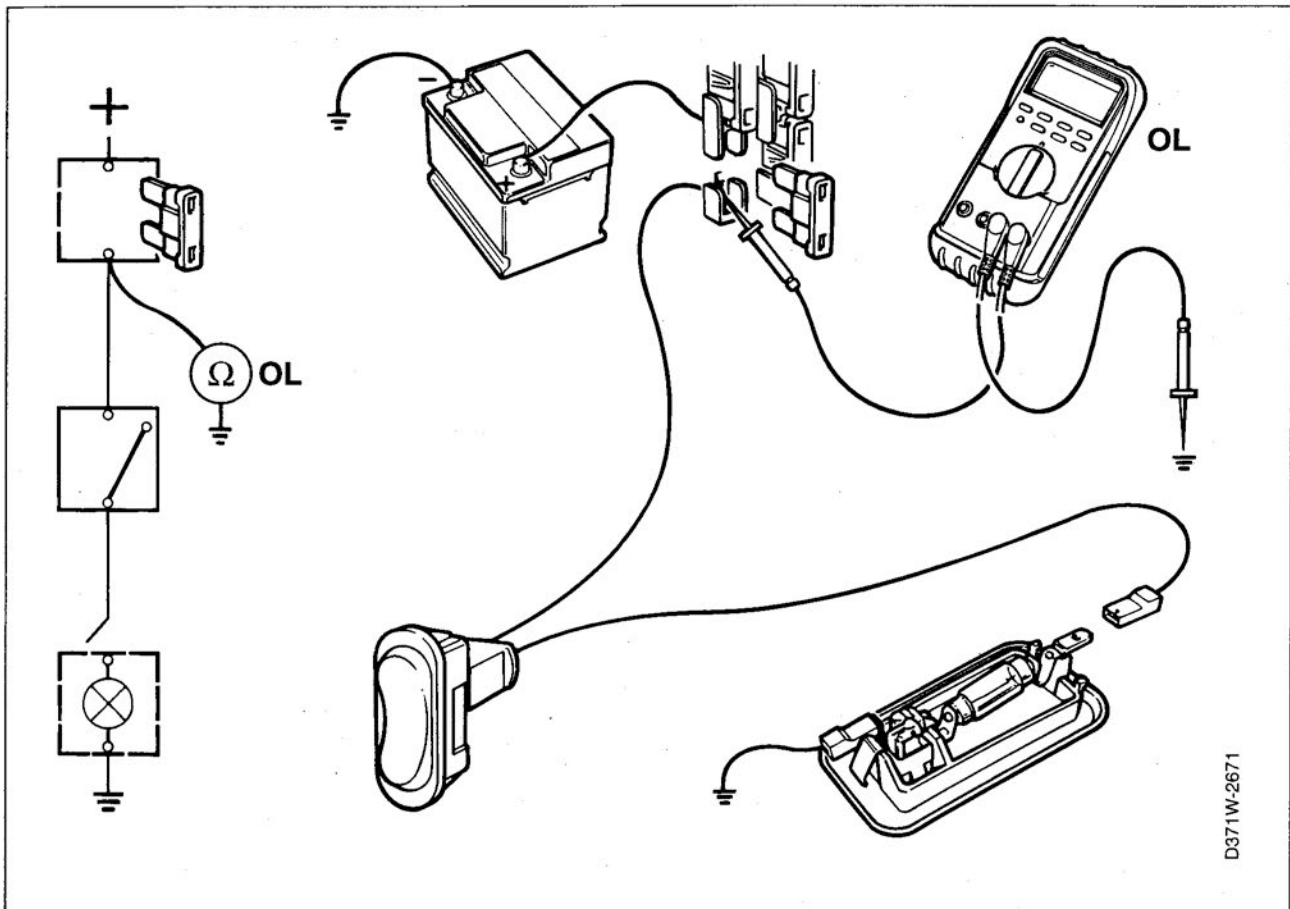

D371W-2671

Checking for short-circuit to ground

- 1 Hold the ohmmeter leads in contact with each other and adjust the instrument until a reading of 0 ohms is obtained.
- 2 Disconnect the load and the negative battery cable.
- 3 Connect one of the ohmmeter leads to the short-circuited cable's connection.
- 4 Connect the other lead to a good grounding point on the car.
- 5 Move the relevant wiring harness while observing the ohmmeter.

If the ohmmeter shows infinite resistance **OL** there is no short circuit.

On the other hand, if it shows low resistance or none at all, this indicates that the cable is short-circuited to ground.

Some simple testing methods (contd.)

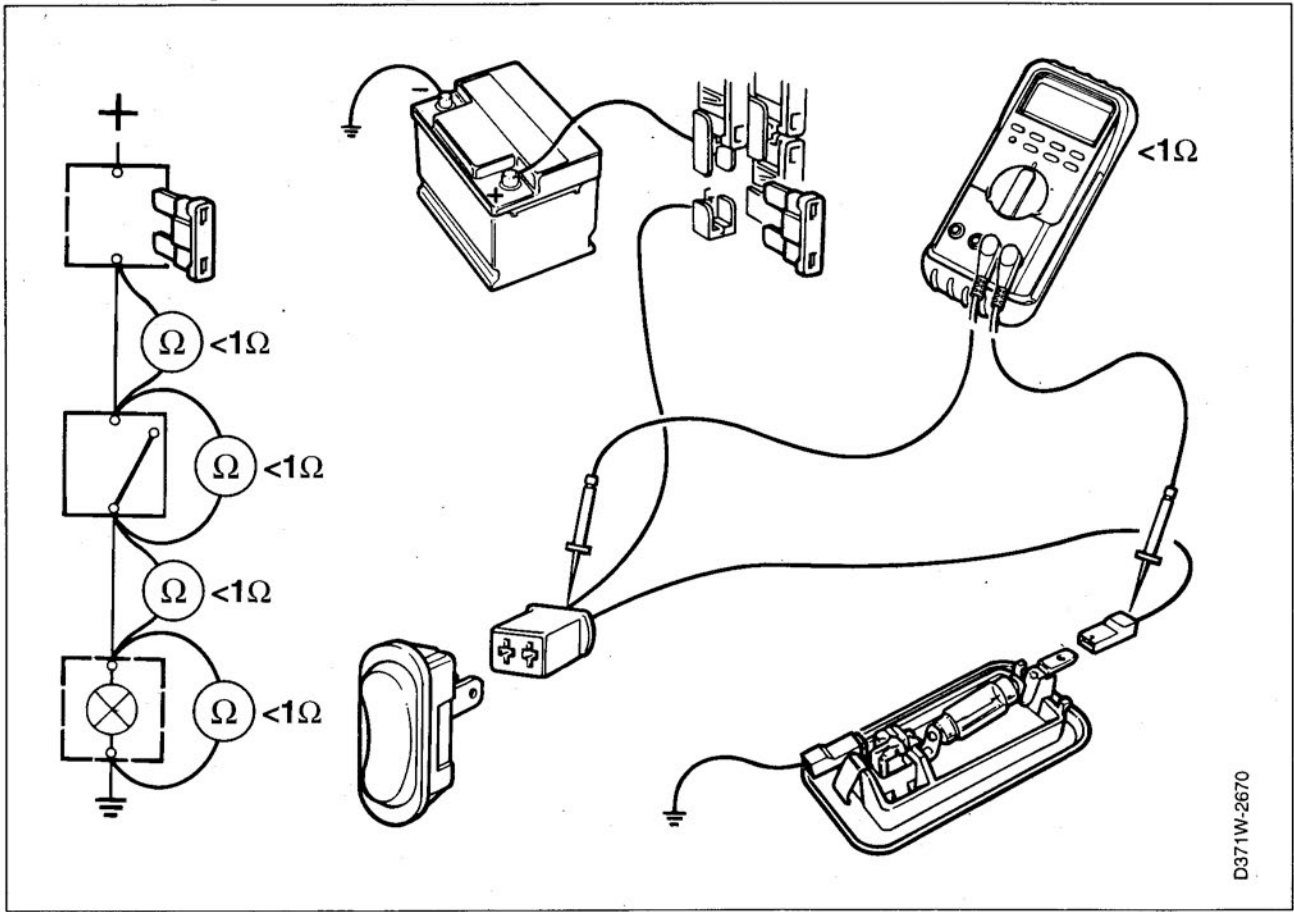

D371W-2670

Checking for open-circuit

Use an ohmmeter or ISAT Scan Tool set for resistance measurement.

- 1 Adjust the ohmmeter until a reading of 0 ohms is obtained when its leads are held in contact with each other.
- 2 Disconnect the power supply.
- 3 Connect the leads to each end of the wiring harness or component that is to be checked.
- 4 If the instrument shows a resistance < 1 ohm, there is no open-circuit.

PWM signals

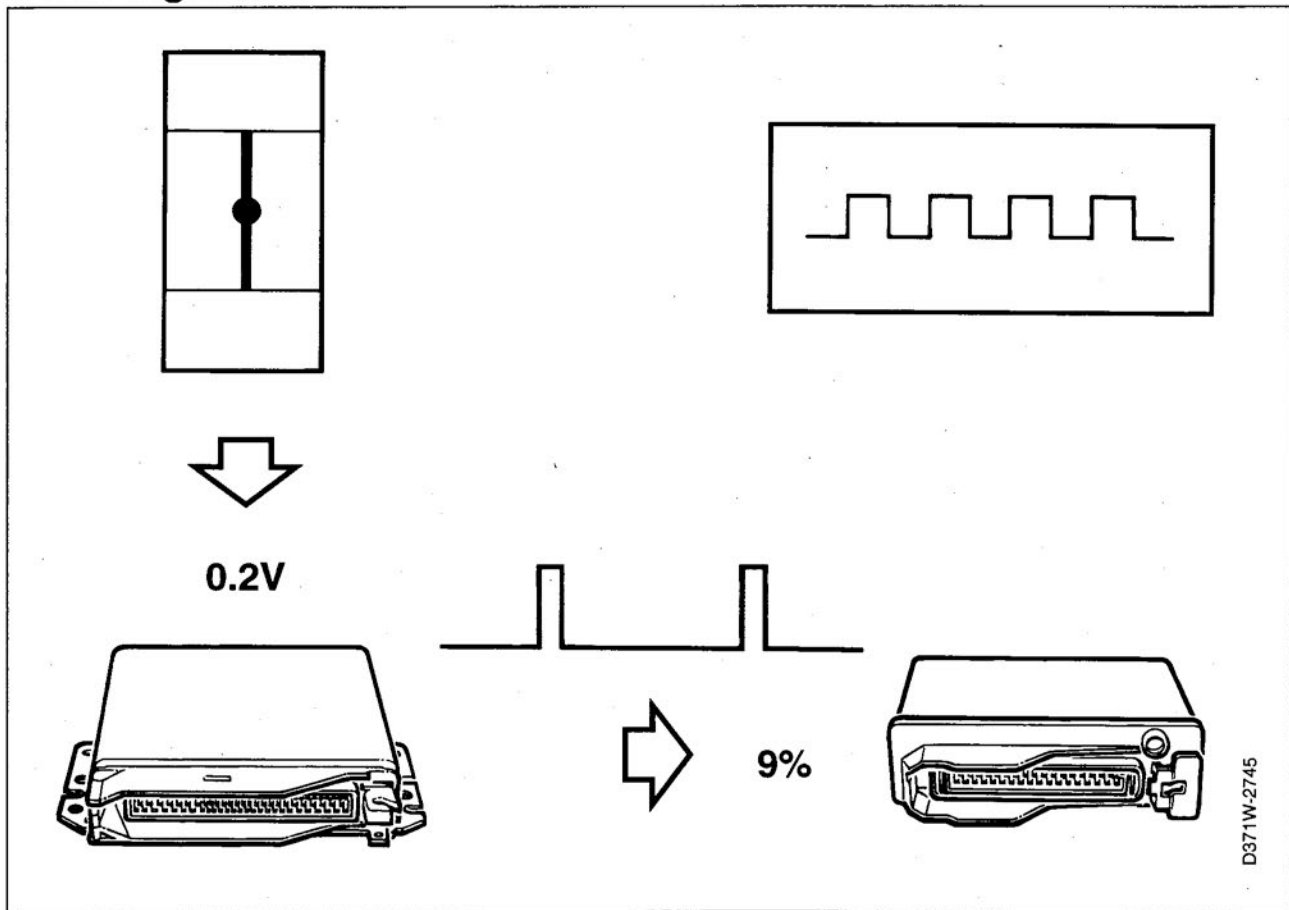

D371W-2745

Background

In modern cars it is often necessary to send information between different systems, and sometimes between systems of different makes. Analogue transfer of information has been found to be unreliable. Voltage drops in cables and connectors, as well as tolerances in the various control modules and their sensors, are some of the causes of this unreliability.

PWM (Pulse Width Modulation)

The solution to this problem is to use PWM signals. PWM stands for pulse width modulation, which means that it is the **time the cable is energized** that is important, not the voltage level.

The PWM signal can also be described as a square wave, where the width of the voltage pulses corresponds to the information. Since the voltage has only two states, on or off, the signal is said to be digital.

Example

A throttle position sensor sends a voltage to a Motronic control module. The voltage level depends on the position of the throttle valve, so that the voltage at closed throttle position may be around 0.2 V and at wide open throttle about 4.5 V. The voltage is thus proportional to the angle of the throttle butterfly valve and the value is said to be analogue.

Information about the throttle position can then be conveyed to other systems, such as the TCS, automatic transmission, etc., but as a PWM signal rather than an analogue voltage.

PWM signals in this case always have a pulse ratio (see page 19) of 9% in closed throttle position (higher when the accelerator is depressed), regardless of the voltage drop or tolerances.

PWM signals (contd.)

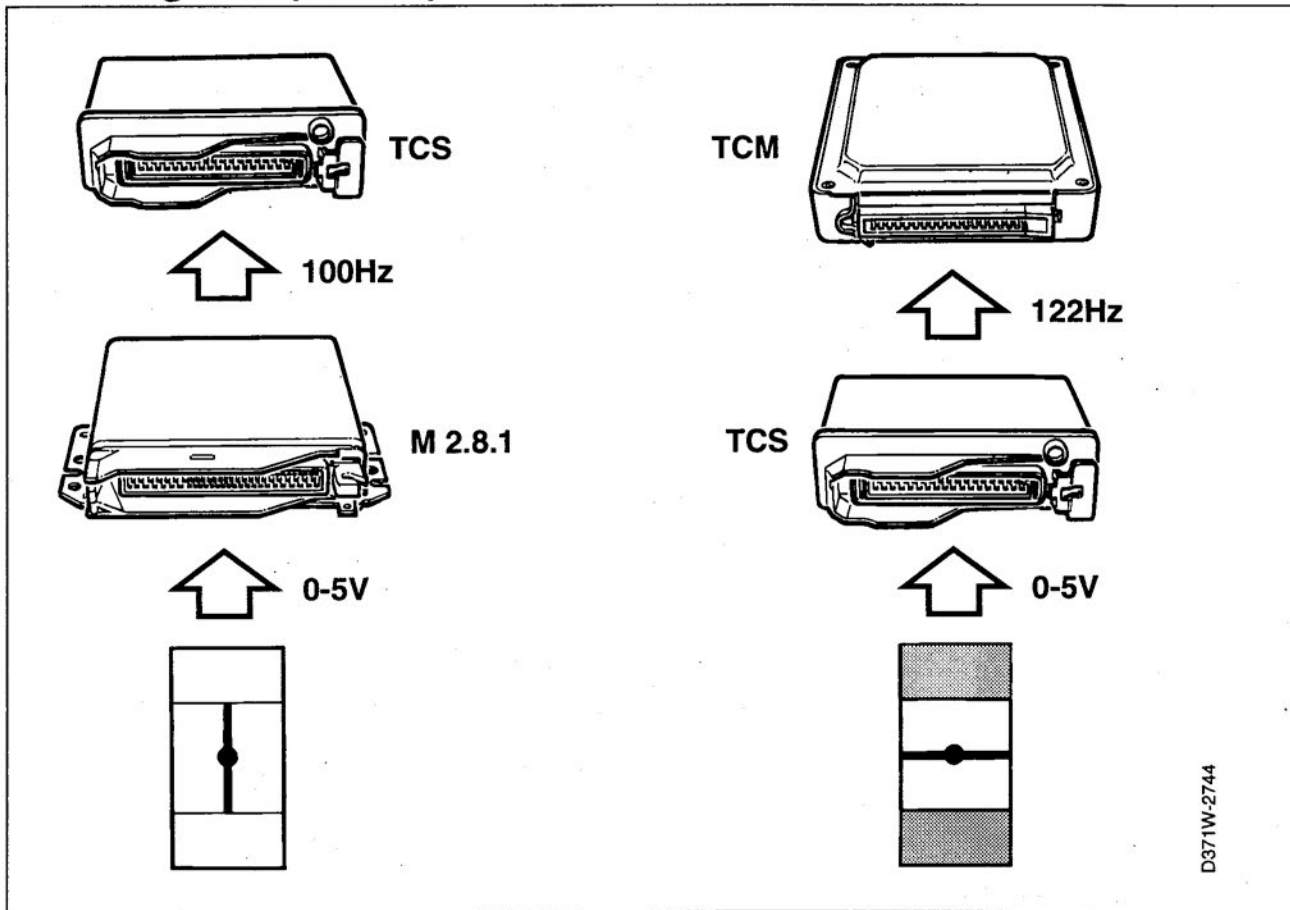

D371W-2744

PWM signal frequency

The information that is sent from one control module to another often changes very quickly and it must therefore also be possible to change the pulse width very quickly.

This also means that the pulses have to occur very often, i.e. the signal has to have a high frequency.

The PWM signal generally has a fixed frequency of between 75 and 225 Hz, which means that the pulses occur 75 to 225 times a second. *)

Common frequencies in cars are 100, 122 and 200 Hz for transmitting control modules while receiving control modules generally accept relatively wide deviations from these values. In this way we obtain very reliable communication.

*) In exceptional cases the frequency is not fixed, such as the engine load (Tq) signal from the TRIONIC system, the frequency of which depends on engine speed but the pulse width reflects the engine load.

PWM signals (contd.)

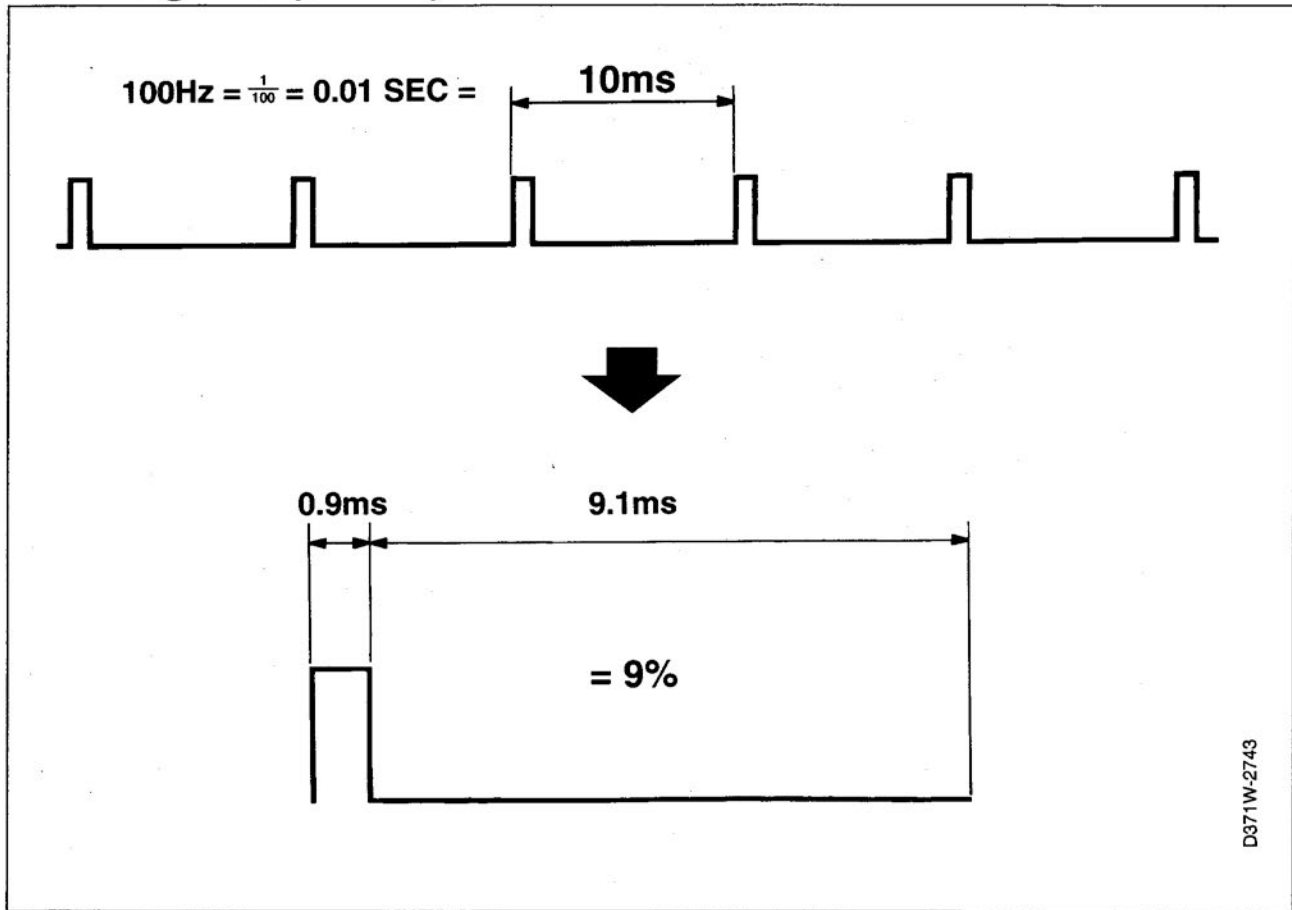

Characteristics of the PWM signal

Frequency

The actual frequency does not tell us anything about the value of the information carried by the cable but it can confirm that contact has been established with transmitting control modules and we can check whether the frequency is within reasonable limits.

Pulse length

At 100 Hz there are 100 pulses a second, which means that the **maximum** pulse length can be 1/100th of a second, i.e. 10 milliseconds. The pulse length at 100 Hz can therefore vary between 0 and 10 milliseconds.

Pulse ratio

If we have a pulse length of 0.9 ms at 100 Hz, it is said that the pulse ratio is 9% (the duration of the pulse is 0.9 ms out of a possible 10 ms). When information is being transmitted, the pulse ratio is between 8% and 92%.

PWM signals (contd.)

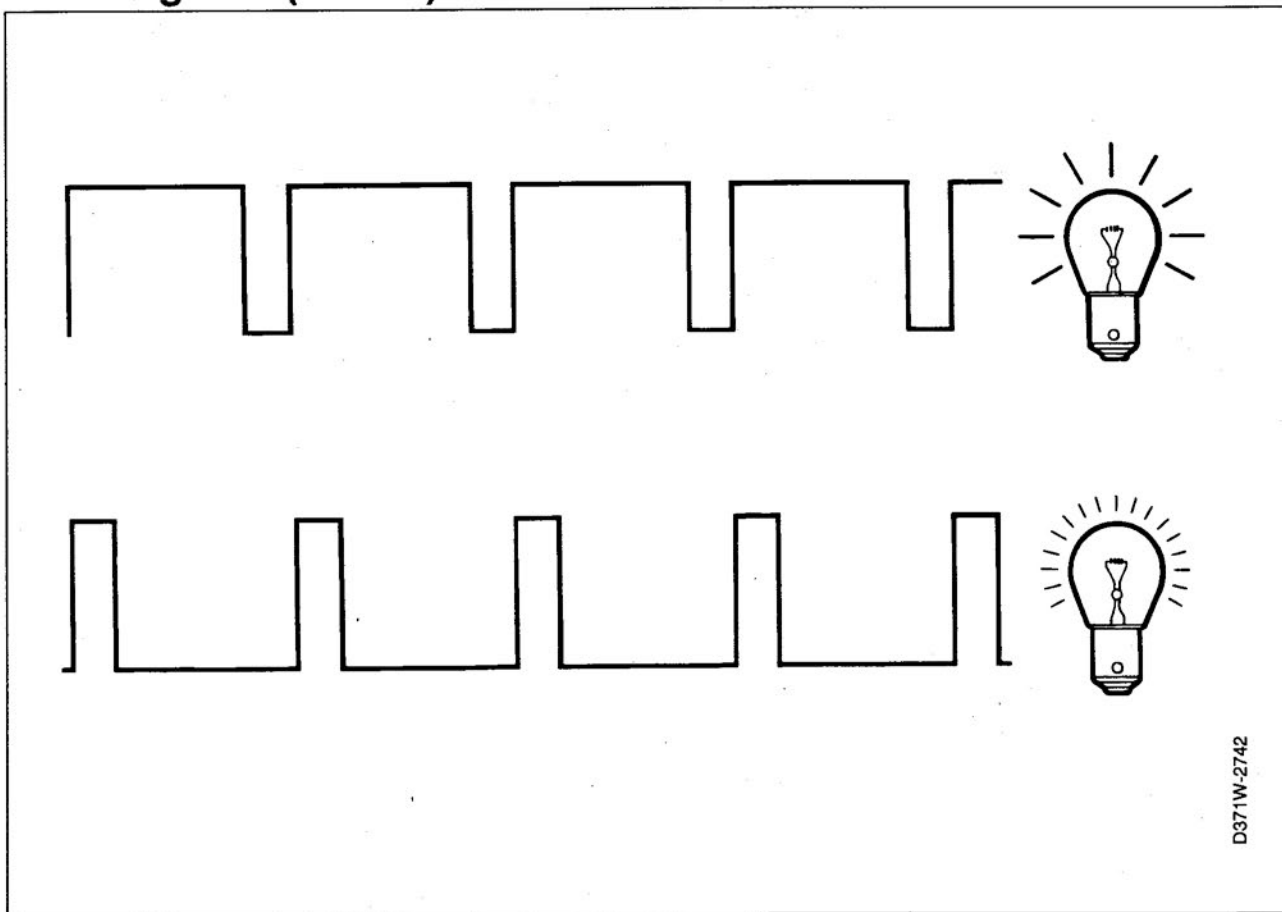

D371W-2742

When the PWM signal is not to be regarded as a signal

The PWM technique can also be used for purposes other than transferring information between control modules. PWM can be sent direct to a consumer in the system, in which case we do not refer to PWM as a PWM signal because it is not information as such that is transmitted.

One example is the instrument lighting which is supplied with PWM voltage, where a low pulse ratio causes the lamps to shine dimly while a higher pulse ratio increases their brightness. Since the frequency is high, the eye cannot perceive that the lamps are "flashing".

Other examples are the throttle actuator motor, the IAC valve, the boost pressure control valve for the APC and the EVAP canister purge valve.

It can also be said that the power supplied to the injectors is pulse width modulated, as the pulse width corresponds to the time the valves are open.

In the above examples we refer to PWM outputs (the transmitter) and PWM inputs (the receiver). The system manufacturer has a free choice of frequencies and pulse ratios with regard to these inputs and outputs. Some common frequencies are 70-90 Hz for the boost pressure control valve in the TRIONIC engine management system, 56-90 Hz for the instrument lighting and 500 Hz for the throttle actuator motor of the TCS system.

Fuses and relays

General information about fuses

The car's 12 V power supply is fed to the various consumer units via three main fuse boxes, one behind the glove box, one in the engine bay by the left-hand headlamp and one for the ABS brakes in the engine bay on the bulkhead partition. Most of the fuses and relays are located in the main fuse boxes.

The fuses are of blade type and, together with their connecting sockets, cause a lower voltage drop than earlier types. They are also more resistant to corrosion.

Blade fuse colour coding:

Fuse	Colour
5A	Light brown
7,5A.	Dark brown
10A	Red
15A	Blue
20A	Yellow
25A	Transparent
30A	Green

Checking blade fuses

Each blade fuse has test sockets which can be used to check that the fuse is intact without the need to remove it. If both sockets are live, the fuse is intact.

On a fuse that has been removed it is possible to see whether it has blown.

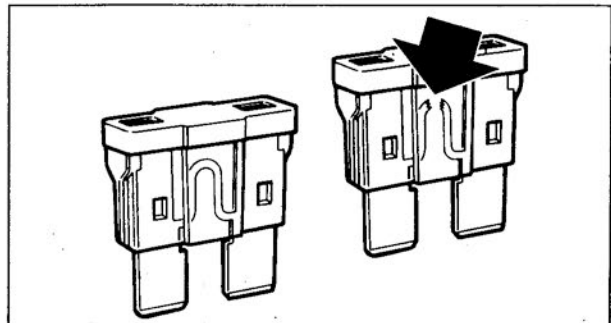

Main fuse box, glove box

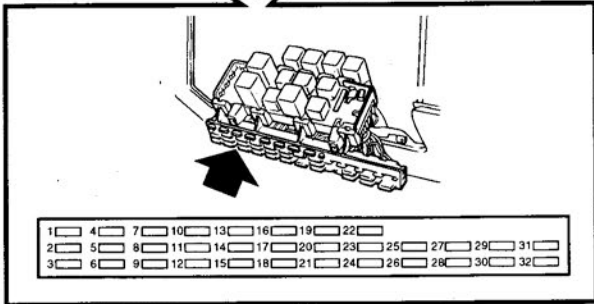
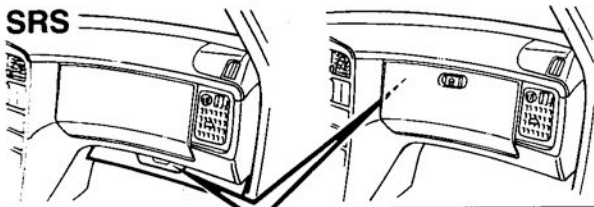

C0371-D0001

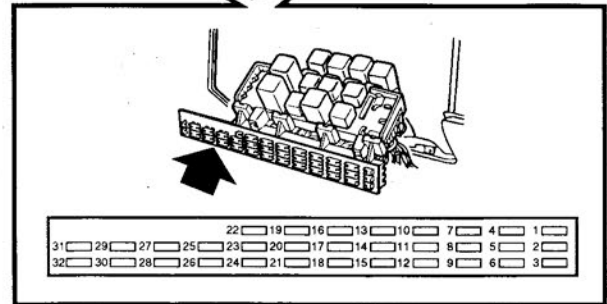
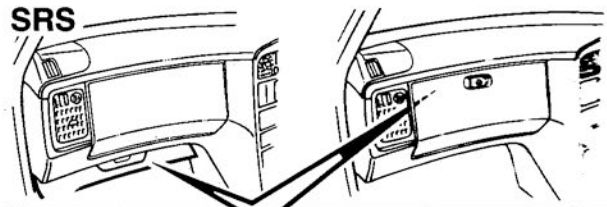

C0371-D0002

Fuse table

No.	Rating	Function
1	5A	ACC control module, A/C
2	10A	Cruise Control, electrically adjustable door mirrors
3	10A	Seat-belt warning, reading lights,
4	5A	Airbag
5	10A	APC system
6	30A	Ventilation fan
7	10A	Headlamp wipers, horn switch
8	20A	Windscreen wipers, rear window wipers
9	30A	Rear electric window lifts, sun roof, reversing lights, cigarette lighter.
10	20A	Electrically heated front seats
11	30A	Front electric window lifts/ headlamps
12	15A	Direction indicators, headlamp beam adjustment
13	10A	Instrument, EDU, fuel system (+15 circuit), ETS
14	20A	Fuel pump
15	5A	Electronic throttle actuator
16	15A	Central locking, delayed interior lighting, courtesy lights, reversing lights

17	10A	ACC, EDU
18	30A	Electrically heated rear window
19	15A	Radio, electrically operated aerial/ clock/ SCC
20		Pre-wiring for telephone
21	25A	Electronic throttle actuator
22	15A	Hazard flashers
23	5A	Data link connector, engine and car electronic circuitry
24	15A	Brake lights
25	30A	Electrically adjustable driver's seat
26	30A	Electrically adjustable passenger's seat
27	10A	Radio, P-interlock
28	10A	Heated oxygen sensor
29	15A	Parking light (right-hand), lighting for controls and instruments
30	10A	Parking light (left-hand), glove box lighting
31	15A	Daylight driving lights
32	15A	Rear fog light

Main fuse box, glove box

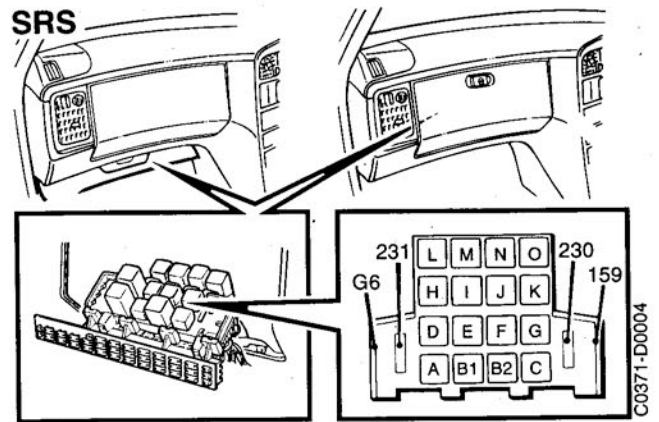
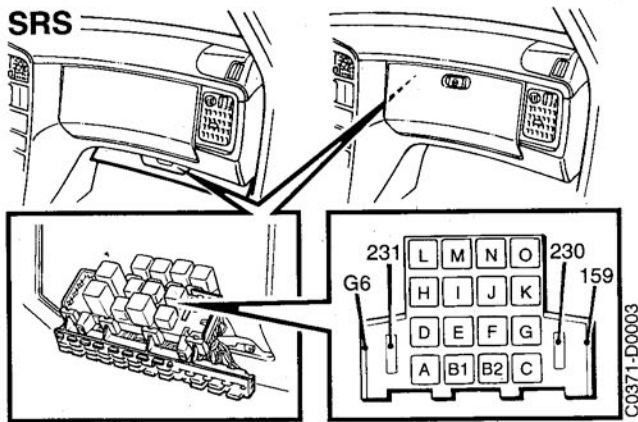

Relay table

Location No.	Function
A 82	Seat-belt/ ignition key warning
B1 437	P-interlock
B2 83A	Rear window wiper, intermittent operation
C 432	Washer pump, rear
D 102	Fuel pump
E	
F 405	Reversing lights
G 21	Ignition switch
H 229	Engine management system
I 113	Electrically heated rear window
J 377	Electronic throttle actuator (ETS)
K 452	Starter motor interlock
L 83	Windscreen wiper, intermittent operation
M 151	Interior lighting with time delay
N 23	Direction indicators
O 174	Daylight driving lights US/CA

159 Distribution terminal, +15 circuit
 230 Distribution terminal +30 circuit
 231 Distribution terminal +54 circuit
 G6 Distribution terminal, negative

Main fuse box, engine bay

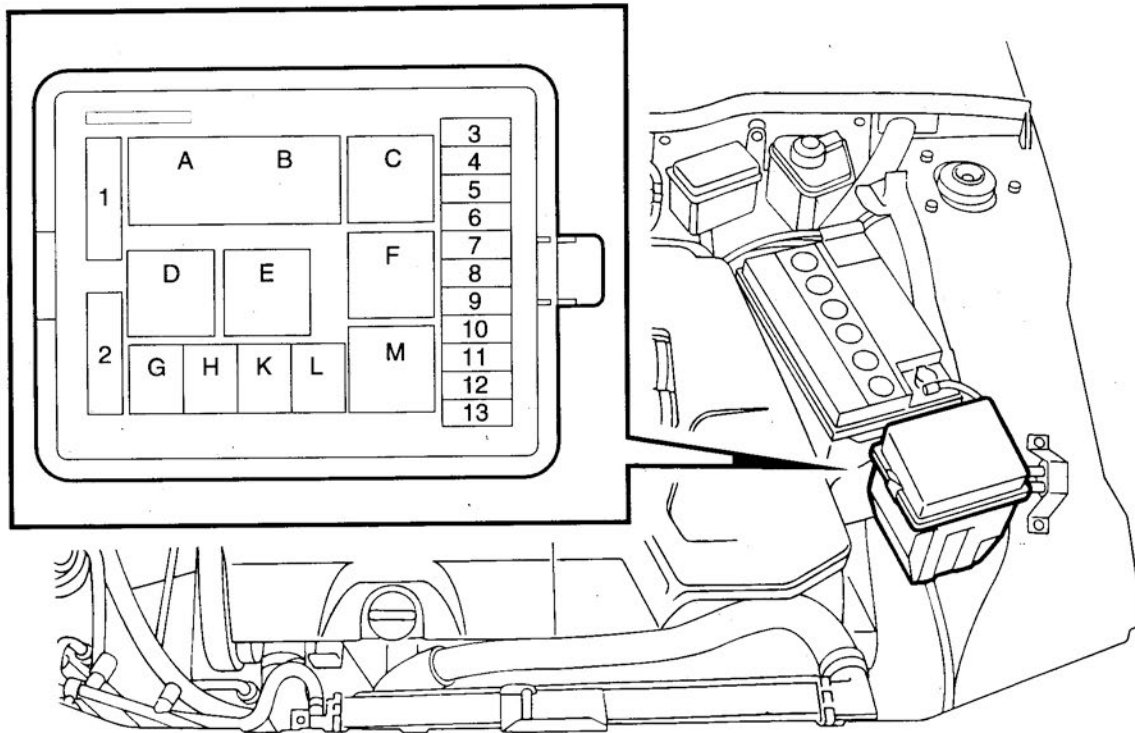

C371W-4579

Fuse table

No.	Rating	Function
1	30 A MAXI	Air pump
2	30 A MAXI	Radiator fan, high speed
3	5 A	Two-speed radiator fan relay
4	40 A	Radiator fan, low speed
5	15 A	Dipped beam, left-hand
6	15 A	Dipped beam, right-hand
7	15 A	Full beam, left-hand
8	15 A	Full beam, right-hand
9	5 A	Horn relay
10	25 A	Horn
11	30 A	A/C
12	15 A	Fog lights
13	10 A	Secondary air injection control valve

Relay table

Location No.	Function
A 8	Full and dipped beams
B 8	Full and dipped beams
C 228B	Filament monitor
D 324	Air pump
E 81	2-speed radiator fan, high speed
F 156	A/C
G 107	Fog lights
H 433	Radiator fan disengagement
K 78	Dimmed dipped beam
L 68	Horn
M 155	2-speed radiator fan, low speed

Electrical distribution box ABS/TCS

(behind the brake fluid reservoir)

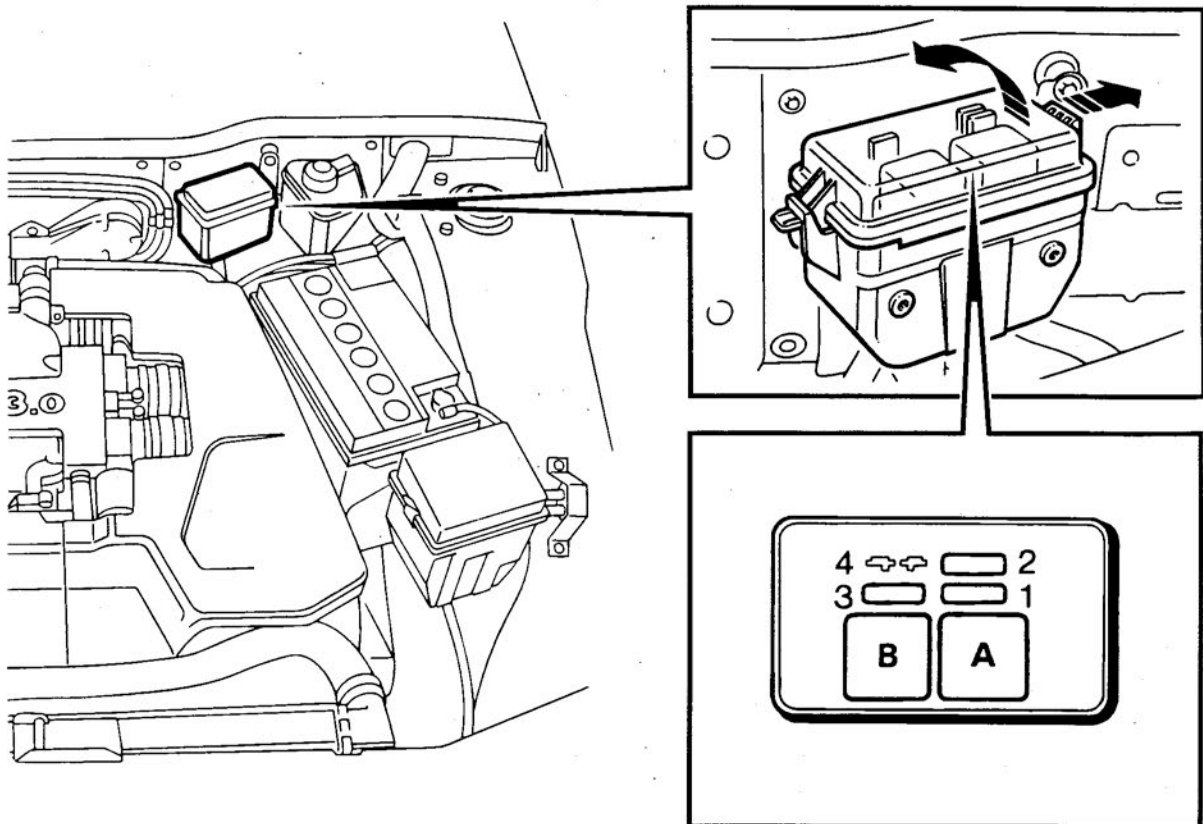

C371W-4580

Fuse table

No.	Rating	Function
1	30A	Pump relay ABS-TC/ ABS
2	30A	Main relay ABS-TC/ABS
3	10A	Pump relay and control module ABS-TC/ABS
4		Spare

Relay table

Location No.	Function
A 293	Pump relay ABS-TC/ ABS
B 292	Main relay ABS-TC/ABS

Other relay locations

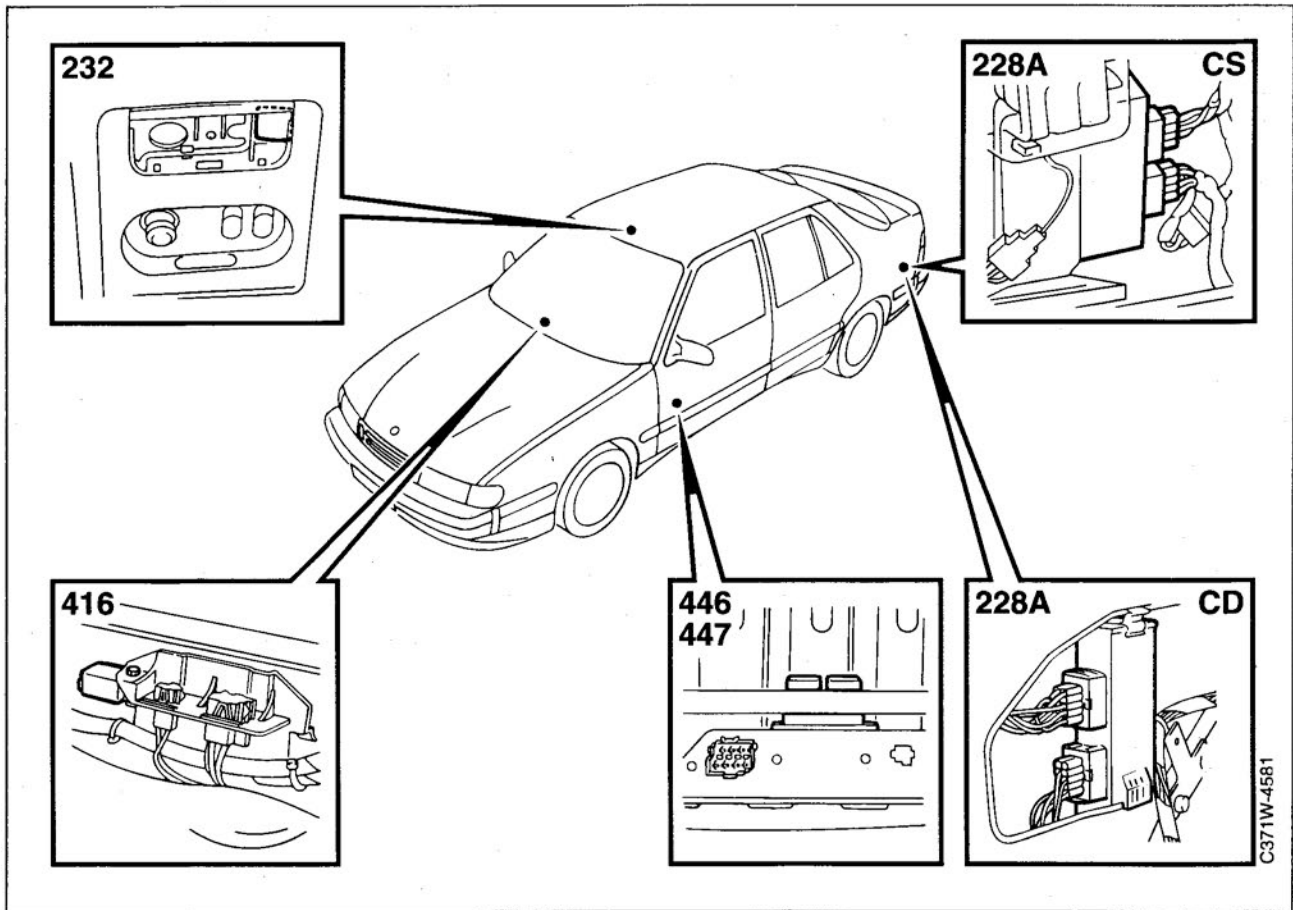

C371W-4581

Component	Location
228A	Luggage compartment filament monitor, on the left-hand side behind the trim in the luggage compartment
232	Stepping relay for electrically operated sunroof, in the roof console beside the sunroof
416	EXH warning relay, on a bracket behind the front seat member on the right-hand side
446	Electrically adjustable seat relay (ignition switch), on the seat frame under the seat cushion.
447	Electrically adjustable seat relay (door switch), on the seat frame under the seat cushion.

Grounding points

General information about grounding points

There are two main types of grounding point in the car, those with a component number and those where a component is grounded directly to the chassis, such as temperature sensors and oil pressure sensors.

The car battery is grounded via two cables. One cable has a cross section area of 25 mm² and goes directly to grounding point G25 (on the gearbox). The other has a cross-section area of 16 mm² and goes to grounding point G2, which is located behind the battery on the left-hand wheel housing.

From grounding point G2, a lead goes to distribution terminal 158 (negative), which is located in the main fuse box behind the glove box.

For radio interference suppression, a braided grounding strap is connected between the engine mounting and the car body.

Grounding points having a component number are covered in this section.

Note

Due to different market specifications, some cars may not have all the grounding points listed.

G2	Battery tray grounding point
----	------------------------------

G3	Luggage compartment grounding point, left-hand
----	--

G4	Luggage compartment grounding point, CS
----	---

G5	Rear seat grounding point
----	---------------------------

G6	Distribution terminal, negative (in relay box 22A)
----	--

G7	Engine grounding point
----	------------------------

G8	Dashboard grounding point, stiffening member
----	--

G14	Grounding point, left-hand front seat member
-----	--

G15	ABS control module grounding point
-----	------------------------------------

G16	ABS grounding point
-----	---------------------

G20	Airbag control module grounding point
-----	---------------------------------------

G24	Grounding point, right-hand front seat member.
-----	--

G25	Gearbox grounding point
-----	-------------------------

G26	Right-hand C pillar grounding point
-----	-------------------------------------

G27	Electrically operated aerial grounding point
-----	--

G29	Luggage compartment grounding point, right-hand
-----	---

G30	Structural member grounding point, left-hand
-----	--

G31	Structural member grounding point, right-hand
-----	---

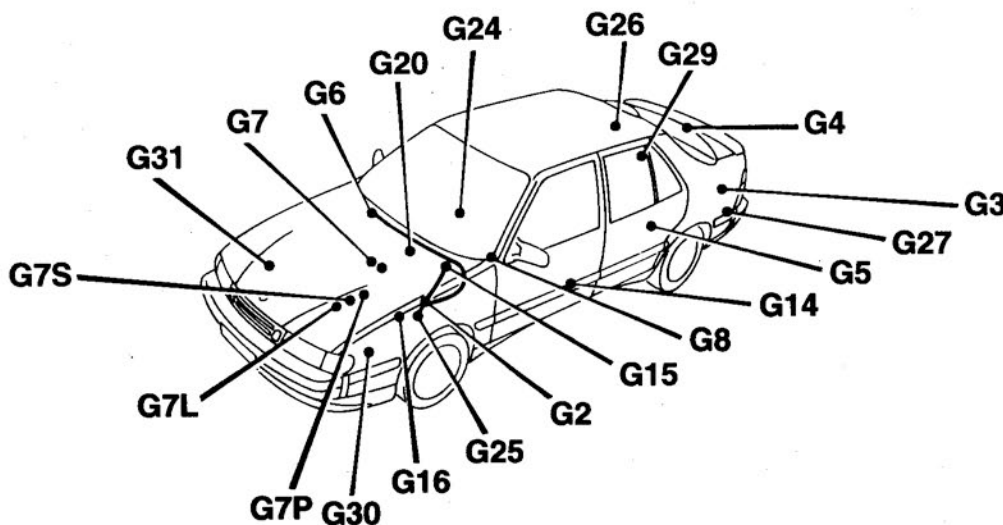

C371W-4582

Grounding points G2, G25

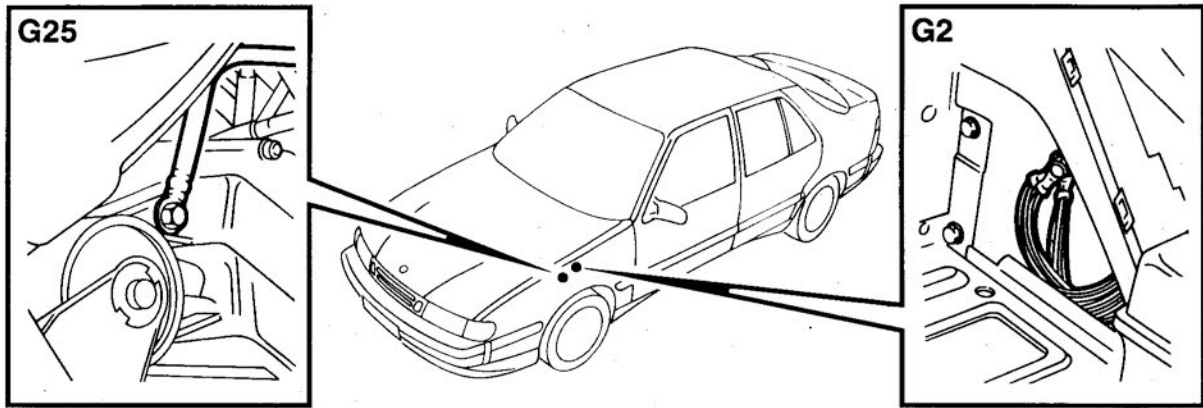

Grounding point **G2** is located behind the battery on the left-hand wheel housing. The following components are connected to the grounding point:

- 1 Battery
- 36 Motor, ventilation fan
- 42 Brake fluid level warning switch
- 62 Windscreen wiper motor
- 220 Speed control for ACC ventilation fan
- 243 Engine oil level switch
- 275 Siren, anti-theft alarm
- 282 Headlamp beam adjustment switch
- 453 Coolant circulation pump, V6
- 508 Cruise Control system control module
- G6 Negative distribution terminal
- G25 Gearbox grounding point

Grounding points G5, G6

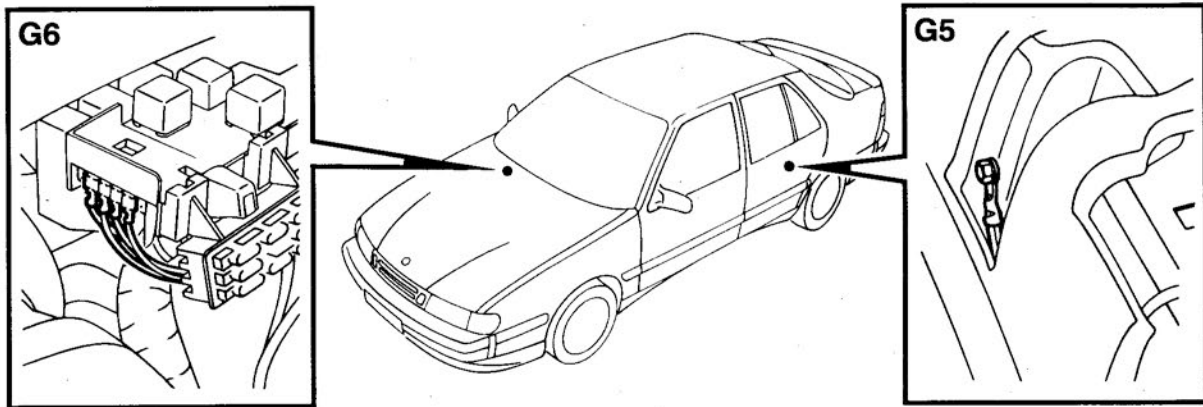

Negative distribution terminal **G6** is located in the left-hand part of the main fuse box. The following components are connected:

- 19 Glove box lamp
- 21 Ignition switch relay
- 23 Direction indicator relay
- 25 Hazard flashers switch
- 82 Seat-belt/ignition key warning relay
- 83 Windscreen wiper intermittent operation relay
- 83A Rear window wiper intermittent operation relay
- 113 Electrically heated rear window, relay/time-delay relay
- 116 Electrically heated rear window switch
- 127 Motor, electrically adjustable door mirror, right-hand
- 143 Recirculation switch, A/C
- 151 Interior lighting time delay relay
- 154 Lighting, heater controls
- 169 A/C switch
- 174 Relay, daylight driving lights
- 207 Electrically heated door mirror, passenger's door
- 208 Lock indication, passenger's door
- 289 Control module, anti-theft alarm
- 274 Microswitch, driver's door
- 405 Reversing light relay, automatic transmission
- 433 Relay, for disengagement of radiator fan
- 435 Microswitch in passenger's door
- 437 Relay, SHIFT LOCK P-interlock
- 452 Starter interlock relay, anti-theft alarm

In addition, grounding point **G6** is connected to grounding point G2.

The following components are connected to grounding point **G5** under the left-hand part of the rear seat:

- 15 Number plate lighting CD
- 32 Reversing lights
- 33 Rear fog light CD
- 56 Luggage compartment light switch
- 62A Rear window wiper motor
- 109 High-level brake light CD
- 188 Motor, central locking system, tailgate
- 208 Lock indication, left-hand rear door
- 228A Filament monitor, luggage compartment
- 247 Fan, left-hand rear door
- 323 Fuel pump with integrated feeder pump
- 418 Reversing light fitting CS
- 507 TTS control module

Grounding point G7

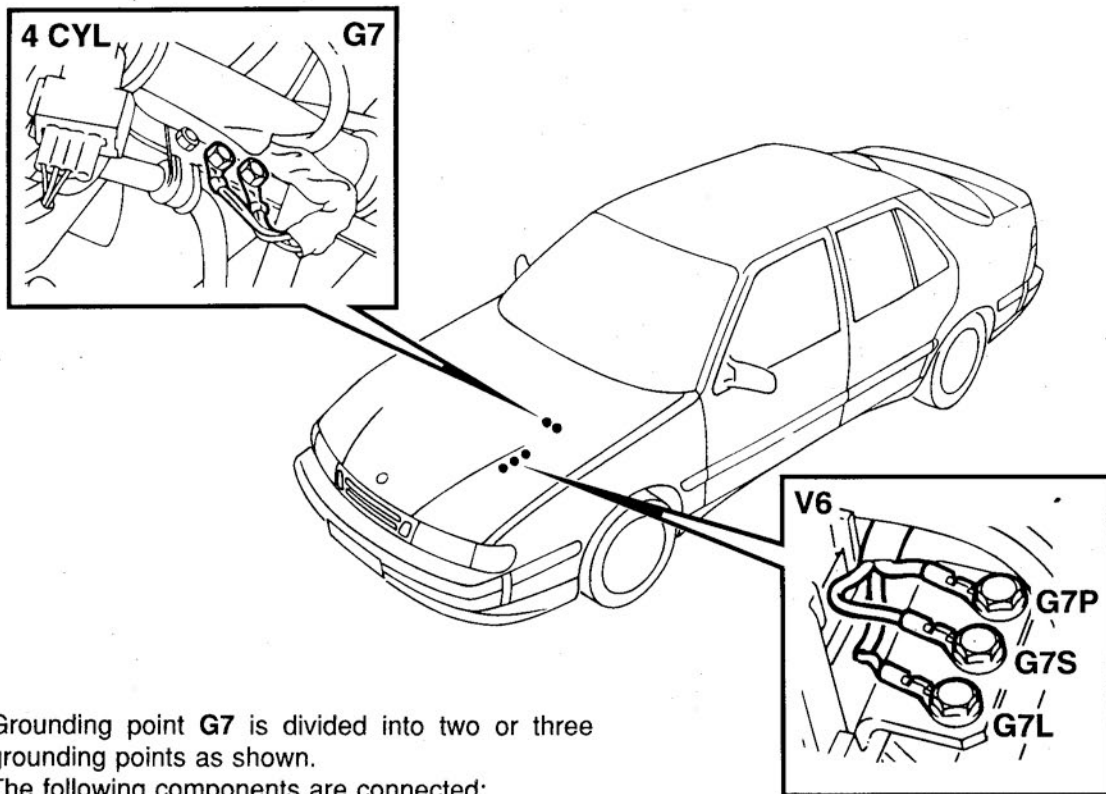

Grounding point **G7** is divided into two or three grounding points as shown.

The following components are connected:

- 205 Mass air flow sensor
- 271 Preheating element, oxygen sensor
- 346 Ignition discharge module, DI
- 376 ETS control module
- 414 ASR control module
- 430 Saab Trionic control module
- 444 Saab Trionic data link connector (for production only)
- 510 Motronic 2.8.1 control module

C371W-4585

Grounding point G8

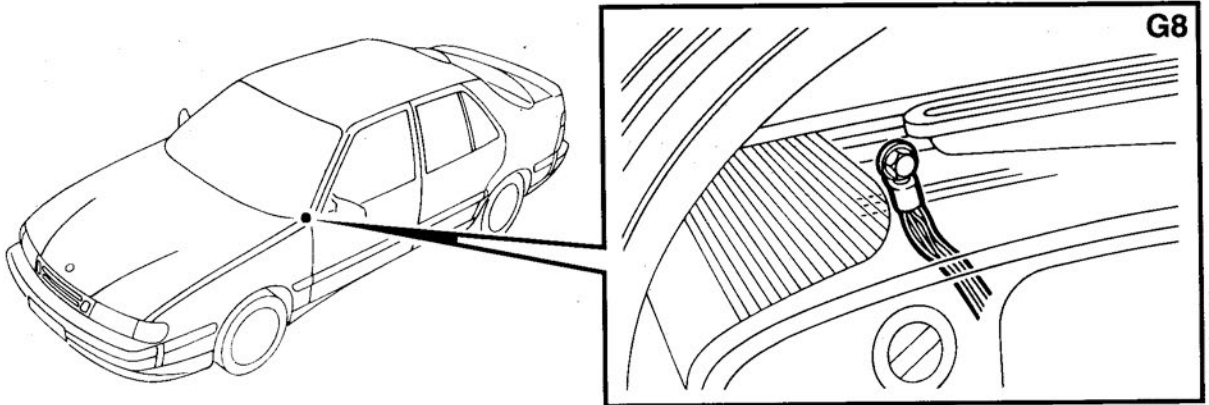

Grounding point **G8** is located behind the dashboard under the left-hand speaker grille on the stiffening member. The following components are connected:

10	Lights switch	210	EDU trip computer
16	Rheostat, instrument lighting	215	Dipswitch
18	Instrument lighting	216	Climate control unit, ACC
20	Ignition switch	219	Suction fan, interior temperature sensor
41	Horn switch	225	Reading light, rear seat
47A	Fuel gauge, cars without EDU (via a 4-pin connector by the fuel pump)	226	Reading light, front seat
47C	Temperature gauge	241	SCC trip computer
47G	Full beam indicator lamp	252	Rheostat, left-hand heating pad
47H	Direction indicator repeater lamp, left-hand	253	Rheostat, right-hand heating pad
47I	Direction indicator repeater lamp, right-hand	267	Radio connection
47J	Electrically heated rear window, indicator lamp	305	Light-emitting diode, anti-theft alarm
47N	Rear fog light indicator lamp	336	Slip ring contact, airbag
47U	Cruise Control, indicator lamp	352	Slip ring contact, horn
47V	Lights-on indicator lamp	354	Radio amplifier
48	Cigarette lighter	356	Speed warning control module
49	Clock	375	Connector, pre-wired telephone installation
53	Interior lighting switch	432	Relay, rear window washer
88	Extra fog lights switch	449	TCS switch
89	Side direction indicator, left-hand		
90	Side direction indicator, right-hand		
110	Tachometer (rev counter)		
124	Switch for electrically adjustable door mirrors		
126	Motor, electrically adjustable door mirror, left-hand side, LHD		
127	Motor, electrically adjustable door mirror, right-hand side, RHD		
132	Vehicle speed sensor (via a 3-pin connector, ME)		
148	Ashtray lighting, front cigarette lighter		
161	Rear fog light switch		
175	Central locking system control module		
207	Electrically heated door mirrors		
208	Lock indication, driver's door		

Grounding points G14, G15

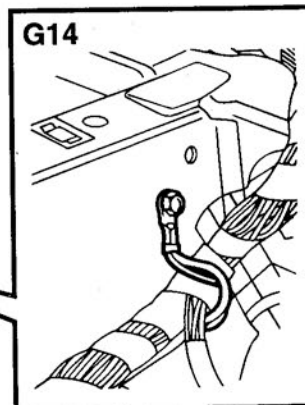
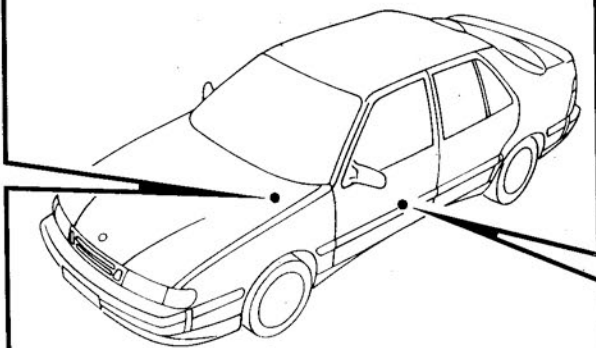
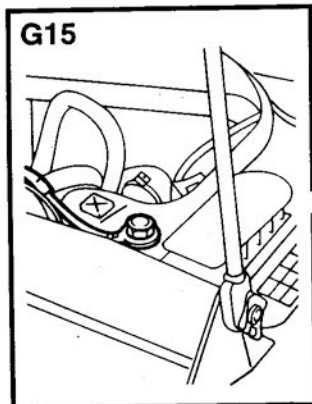

C371W-4587

The following components are connected to grounding point **G15** beside the ABS control module:

- 291 Control module, ABS
- 292 Main relay, ABS
- 382 TC-ABS control module

Grounding point **G14** is located in the left-hand seat member under the carpet on the left-hand side. The following components are connected:

- 64 Heating pad
- 70 Seat-belt switch, left-hand
- 224 Lighting, seat-belt buckle
- 245 Selector lever position switch, automatic transmission
- 254 Temperature sensor, heating pad, left-hand
- 357 Switch, electrically adjustable seat, left-hand
- 357K Control module, electrically adjustable seat with memory, left-hand
- 369 Microswitch, electrically adjustable seat backrest, left-hand
- 386 Switches, electric window lifts, electrically operated sunroof
- 446 Relay, electrically adjustable seat (ignition switch), left-hand
- 447 Relay, electrically adjustable seat (door switch), left-hand

Grounding points G16, G20, G24

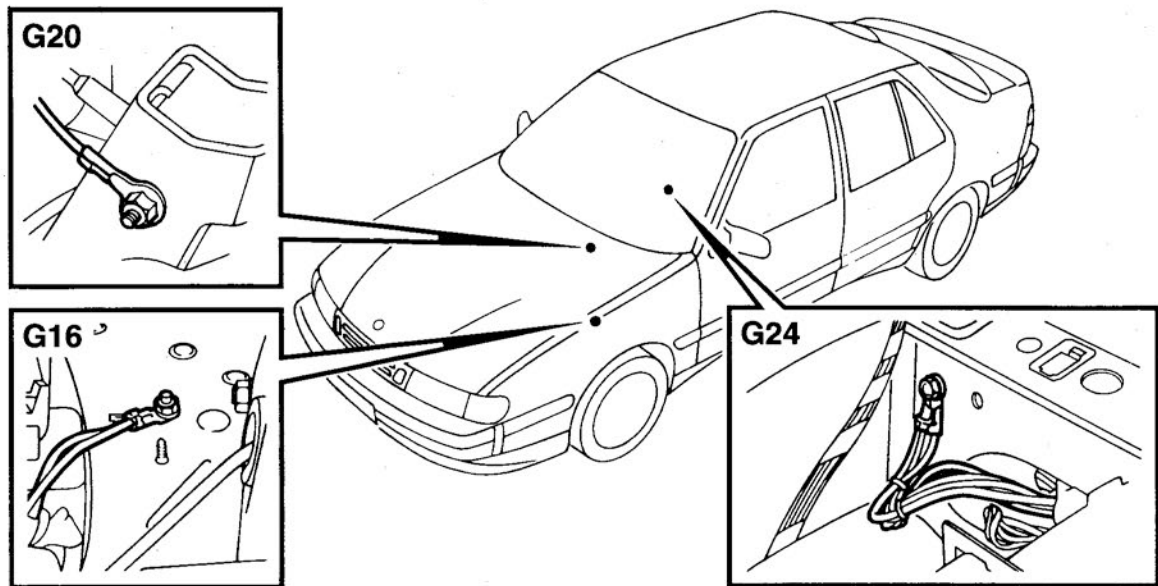

C371W-4588

The following components are connected to grounding point **G16** on the left-hand structural member:

- 294 TC-ABS pressure switch
- 297 Hydraulic pump, TC-ABS
- 299 Brake fluid level sensor, TC-ABS
- 303B Diode ABS, TC-ABS
- 427 Hydraulic pump motor, ABS, ABS-ASR

The following components are connected to grounding point **G20** by the airbag control module:

- 331 Airbag control module

The following components are connected to grounding point **G24** on the right-hand front seat member:

- 64 Heating pad
- 71 Seat-belt switch, right-hand
- 208 Door indication, right-hand rear door
- 224 Lighting, seat-belt buckle
- 248 Fan, right-hand rear door
- 255 Temperature sensor, right-hand
- 348 Data link connector, diagnostic
- 351 Amplifier
- 354 Amplifier
- 358 Switch, electrically adjustable seat, right-hand
- 358K Control module, electrically adjustable seat with memory, right-hand
- 369 Microswitch, backrest, electrically adjustable seat, right-hand
- 416 Relay, EXH warning
- 439 Solenoid, selector lever
- 440 Microswitch, selector lever
- 446 Relay, electrically adjustable seat (ignition switch), right-hand
- 447 Relay, electrically adjustable seat (door switch), right-hand

Grounding points G3, G4, G27

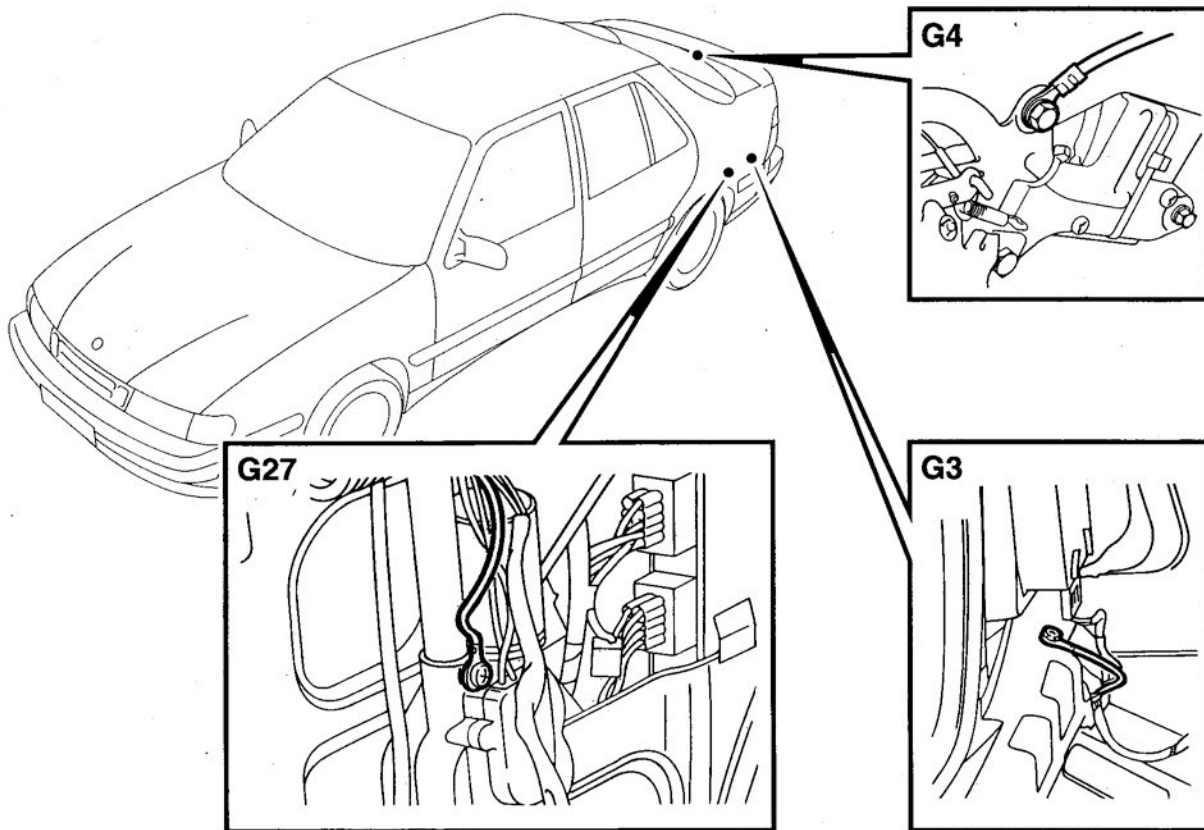

The following components are connected to grounding point **G3** via a 3-pin connector in the luggage compartment (5-D) beside the left-hand rear light cluster and an 8 pin connector by the left-hand rear wheel housing:

- 15 Number plate lighting
- 56 Luggage compartment light switch
- 188 Motor, luggage compartment lock
- 258 Pre-installed trailer wiring

Left-hand rear light cluster:

- 14 Rear lights
- 27 Direction indicator lamp, rear left-hand
- 30 Brake lights
- 32 Reversing lights
- 33 Rear fog light

The following components are connected to grounding point **G4** on the CS tailgate:

- 115 Electrically heated rear window CS

The following components are connected to grounding point **G27** beside the motorized aerial:

- 265 Motorized aerial

Grounding points G26, G29

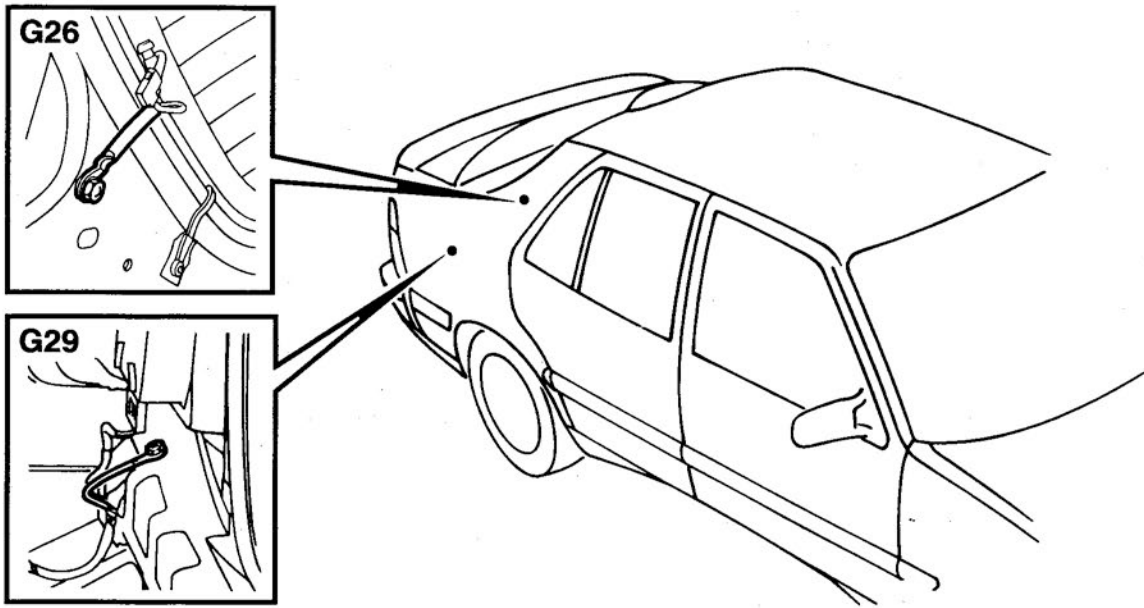

C371W-4590

The following components are connected to grounding point **G26** on the right-hand C pillar:

115 Electrically heated rear window CD

The following components are connected to grounding point **G29** beside the right-hand rear light cluster:

14	Rear lights
28	Direction indicator lamp, right-hand rear
30	Brake lights
32	Reversing lights

Grounding points G30, G31

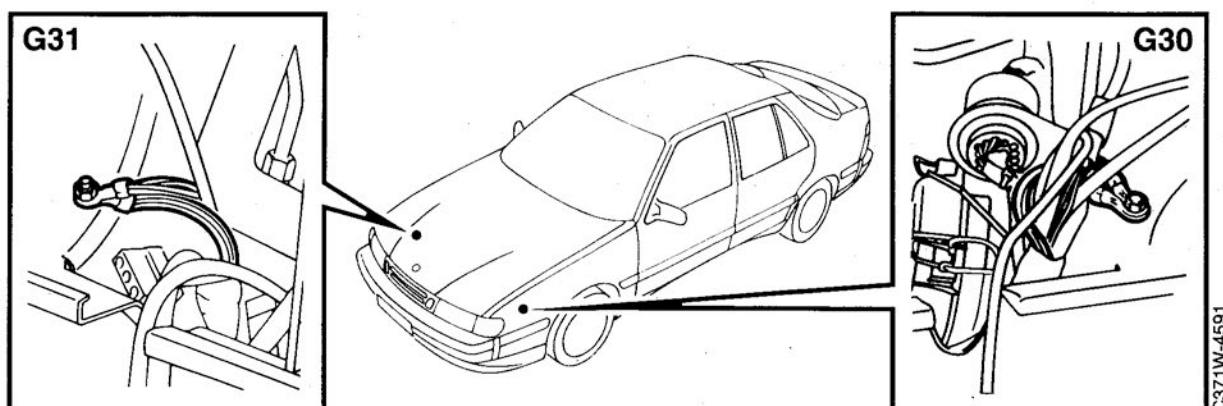

C371W-4591

Grounding point **G31** is located on the right-hand structural member behind the right-hand headlamp. The following components are connected to the grounding point:

- 11 Full beam, right-hand
- 12 Dipped beam, right-hand
- 13 Parking light, right-hand
- 28 Direction indicator lamp, front right-hand
- 63 Washer motor, rear
- 66 Headlamp wiper motor, right-hand
- 85 Extra fog light, right-hand
- 118 Corner light, right-hand
- 119 Side reversing lights, right-hand
- 166 Pressure switch, AC fan
- 195 Washer fluid level switch
- 234 Side marker lights, right-hand
- 242 Coolant level switch, EDU
- 281 Headlamp beam adjustment motor, right-hand
- 370 Thermostatic switch, 1-speed radiator fan
- 371 2-position thermostatic switch, 2-speed radiator fan
- 419 Pressure switch, A/C system, ME

Grounding point **G30** is located on the left-hand structural member behind the left-hand headlamp. The following components are connected to the grounding point:

- 8 Lighting relay
- 11 Full beam, left-hand
- 12 Dipped beam, left-hand
- 13 Parking light, left-hand
- 27 Direction indicator, front left-hand
- 37 Motor, radiator fan
- 40 Horn
- 66 Motor, headlamp wiper, left-hand
- 78 Relay, dimmed dipped beam (CS)
- 85 Extra fog light, left-hand
- 107 Extra fog lights relay
- 118 Corner light, left-hand
- 119 Side reversing lights, left-hand
- 172 Radiator fan, A/C
- 228B Filament monitor, engine bay
- 234 Side marker light, left-hand
- 276 Bonnet switch, anti-theft alarm
- 280 Headlight beam adjustment motor, left-hand
- 325 Secondary air injection control valve
- 326 Secondary air injection pump
- 366 Motor, two-speed radiator fan
- 433 Relay, disengagement of A/C radiator fan

Control module locations

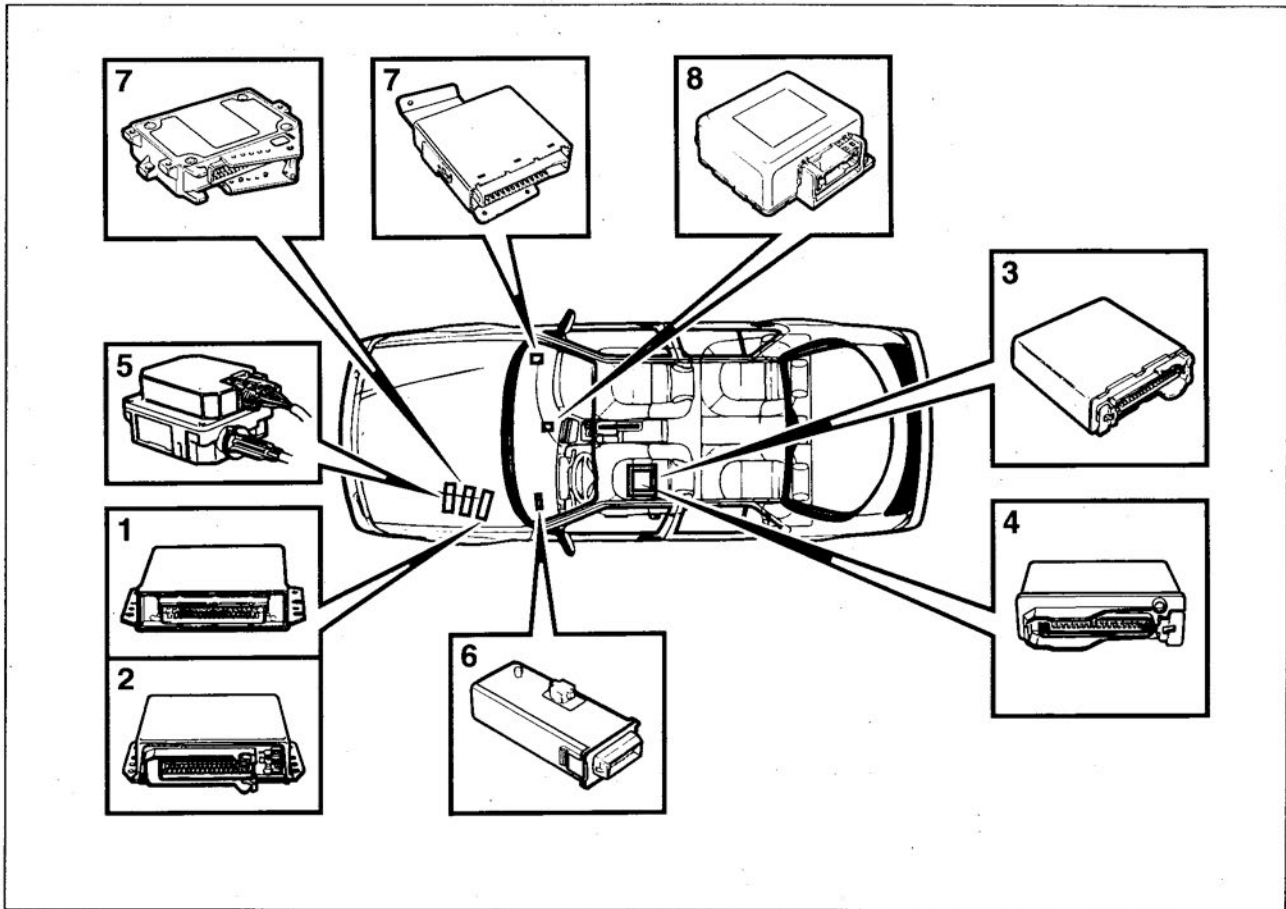

Engine systems

1. Saab Trionic
2. Motronic

The control modules are located on a bracket in the bulkhead partition space. The bracket is mounted on the front upper left-hand side of the bulkhead plate.

3. ETS
4. TTS

The control modules are located on a bracket under the left-hand front seat.

Comfort systems

5. Cruise Control system

The Cruise Control system control module is mounted beside the battery tray.

6. Central locking system

The central locking control module is mounted on a bracket at the far left under the dashboard.

Safety systems

7. ABS or TC/ABS

The ABS or TC/ABS control module is mounted on the battery tray.

8. SRS (airbag)

The SRS control module is located on a bracket in the front part of the centre console inside the cabin under the dashboard.

9. Anti-theft alarm

The anti-theft alarm control module is located inside the cabin behind the glove box and knee shield on the right-hand side behind the dashboard.

Power supply (+30 circuit)

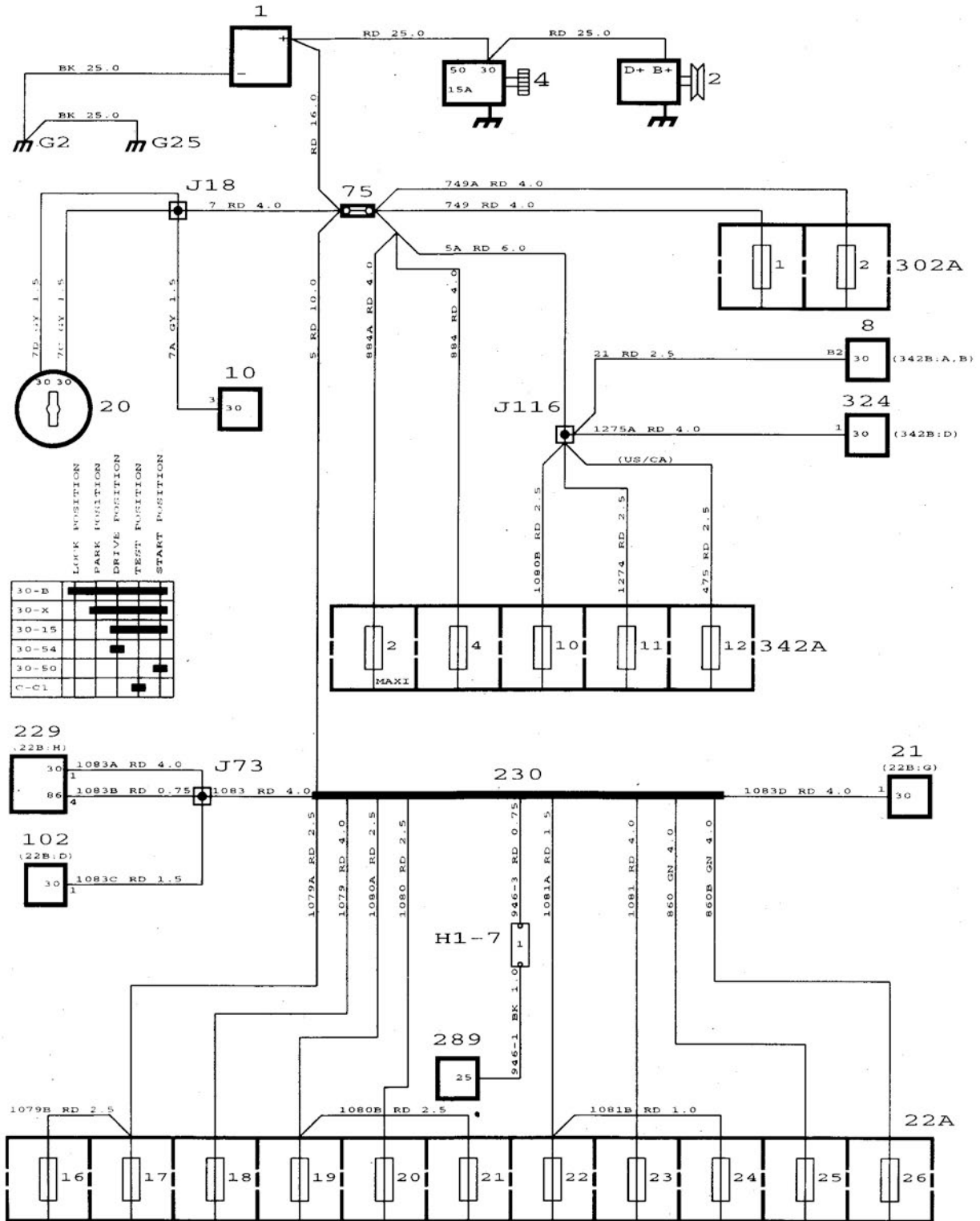

Description of operation

Positive voltage is taken directly from battery 1 to the following components:

- Starter motor 4 and on to generator 2
- Distribution block 75
- Ignition switch 20
- Light switch 10
- Distribution terminal 230 (+30)

From distribution terminal 230 on to:

- Fuses 16-26 in main fuse box 22A behind the glove box
- Ignition switch relay 21
- Main relay 229 for fuel injection
- Fuel pump relay 102
- Control module, anti-theft alarm 289

After distribution block 75, current continues to the following components:

- Lighting relay 8
- Relay, secondary air injection pump 324
- Main fuse box 302A in the engine bay, fuses 1 and 2
- Main fuse box 342A in the engine bay, fuses 2 (maxi), 4 and 10-12

Fault diagnosis hints

- 1 Check the battery voltage.
- 2 Check the connections on distribution block 75 and terminal block 230.
- 3 Check that current is supplied to each component.
- 4 Check the relevant wiring harness.

Power supply (+15 circuit)

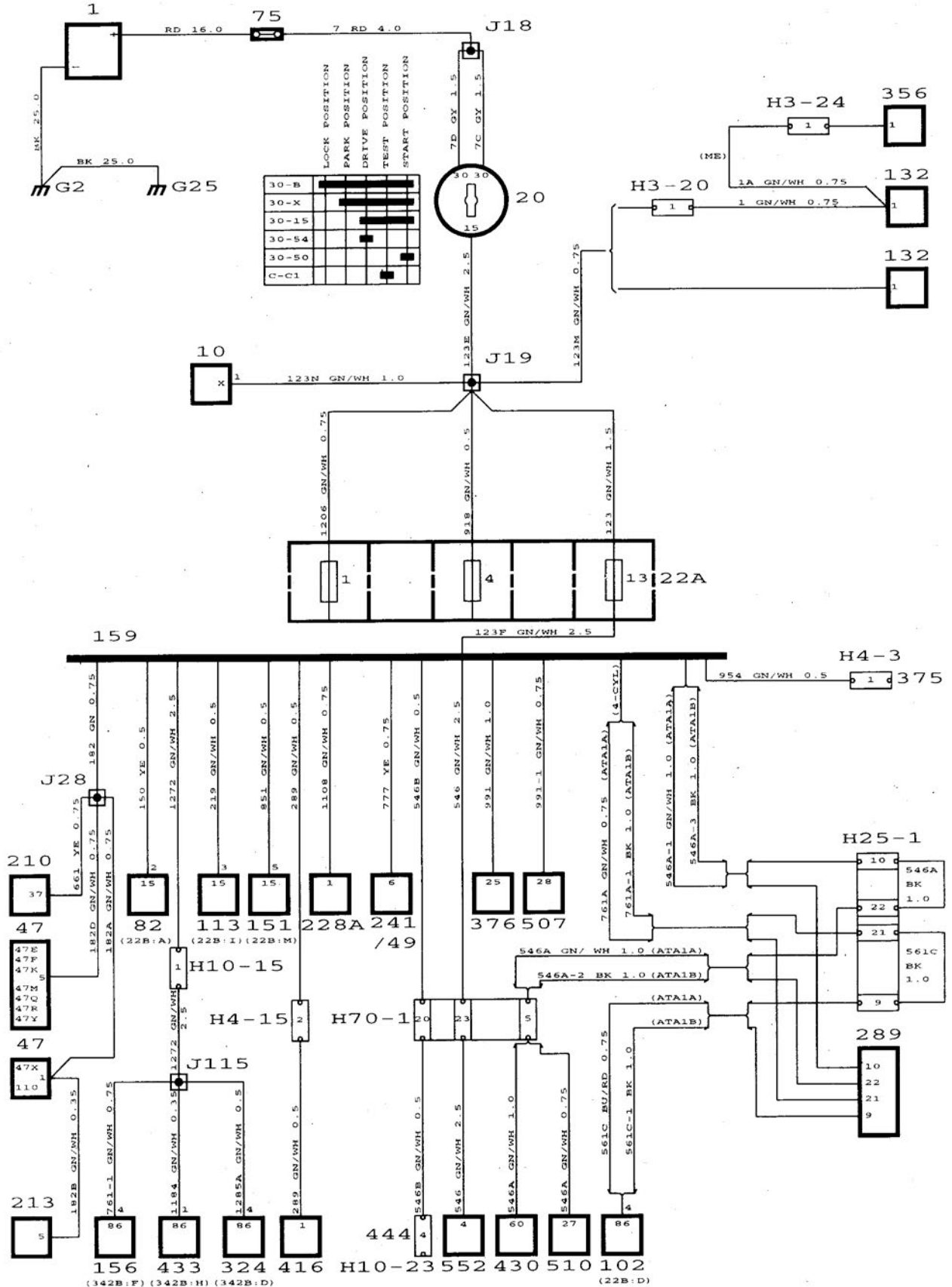

	LOCK POSITION	
30-B	<input checked="" type="checkbox"/>	
30-X	<input checked="" type="checkbox"/>	
30-15	<input checked="" type="checkbox"/>	
30-54	<input checked="" type="checkbox"/>	
30-50	<input checked="" type="checkbox"/>	
C-C1	<input checked="" type="checkbox"/>	

Description of operation

From battery 1, positive voltage is fed to ignition switch 20. When the ignition switch is in the Drive or Start position, current flows from ignition switch connection 15 to:

- Lights switch 10
- Speed sensor 132.
- Speed warning control module 356
- Main fuse box 22A fuses 1, 4 and 13.

Current is supplied from fuse 13 to distribution terminal 159 where the following components are connected:

- Main instrument display panel 47
- Clock 49
- Relay for seat-belt/ ignition key warning 82
- Relay for fuel pump 102
- Relay for electrically heated rear window 113
- Time-delay relay for interior lighting 151
- Relay for A/C compressor and radiator fan 156
- EDU trip computer 210
- Pictogram 213
- Filament monitor 228A
- SCC trip computer 241
- Anti-theft alarm control module 289
- Relay for secondary air injection pump 324
- Connection for mobile telephone relay 375
- ETS control module 376
- Relay for EXH warning 416
- Saab Trionic control module 430
- Relay for disengagement of radiator fan 433
- Saab Trionic data link connector (for production only) 444
- TTS control module 507
- Motronic 2.8.1 control module 510
- Ignition coil unit V6 552

Fault diagnosis hints

- 1 Check the battery voltage.
- 2 Check the connections on distribution block 75 and terminal block +15 (159).
- 3 Turn the ignition switch to the Drive position and check that current flows through fuses 9 and 13.
- 4 Check the relevant wiring harness.

Power supply (+54 circuit)

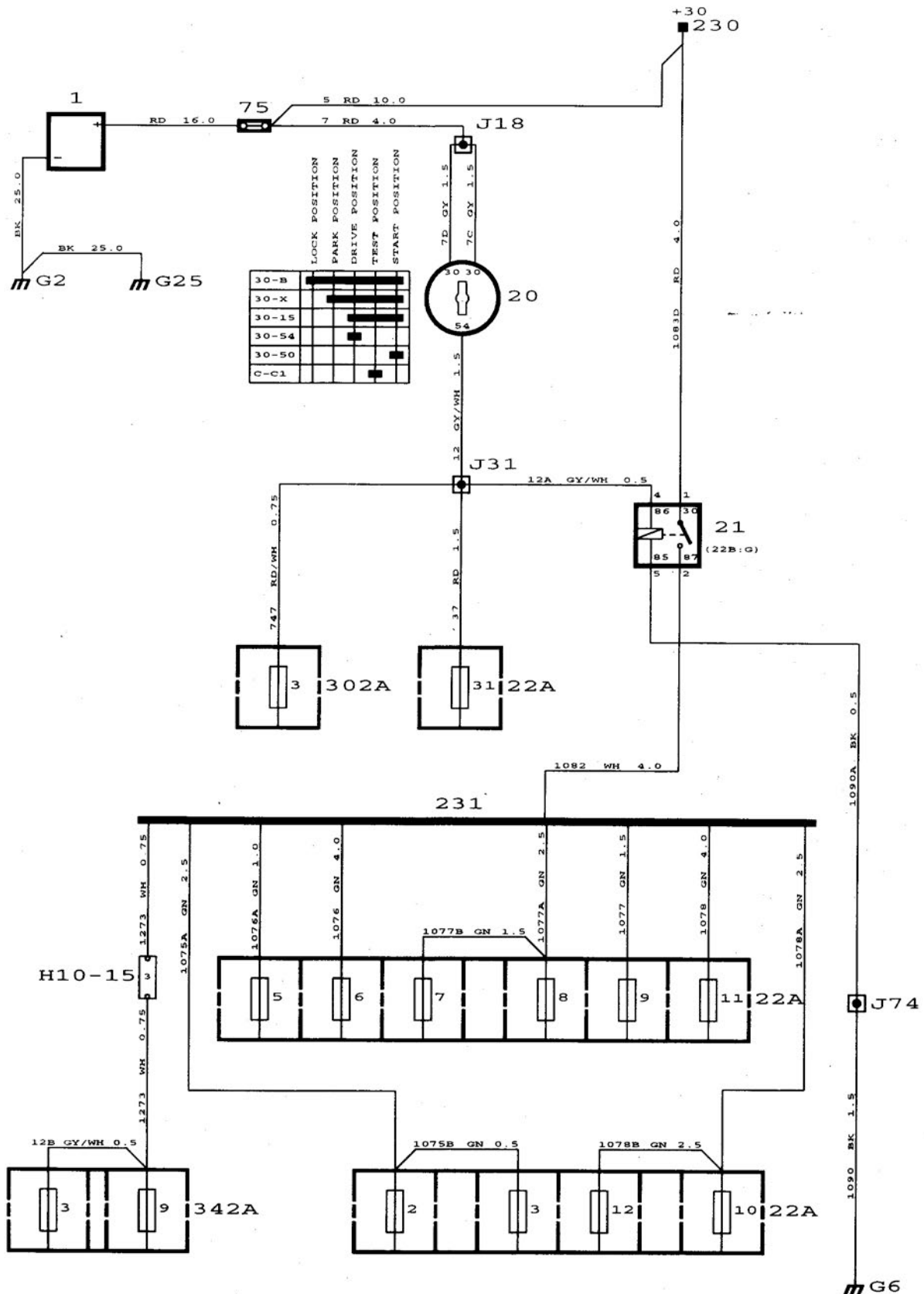

Description of operation

From battery 1, positive voltage is fed via distribution block 75 to:

- Terminal block 230 (+30) and on to connection 30 on ignition switch relay 21.
- Connection 30 on ignition switch 20.

When the ignition switch is turned to the Drive position, terminals 30 and 54 on the ignition switch are connected to each other. Current is then supplied to:

- Fuse 3 in main fuse box 302A (ABS)
- Fuse 31 in main fuse box 22A
- Ignition switch relay 21

The relay contact in ignition switch 21 closes and current is supplied via terminal block 231 (+54) to:

- Fuses 2, 3 and 5-12 in main fuse box 22A behind the glove box.
- Fuses 3 and 9 in main fuse box 342A in the engine bay.

Fault diagnosis hints

- 1 Check the battery voltage.
- 2 Check the connections on distribution block 75 and the +30 (230) and +54 (231) terminal blocks.
- 3 If current is present on the +30 terminal but not on the +54 terminal, check that ignition switch relay 21 is working by turning the ignition switch to the Drive position. Current should then be present on relay connection 87.
- 4 Check the relevant wiring harness.

Power supply (+X circuit)

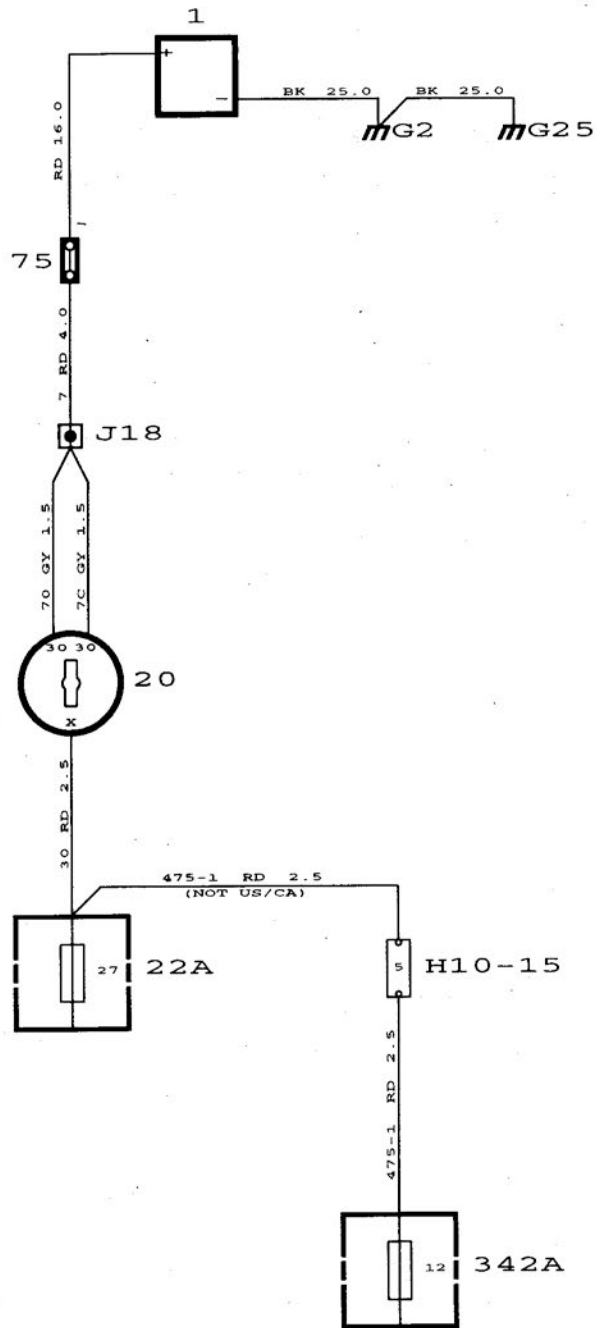

Description of operation

Positive voltage is fed from battery 1 via distribution block 75 to terminal 30 on ignition switch 20. When the ignition switch is in any position except OFF, terminals 30 and X are connected to each other. Current is then supplied to:

- Fuse 27 in main fuse box 22A behind the glove box.
- Fuse 12 in main fuse box 342A in the engine bay.

Fault diagnosis hints

- 1 Check the battery voltage.
- 2 Check the connections on distribution block 75.
- 3 Check that current is present on connections 30 and X on ignition switch 20.
- 4 Check the relevant wiring harness.

Starting and charging systems

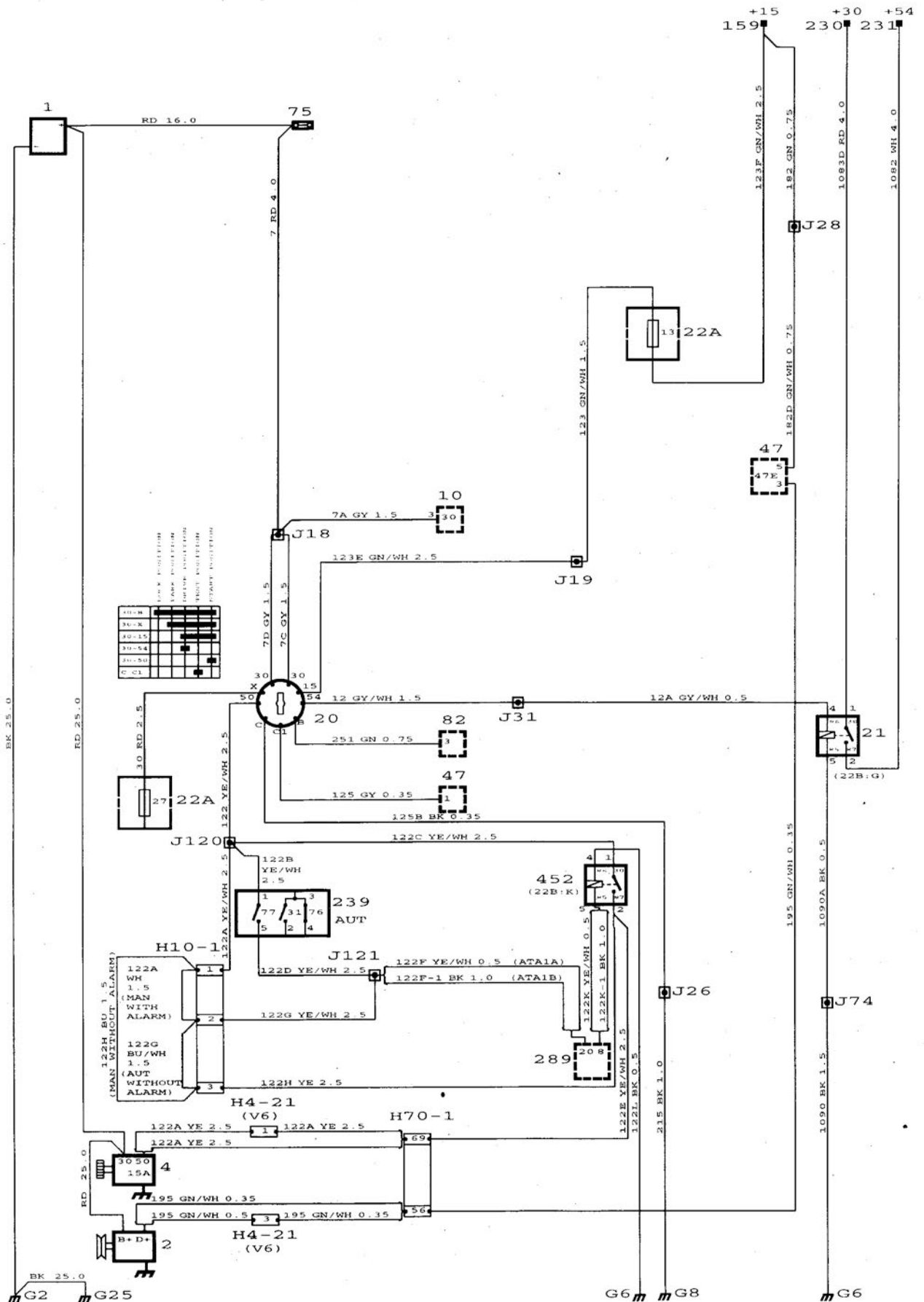

ATA1A = US/CA
ATA1B = SE/EU/GB/ME/PA/LA/AU

Description of operation

Starting system

Current (+30 circuit) is supplied from battery 1 to ignition switch 20 and also direct to connection 30 on starter motor 4.

When the ignition switch is turned to the Start position, current (+50 circuit) is supplied to the actuating coil of the solenoid. The actuating coil closes the start contact, allowing current from the battery to flow through the starter motor which then starts to rotate.

In certain markets, current (+50 circuit) is supplied to the anti-theft alarm control module (289) and starter interlock relay 452.

Automatic transmission

On cars with automatic transmission, starter motor interlock 77 is fitted to prevent the engine from being started when the selector lever is in position 1, 2, 3, D or R.

Charging system

The charging warning lamp informs the driver whether the generator is charging the battery or not. When ignition switch 20 is in the Drive position, positive voltage (+15 circuit) is supplied via fuse 13 to charging warning lamp 47E in the main instrument display panel and then on to generator 2.

When the generator is not rotating or if it is not charging for some reason or other, the charging warning lamp circuit is grounded through the generator and the lamp will light up.

When the generator is charging, connection D+ receives the same voltage as B+. The charging lamp is then supplied with the same voltage on both connections and the lamp goes out.

Important:

Since the field excitation of the generator is built up through the incandescent bulb, the bulb rating (2W) must not be changed.

To increase the field excitation still further, a resistor is connected in parallel with the bulb.

A diode is connected in series with the charging lamp to prevent reverse currents.

Fault diagnosis hints

Starting system

- 1 Check the battery positive voltage on starter motor 4, connection 30.
- 2 Check the operating voltage on the starter motor solenoid with the ignition switch in the Start position.
- 3 Check the terminal blocks and wiring harness.
- 4 Check that the engine is grounded to the car chassis.

Charging system

- 1 Check the battery voltage on alternator 2.
- 2 Check that fuse 13 is intact and live.
- 3 Check that the charging lamp bulb is intact.
- 4 Check connectors and the wiring harness as well as the generator's ground connection.
- 5 Check that terminal D+ on the alternator is live.
- 6 Start the engine and take a voltage reading between B+ on the generator and ground. Also take a voltage reading between D+ on the generator and ground. The difference between the two readings should not be more than 0.7 V.

Component locations

1	Battery in engine bay.		<i>3-pin connector</i>
2	Generator at the rear of the engine on the right-hand side.	H3-20	Behind the main instrument display panel beside the speedometer (ME).
4	Starter motor on the left-hand side of the engine at the rear.		<i>4-pin connector</i>
10	Lights switch on dashboard between steering wheel and driver's door.	H4-21	Beside the generator (V6).
20	Ignition switch to the right of the steering column.	H10-1	<i>10-pin connector</i> Under the dashboard to the left of the heater housing.
21	Ignition switch relay in main fuse box behind the glove box.		<i>70-pin connector</i>
22A	Fuse holder behind the panel in the glove box/under the passenger airbag.	H70-1	In the engine bay, behind the bulkhead partition.
47	Main instrument display panel in the dashboard.	G2	Grounding point, battery tray, on the left-hand wheel housing.
47E	Charging indicator lamp in the main instrument display panel.	G6	Grounding point, negative distribution terminal, in main fuse box behind the glove box.
75	Distribution block, battery positive, on the battery tray.	G8	Grounding point, dashboard, beside the left-hand loudspeaker socket.
77	Starter interlock contacts (automatic transmission) in transmission range switch 239 beside the selector lever.	G25	Gearbox grounding point.
82	Relay, seat-belt and ignition key warning, in main fuse box behind the glove box.		
159	Distribution terminal (+15 circuit) in main fuse box behind the glove box.		
230	Distribution terminal (+30 circuit) in main fuse box behind the glove box.		
231	Distribution terminal (+54 circuit) in main fuse box behind the glove box.		
239	Transmission range switch beside the selector lever.		
289	Anti-theft alarm control module on the right-hand side under the dashboard, behind the knee shield.		
452	Starter relay, anti-theft alarm in main fuse box behind the glove box.		

Components

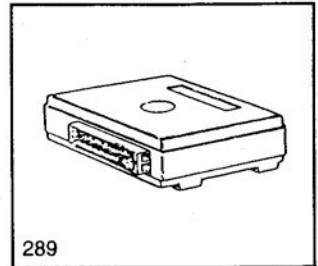
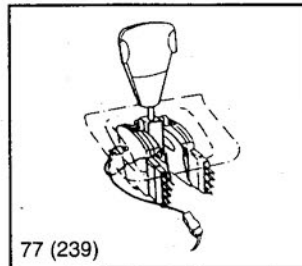
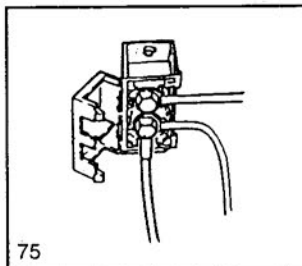
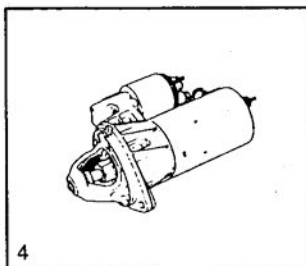
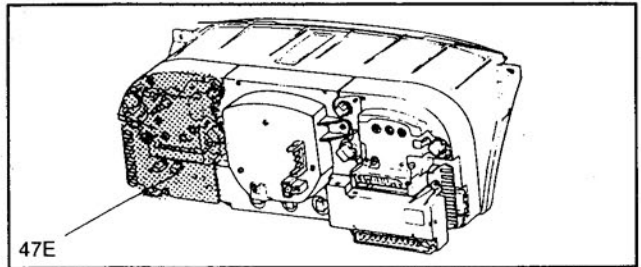
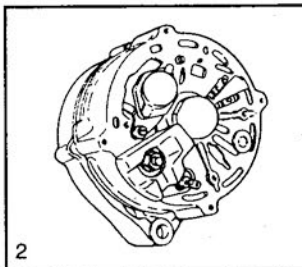
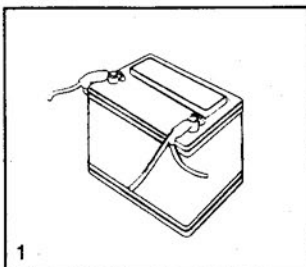
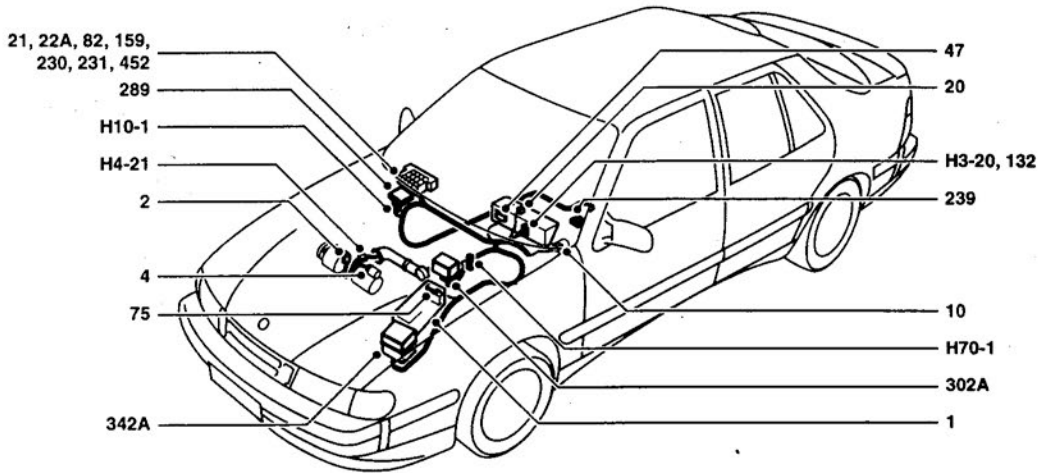

C331W-4509

Cooling system

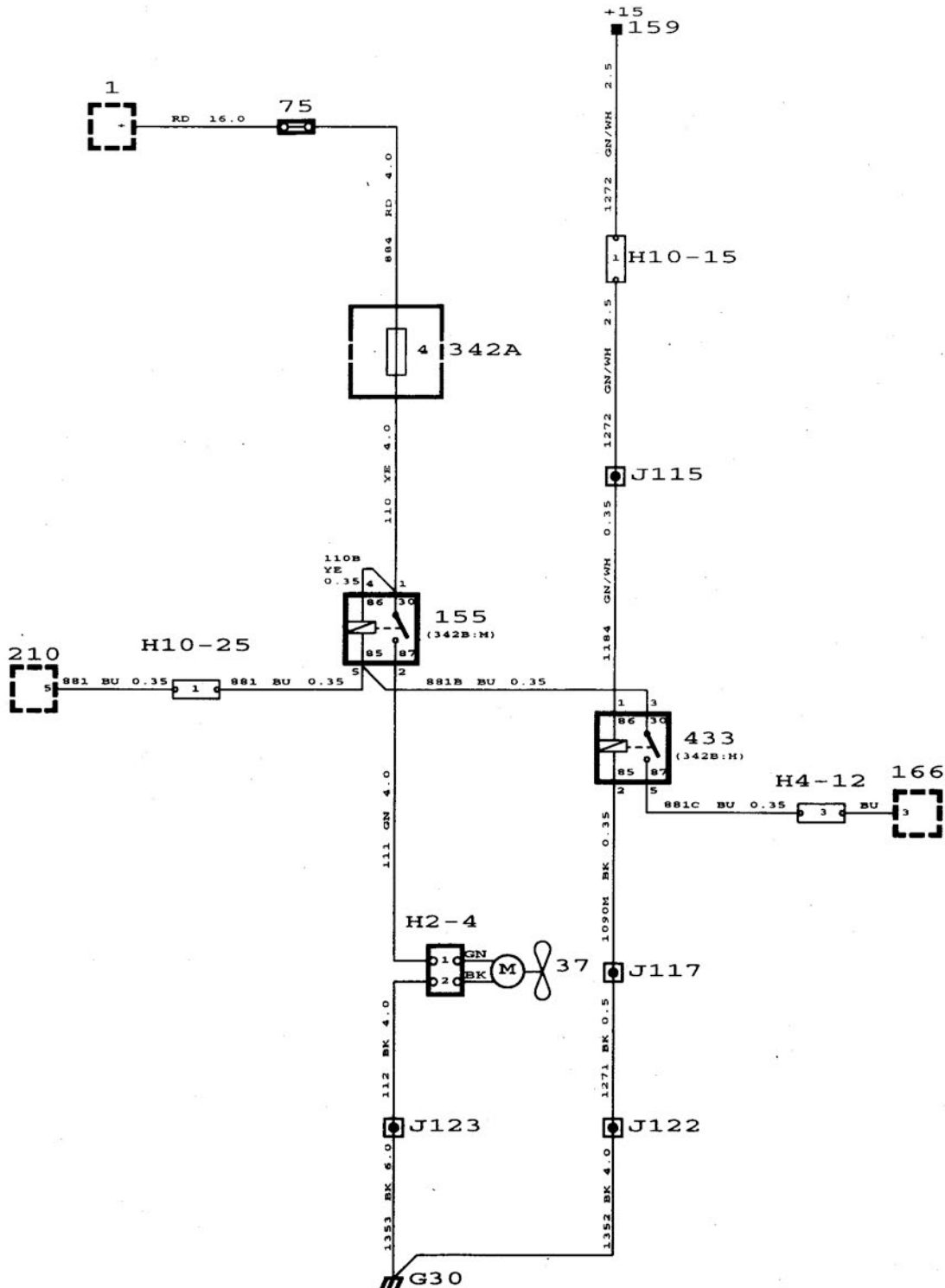

Cooling system with 2-speed radiator fan

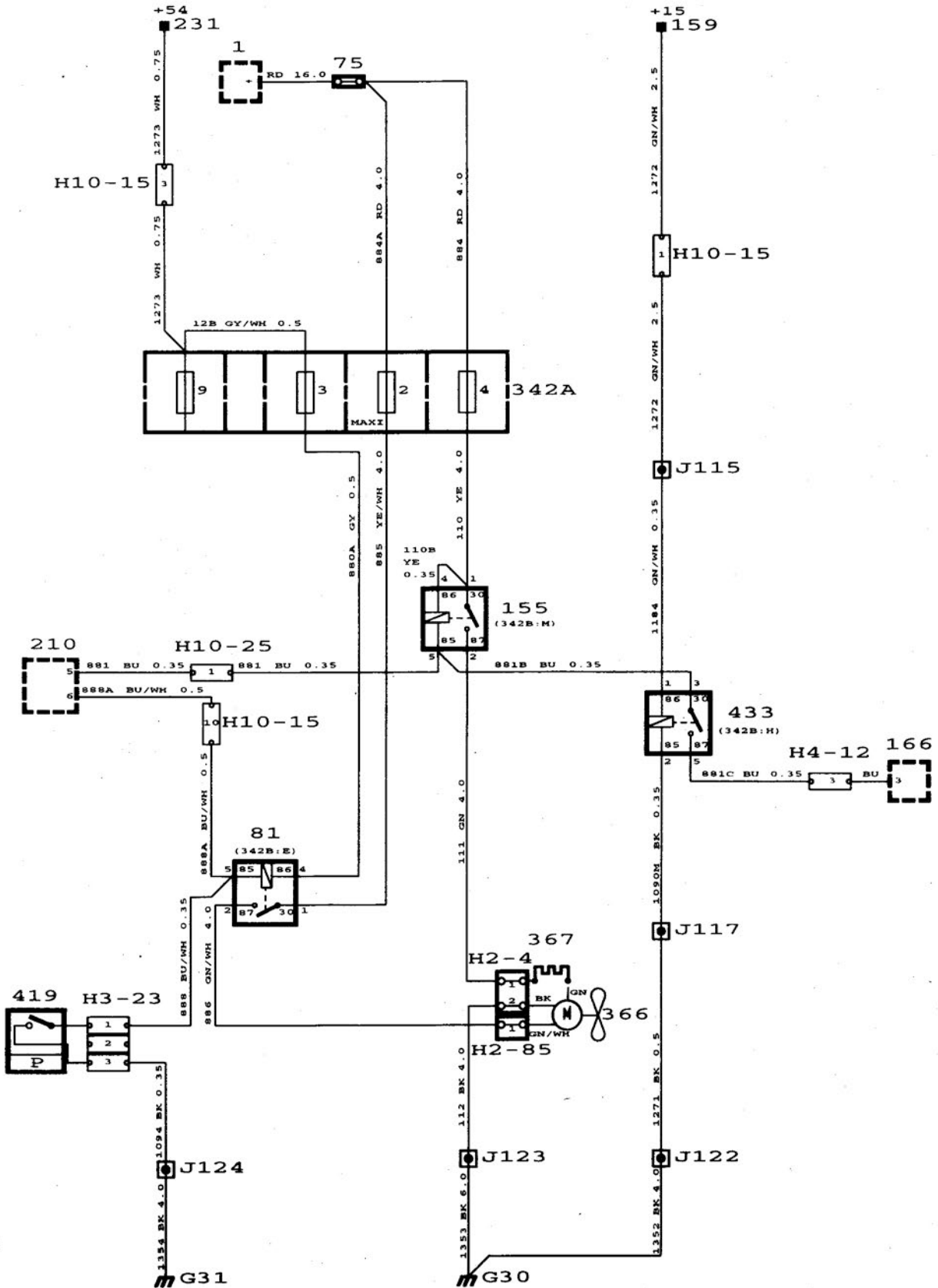

Description of operation

The cooling fans are controlled from the EDU control module.

Irrespective of the position of the ignition switch, power is supplied to relay 155 via fuse 4.

The engine coolant temperature is measured by the EDU control module, which controls relay 155.

Single-speed radiator fan 37

When coolant temperature reaches about 100°C (212°F), relay 155 operates and radiator fan 37 starts. When the temperature drops to about 96°C (205°F), the fan stops.

2-speed radiator fan 366

Some cars are fitted with a 2-speed radiator fan which gives efficient cooling.

Speed 1 works as above.

When the coolant temperature reaches 111 °C (232 °F), relay 81 is grounded via the EDU control module. The radiator fan then runs at full speed. When the coolant temperature drops to 107 °C (225 °F), the fan reverts to speed 1.

Relay, disengagement of radiator fan 433

To prevent the battery from being drained when the radiator fan continues to run after the engine has been switched off, relay 433 breaks the circuit as soon as the ignition is switched off. However, the EDU control module can cause relay 155 to operate so that the fan will continue to run at speed 1, but then only for 3.5 minutes.

Extra pressure switch 419

In certain markets, the A/C system is equipped with an extra pressure switch which controls relay 81. If the refrigerant pressure exceeds 22 bar, the contact is closed. This activates relay 81 and engages speed 2 on radiator fan 366.

Fault diagnosis hints

1-speed radiator fan

- 1 Check that fuse 4 is intact and live.
- 2 Check that current is supplied to relay 155.
- 3 Check that the relay operates and that the radiator fan is working.
- 4 Run the engine until it reaches operating temperature and check that the EDU control module is in working order.
- 5 Check connectors and the wiring harness as well as ground connections.

2-speed radiator fan

- 1 Check that fuse 4 is intact and live.
- 2 Inspect maxi fuse 2.
- 3 Check fuse 3.
- 4 Check that current is supplied to relay 155.
- 5 Check that the relay operates and that resistor 367 is OK.
- 6 Run the engine until it reaches operating temperature and check that the EDU control module is in working order.
- 7 Check connectors and the wiring harness as well as ground connections.

Component locations

1	Battery in the engine bay.
37	Radiator fan motor on left-hand side of radiator.
75	Distribution block, battery, on the battery tray.
81	2-speed radiator fan relay, in main fuse box in front of battery.
155	Radiator fan relay, in main fuse box in front of battery.
159	Distribution terminal (+15 circuit) in main fuse box behind the glove box.
166	Pressure switch for the radiator fan, on the receiver in front of the right-hand wheel housing.
210	EDU. In main instrument display panel.
231	Distribution terminal (+54 circuit) in main fuse box behind the glove box.
342 A	Fuse board in main fuse box in front of battery.
366	Motor, 2-speed radiator fan, on left-hand side of radiator.
367	Resistor beside the radiator fan motor.
419	A/C cooling pressure switch (ME), under the radiator on the right-hand side.
433	Relay for disengagement of radiator fan, in main fuse box in front of battery.
	<i>2-pin connectors</i>
H2-4	Adjacent to the radiator fan motor.
H2-85	Adjacent to the radiator fan motor.
	<i>3-pin connector</i>
H3-23	Under the front bumper behind the right-hand fog light.
	<i>4-pin connector</i>
H4-12	Beside the right-hand wheel housing adjacent to the receiver.
	<i>10-pin connectors</i>
H10-15	Behind the left-hand headlamp.
H10-25	Behind the left-hand headlamp.
G30	Grounding point on the left-hand structural member, behind the left-hand headlamp.
G31	Grounding point on the right-hand structural member, behind the right-hand headlamp.

Components

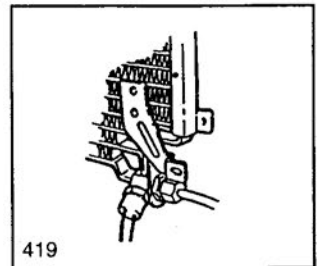
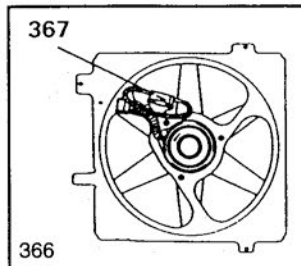
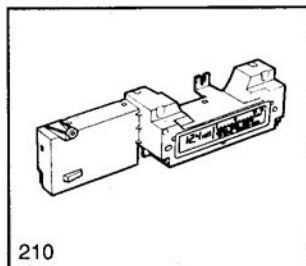
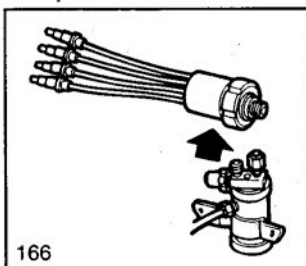
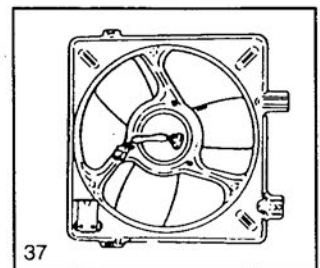
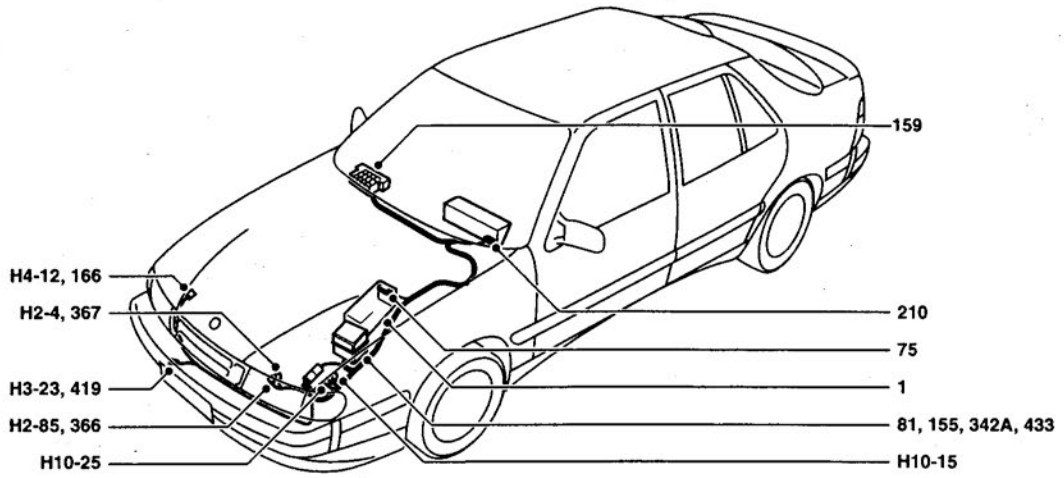

C261W-4511

Traction Control System (TCS) for manual gearbox

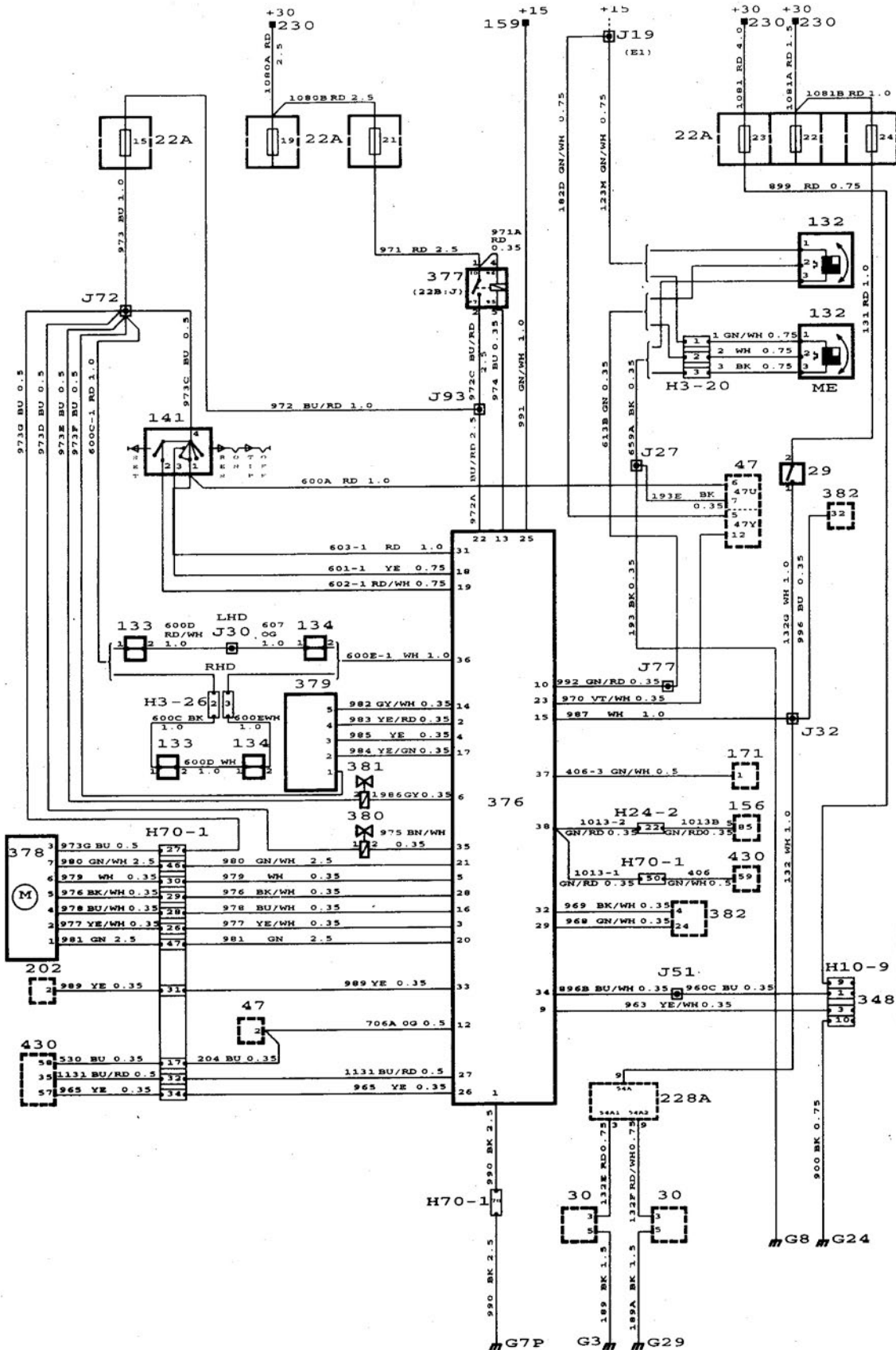

Description of operation

The main function of the TCS system is to regulate and control the position of the throttle butterfly valve in the throttle body. As it does this electronically, it is called the Electronic Throttle System, ETS.

Apart from control module 376, the system consists of a comparatively small number of components.

Throttle body 378 is equipped with a motor for regulating the throttle butterfly valve, a vacuum unit, a throttle position sensor and a safety cut-out.

Mounted on the accelerator pedal is pedal position sensor 379 with a potentiometer which senses the current position of the accelerator pedal.

As a safety feature, there is also a parallel system with a throttle cable which is activated when driving in limp-home mode.

Data concerning vehicle speed is received by the control module from two different sources: from speed sensor 132 at the rear of the instrument and from TC-ABS electronic control module 382 (average of the two front wheels). By comparing these signals and indicating faults when there is any deviation, we can check that both systems are working and in this way achieve a high degree of safety.

Data concerning engine speed is received by the ETS throttle control module from Trionic control module 430, which in its turn receives data on engine speed from the crankshaft position sensor on the belt pulley.

This information is used, among other things, for temperature-dependent engine speed control which the system uses after starting.

The engine load signal (Tq) from Trionic control module 430 is a measure of the intake mass air flow. This information is used by the ETS system when driving with the Cruise Control on, and to detect when fuel shut-off occurs.

The brake pedal switch is activated as soon as the brake pedal is touched and breaks the Cruise Control connection (breaking contact).

An NTC resistor (202) is used to provide data about the engine temperature (coolant temperature). This data is used, among other things, to regulate the increase in engine speed after starting from cold.

The function of boost pressure control valve 381 is to disconnect the turbo charge air bypass valve when the car is driven with the Cruise Control system engaged or during antispin control. This prevents the charge air bypass valve fluctuating between the open and closed positions and causing variations in boost pressure and speed.

Operating current for main relay 377 is grounded via control module pin 13, which activates the relay and supplies the system with current (+30 circuit). When safety-related faults arise in the system, the grounding connection on pin 13 is broken, deactivating the relay and breaking the supply of current via the +30 circuit. When this happens, the current supplied to safety valve 380 on the bulkhead partition is also cut off, causing the valve to close the vacuum hose between the intake manifold and the throttle body's vacuum chamber. When the vacuum in the throttle body disappears, the throttle butterfly valve lever is moved back to the closed throttle position and the throttle cable is tensioned. In other words, the limp-home mode is engaged.

The ETS system communicates with the ISAT scan tool via data link connector 348.

Communication is in the form of a pulse train and enables the system to be cleared of any incorrect data in the system. It also enables command codes to be sent for activation of certain system functions, clearing of the system's DTC memory, etc.

When a fault occurs in the ETS system which affects the performance of the system, the lamp circuit is grounded via pin 23 of the control module and warning lamp 47Y lights up.

To find out what fault has caused the warning lamp to light up, the ISAT scan tool must be connected to the data link connector and scan tool diagnostics undertaken.

Fault diagnosis hints

- Check that fuse 21 is intact and live.
- All fault diagnosis is to be carried out by means of the ISAT scan tool.
- Obtain readouts of all diagnostic trouble codes and make a note of them before disconnecting the battery or the control module.

 **WARNING**

To avoid damaging the control module, check that the ignition is switched off before unplugging the connector.

- Check the connectors, wiring harness and ground connections.

For further fault diagnosis, refer to Service Manual "2:5 Saab Traction Control System (TCS)".

Component locations

22A	Fuse board behind the cover flap in the glove box.	382	TC-ABS control module on battery tray.
29	Brake light switch beside the brake pedal.	430	Saab Trionic control module in engine bay behind the bulkhead partition on the left-hand side.
30	Brake light bulb in rear light cluster.		<i>3-pin connectors</i>
	<i>in the main instrument display panel</i>	H3-20	Behind the main instrument display panel adjacent to the speedometer (ME).
47U	Cruise Control system indicator lamp		(RHD) above the pedal bracket adjacent to the pedal switches.
47Y	TCS CTRL warning lamp	H3-26	<i>24-pin connector</i>
132	Speed sensor in the speedometer in the main instrument display panel.		In the engine bay on the bulkhead partition.
133	Clutch pedal switch, Cruise Control, on the clutch pedal.	H24-2	<i>70-pin connector</i>
134	Brake pedal switch, Cruise Control, on the brake pedal.		In the engine bay, behind the bulkhead partition.
141	Cruise Control selector, on the direction indicator stalk switch on the left-hand side of the steering wheel.	H70-1	
		G3	Grounding point, luggage compartment, beside the left-hand rear light cluster.
156	Relay, A/C radiator fan, in main fuse box in front of the battery.	G7	Grounding point, engine, at the rear of the engine on a sheet metal bracket below the intake manifold.
159	Distribution terminal (+15 circuit) in main fuse box behind the glove box.	G8	Grounding point, dashboard, by the left-hand front loudspeaker socket.
171	Antifrost thermostat on the evaporator casing below the windscreen on the right-hand side.	G24	Grounding point, seat member, right-hand front seat member.
202	Engine temperature sensor on the intake manifold flange between cylinders 1 and 2.	G29	Grounding point, luggage compartment, beside the right-hand rear light cluster.
228A	Filament monitor, rear bulbs, in luggage compartment on the left-hand side.		
230	Distribution terminal (+30 circuit) in main fuse box behind the glove box.		
348 (H10-9)	Scan tool diagnostics data link connector under the right-hand seat.		
376	ETS control module under the left-hand front seat.		
377	Main relay in main fuse box behind the glove box.		
378	Throttle actuator motor, ETS, mounted on intake manifold.		
379	ETS accelerator pedal position sensor beside the accelerator.		
380	ETS dump valve in engine bay on the right-hand side of the bulkhead partition.		
381	ETS bypass valve, in engine bay on left-hand wheel housing adjacent to the battery.		

Components

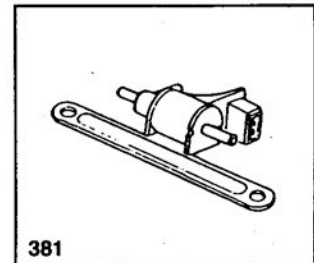
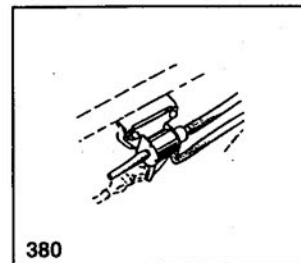
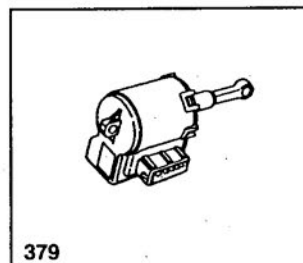
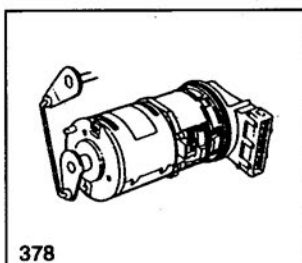
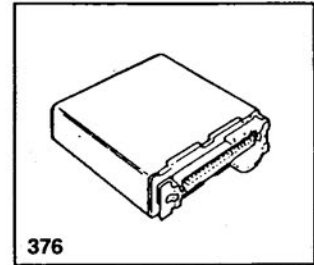
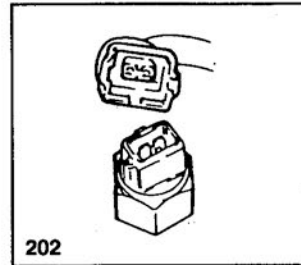
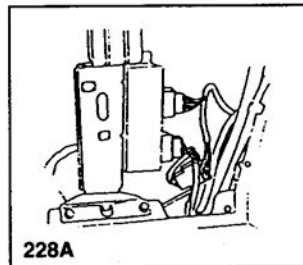
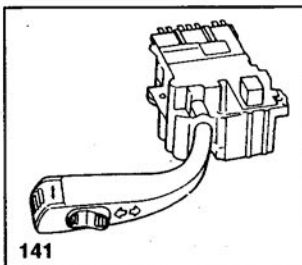
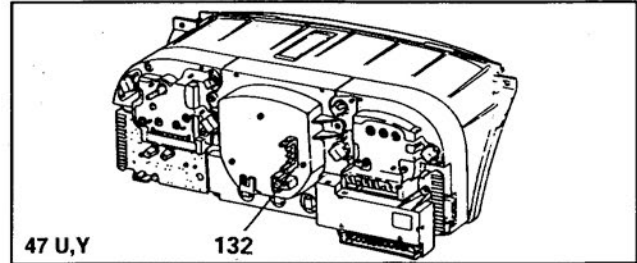
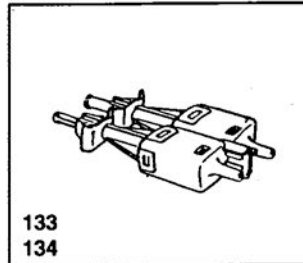
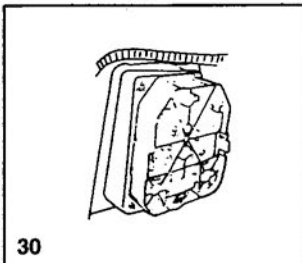
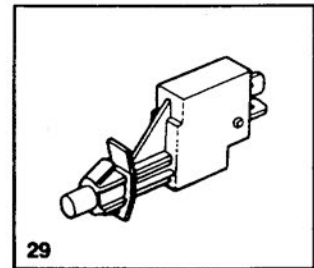
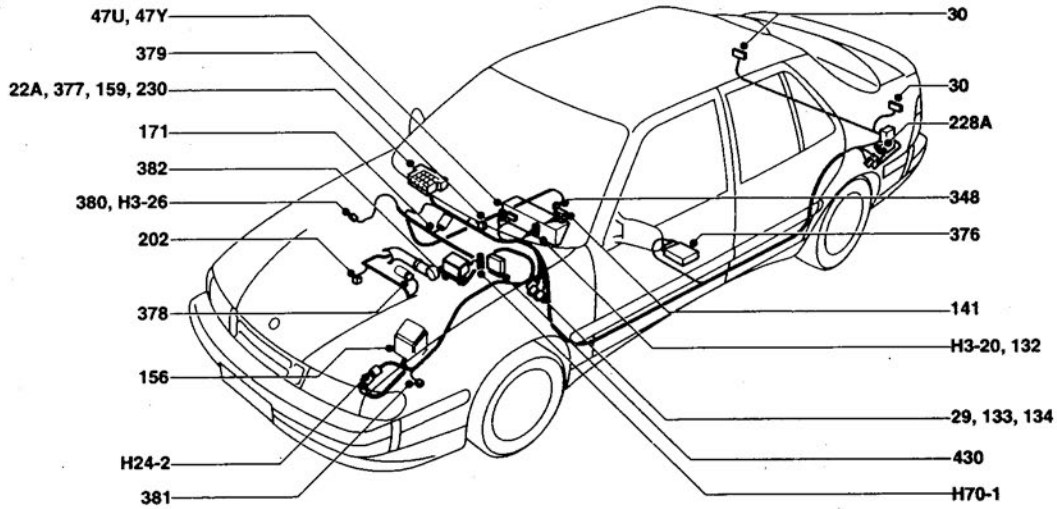

Trionic engine management system

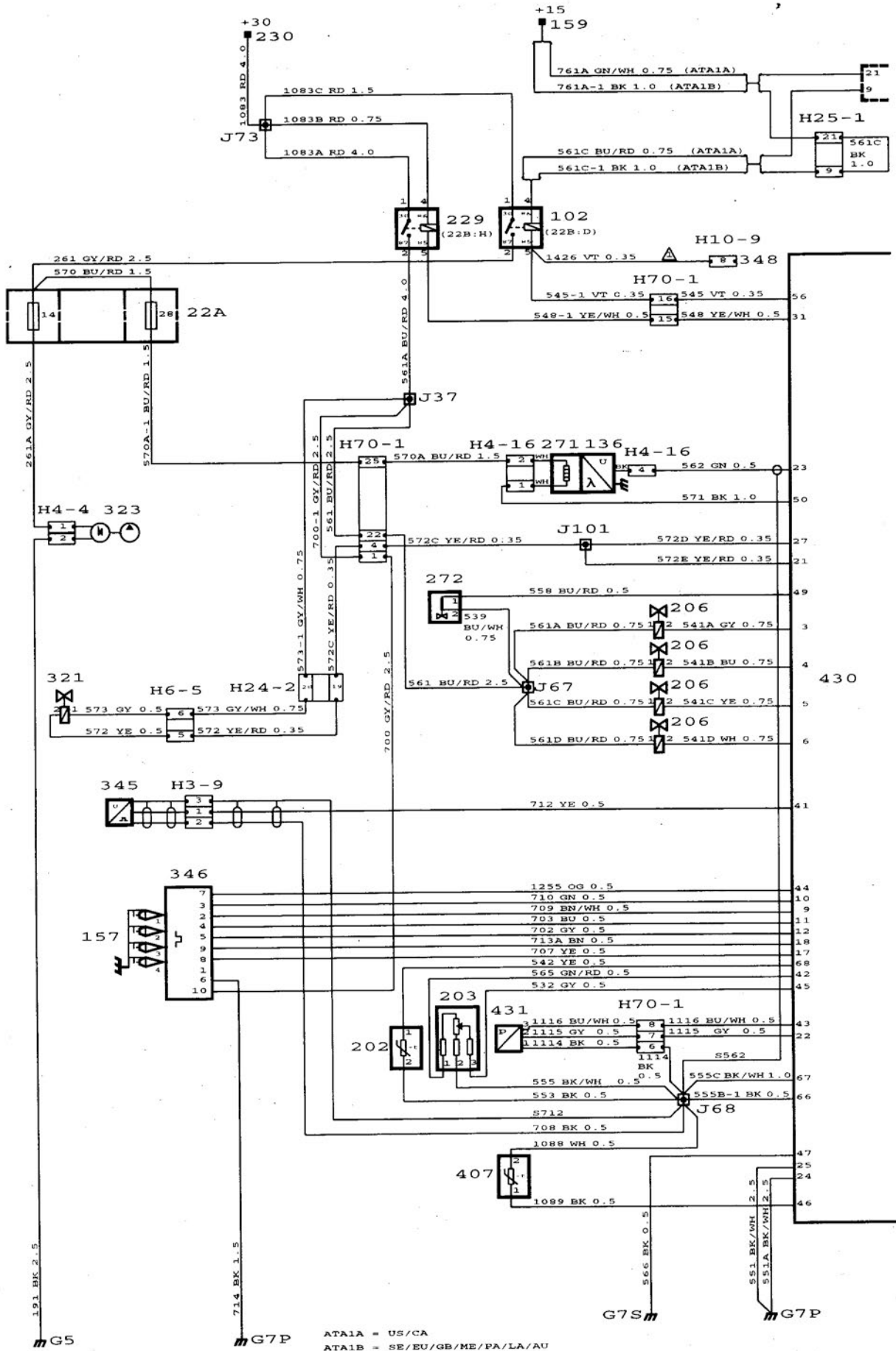

ATA1A = US/CA
ATA1B = SE/EU/GB/ME/PA/LA/AU

Trionic engine management system

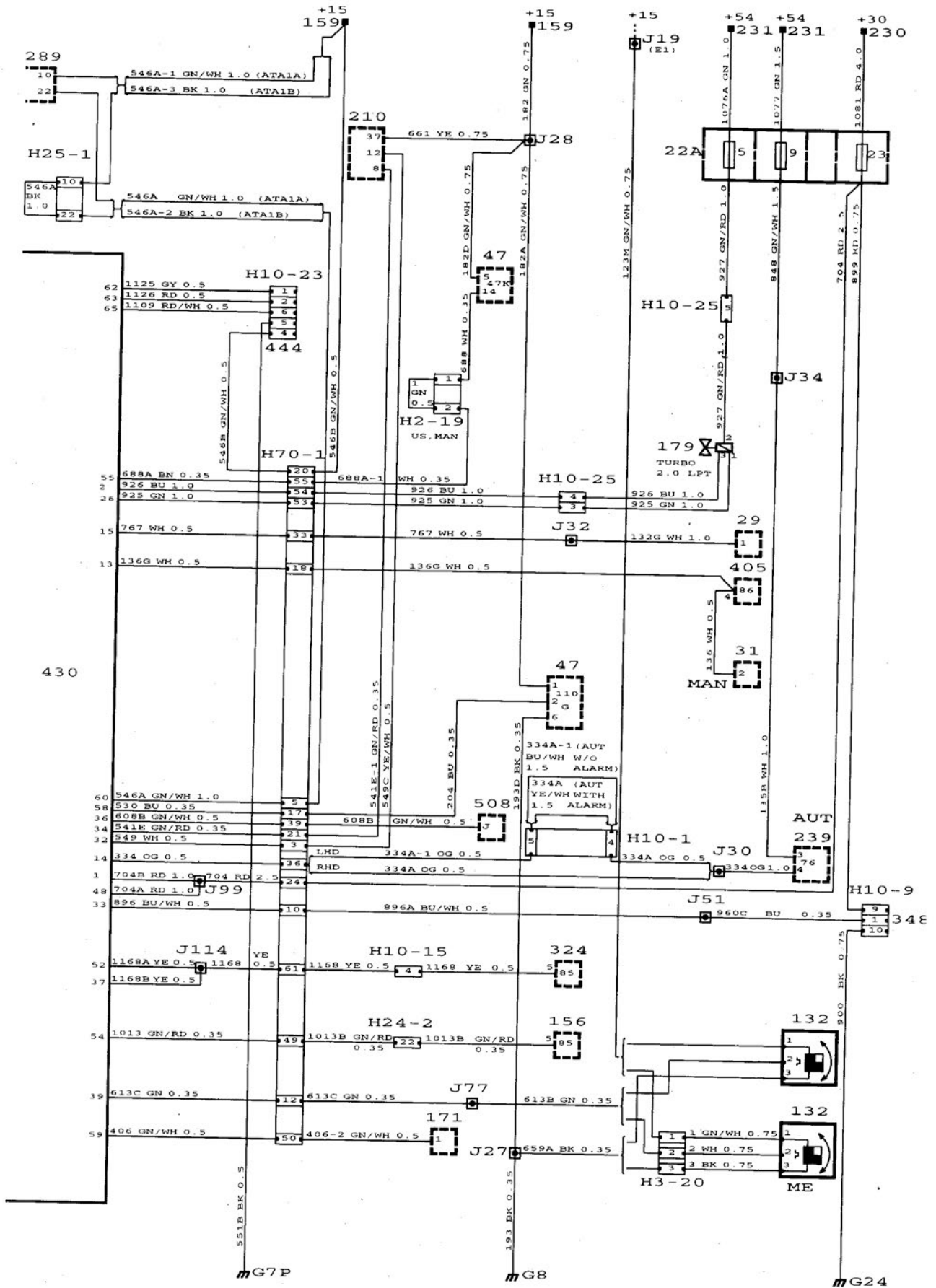

ATA1A = US/CA
ATA1B = SE/EU/GB/ME/PA/LA/AU

Description of operation (cars without ETS)

The Trionic is an engine management system in which fuel injection, ignition timing and boost pressure control are integrated into a single system having a common control module.

There are many similarities between the Trionic, LH and DI/APC systems, but the Trionic incorporates a number of new components and functions.

Compared with earlier LH-DI/APC systems, the most important electrical changes are as follows:

- One control module instead of two.
- Mass air flow sensor 205 is replaced by a sensor for measuring the pressure in intake manifold 431 and intake air temperature sensor 407.
- Knock sensor 178 is replaced by a knock sensor function (ionization measurement) integrated into a new ignition discharge module (346).
- Injectors 206 are controlled sequentially, i.e. the control module can control each injector individually.

Trionic control module

Control module 430 monitors and controls a number of functions.

The control module obtains information from:

- Ignition switch 20
- Brake light switch 29
- Reversing light switch 31
- Idle speed compensation switch 76
- Speed sensor 132
- Oxygen sensor 136
- Antifrost thermostat 171
- Engine coolant temperature sensor 202
- Throttle position sensor 203
- Crankshaft position sensor 345
- Ignition discharge module 346
- Intake air temperature sensor 407
- Manifold absolute pressure sensor 431
- Cruise Control system control module

The control module sends information to:

- SHIFT UP indicator lamp 47K
- Fuel pump relay 102
- Tachometer (rev counter) 110
- A/C and ACC relay 156 (via pressure switch 166)
- Boost pressure control valve 179
- Throttle position sensor 203
- Injectors 206
- EDU trip computer 210 (CHECK ENGINE)
- Main relay 229
- Preheating element, oxygen sensor 271
- Idle air control valve 272
- EVAP canister purge valve 321
- Ignition discharge module 346
- Scan tool diagnostics data link connector 347
- Manifold absolute pressure sensor 431

Adaptation

If the battery or control module has been disconnected, adaptation of the system will have to be performed (NOTE: correct basic charging pressure).

Any diagnostic trouble codes stored in the system will have disappeared, which means that the car must be driven for a while so that the diagnostic trouble codes will be generated afresh.

Power supply

The system is supplied with positive voltage via fuse 13 to relays 443 and 102 when the ignition switch is in the Start or Drive position and also with constant current (via the +30 circuit) to relay 229 and AMF control module 430.

Fuel supply

Fuel is supplied through fuel pump 323 building up pressure in the system.

The fuel supply function is adaptive, which means that the supply of fuel is continually adapted to any wear, changes in components, etc. that may occur.

Data link connector 348

The data link connector for connecting the ISAT scan tool is located under the right-hand front seat.

A direct connection to fuel pump relay 102 has been introduced during the model year.

Spark plug burn-off

Automatic spark plug burn-off is carried out with a burst of sparks every time the engine is switched off.

Burn-off is carried out on all cylinders simultaneously for 5 seconds at a frequency corresponding to 6000 rpm.

Important:

Current for the Trionic engine control module and ignition discharge module is supplied via the engine management system's main relay, which is activated 5 seconds after the engine has been switched off with the ignition key.

Upshift indication 47K

Upshift indication is fitted to cars with a manual gearbox in the US and CA markets (legal requirement).

The system helps the driver to take best advantage of the characteristics of the engine and so achieve as low fuel consumption and emissions as possible. This is accomplished by means of lamp 47K in the main instrument display panel which lights when a higher gear should be engaged, that is to say when engine speed reaches certain levels.

Cars with automatic transmission

When the selector lever is moved to any drive position, contact 76 in transmission range switch 239 closes and causes the control module to raise idling speed to compensate for the increased load.

Tachometer (rev counter)

Tachometer 110 in main instrument display panel 47 is supplied with current via fuse 13 and distribution terminal +15. Control pulses are received from control module 430 to show the engine speed.

Exhaust emission control, Lambda

The system is connected to an adaptive closed loop (Lambda) system which compensates for changes in the fuel-air mixture (due to changes occurring in the system).

Since oxygen sensor 136 continuously measures the oxygen content of the exhaust emissions, the control module can adjust the fuel-air mixture so that it is as close as possible to $\lambda = 1$.

Sensor preheater 271 is connected via fuse 28. Preheating is disconnected via control module 430.

Boost pressure control valve 179

The boost pressure control valve regulates turbo boost pressure by means of input and output signals from the control module.

As boost pressure is continuously adapted to the fuel octane rating and engine working conditions, the setting margins that must normally be observed to avoid engine damage do not have to be followed. Because of this, the fuel being used at any time can be utilized to maximum effect.

Air conditioning, A/C

The Trionic control module receives information from antifrost thermostat 171 to the effect that the A/C system is engaged.

The control module then grounds A/C relay 156 via pressure switch 166.

When the A/C compressor is engaged, the control module increases engine idling speed to compensate for the increased load represented by the compressor.

Coolant temperature sensor 202

Temperature sensor 202 is of NTC type and informs the control module of the temperature of the coolant.

In the event of a break in this signal, the control module simulates a temperature of 26°C.

Throttle position sensor 203

Throttle position sensor 203 provides the control module with information on the position of the throttle butterfly. The sensor gives the angle continuously from idling speed to wide open throttle.

CHECK ENGINE

The CHECK ENGINE lamp (MIL) in EDU 210 lights up when serious and emission-related faults occur in the system.

Idle air control valve 272

The idle air control valve (IACV) is controlled by means of current variations from the Trionic engine control module. The control module controls the valve opening angle so that a regulated air flow is let past the throttle butterfly.

If a fault should arise in the valve, it will be automatically set to a constant idling speed of about 1200 rpm.

EVAP canister purge valve 321

The EVAP canister purge valve located on the evaporative emission canister is opened and closed via the control module.

Crankshaft position sensor 345

The control module obtains information on the position and speed of the crankshaft from the crankshaft position sensor.

The sensor consists of a slotted ring on the crankshaft at the flywheel end and an inductive sensor mounted in the engine block. The inductive sensor works rather like a small alternating current generator, the sinusoidal voltage and frequency of which increase with increasing rpm. The sinusoidal voltage alternates between positive and negative polarity, which is achieved by means of teeth on the slotted ring.

This polarity alternation is used by the control module to ascertain the speed of the engine and to identify which cylinder's piston is at or approaching TDC.

If the sensor is not working, the engine will not start.

Ignition discharge module 346

The ignition discharge module incorporates a transformer which increases the voltage to 400 V, a capacitor in which the voltage is stored, integrated ignition coils (not replaceable) and a built-in knock sensing function.

⚠ WARNING

Attempting to start the engine with the ignition discharge module removed and with the spark plugs not grounded can ruin the ignition discharge module.

Intake air temperature sensor 407

The intake air temperature sensor is located in the intake manifold. It is of NTC type and sends a continuous signal to the control module about the air temperature.

Low temperature = High voltage

High temperature = Low voltage

On the basis of the current air pressure (from manifold absolute pressure sensor 431) and the temperature of the intake air, the current air mass can be determined.

Manifold absolute pressure sensor 431

The Trionic system incorporates manifold absolute pressure sensor 431 which continuously senses the pressure in the intake manifold.

The manifold absolute pressure (MAP) sensor passes on this information to the Trionic control module in the form of voltage signals.

Low pressure = Low voltage

High pressure = High voltage

Using the current air pressure and temperature data (from intake air temperature sensor 407) in the intake manifold, current air mass can be ascertained.

Fault diagnosis

The ISAT scan tool is used for fault diagnosis and reading diagnostic trouble codes. For more information concerning fault diagnosis in the Trionic system, refer to Service Manual "2:7 Engine control system TRIONIC".

Component locations

22A	Fuse board behind the cover flap in the glove box.	231	Distribution terminal (+54 circuit) in main fuse box behind the glove box.
29	Brake light switch beside the brake pedal.	239	Selector lever switch (automatic transmission) adjacent to the selector lever.
31	Reversing light switch manual gearbox: on left-hand side of gearbox. automatic transmission: in transmission range switch 239 adjacent to the selector lever.	271	Heating element, oxygen sensor, integrated into the sensor.
	<i>in the main instrument display panel</i>	272	Idle air control valve in the middle of the intake manifold.
47C	Coolant temperature gauge.	289	Control module, anti-theft alarm, on the right-hand side under the dashboard behind the knee shield.
47K	SHIFT UP indicator light.	321	EVAP canister purge valve in the right-hand wheel housing.
76	Idling speed increase contact in transmission range switch 239 adjacent to the selector lever.	323	Fuel pump in fuel tank under luggage compartment floor.
102	Fuel pump relay in main fuse box behind the glove box.	324	Relay, secondary air injection pump, in main fuse box in front of the battery.
110	Tachometer in the main instrument display panel.	345	Crankshaft position sensor, behind the belt pulley on the oil pump housing.
132	Speed sensor in the speedometer in the main instrument display panel.	346	Ignition discharge module on valve cover.
136	Oxygen sensor on exhaust pipe adjacent to the manifold.	348	Scan tool diagnostics data link connector under the right-hand seat.
156	A/C compressor relay in main fuse box in the engine bay.	(H10-9)	
157	Spark plugs, on the top of the engine, under the cover.	407	Intake air temperature sensor, in engine bay on the intake manifold.
159	Distribution terminal (+15 circuit) in main fuse box behind the glove box.	430	Saab Trionic control module, in engine bay behind the bulkhead partition.
171	Antifrost thermostat on the evaporator casing below the windscreen on the right-hand side.	431	Manifold absolute pressure sensor, in engine bay on bulkhead partition to the left.
179	Boost pressure control valve (BPC) on radiator fan cowl.	444	Trionic data link connector (for production only).
202	Engine coolant temperature sensor (NTC resistor) on the intake manifold flange between cylinders 2 and 3.	(H-10-23)	
203	Throttle position sensor on the throttle body.	508	Cruise Control system control module, adjacent to the battery tray.
206	Injectors: 2.0l: on the bottom of the intake manifold. 2.3l: on the top of the intake manifold.		
210	EDU trip computer in the main instrument display panel.		
229	Main relay, engine management system, in main fuse box behind the glove box.		
230	Distribution terminal (+30 circuit) in main fuse box behind the glove box.		

Continued on next page.

Component location (contd.)

2-pin connectors

- H2-19 Under the dashboard to the left of the steering wheel.
- H2-88 Beside control module 430.

3-pin connectors

- H3-9 In the engine bay below the intake manifold.
- H3-20 Behind the main instrument display panel adjacent to the speedometer (ME).

4-pin connectors

- H4-4 Beside the fuel pump under the luggage compartment floor.
- H4-16 In the engine bay behind the bulk-head partition, at far right (black).

6-pin connector

- H6-5 In the front right-hand corner behind the light cluster beside the washer fluid reservoir.

10-pin connectors

- H10-15 Behind the left-hand headlamp.
- H10-18 On the electronic ignition module.
- H10-25 Behind the left-hand headlamp.

24-pin connector

- H24-2 Behind the left-hand headlamp on a bracket.

25-pin connector

- H25-1 Instead of anti-theft alarm control module.

70-pin connector

- H70-1 In the engine bay, behind the bulk-head partition.

- G5 Grounding point, rear seat, under the left-hand part of the seat.
- G8 Grounding point, dashboard, beside the front left-hand loudspeaker socket.
- G7 Grounding point, engine, at the rear of the engine on a sheet metal bracket below the intake manifold.
- G24 Grounding point, right-hand front seat member.

Components

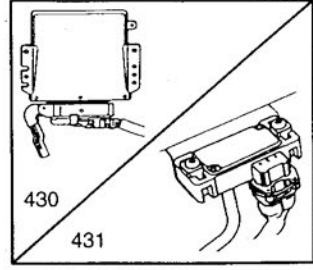
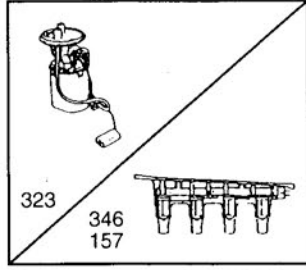
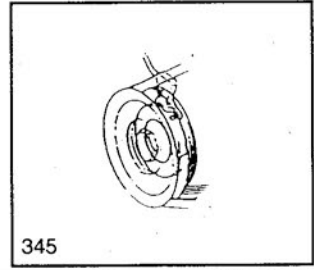
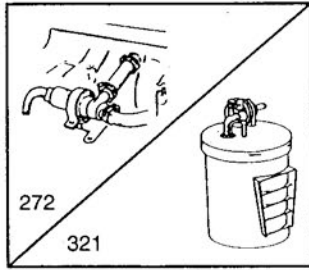
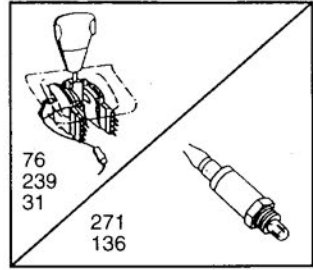
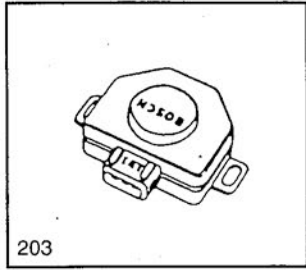
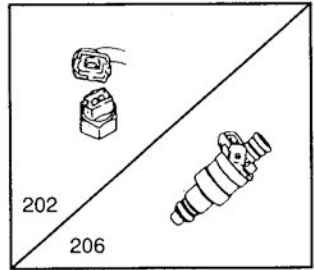
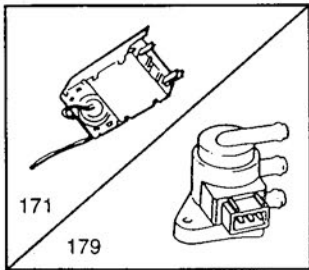
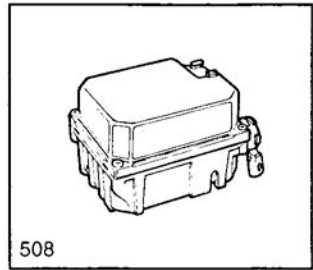
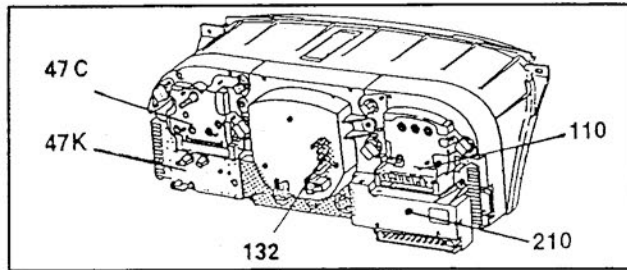
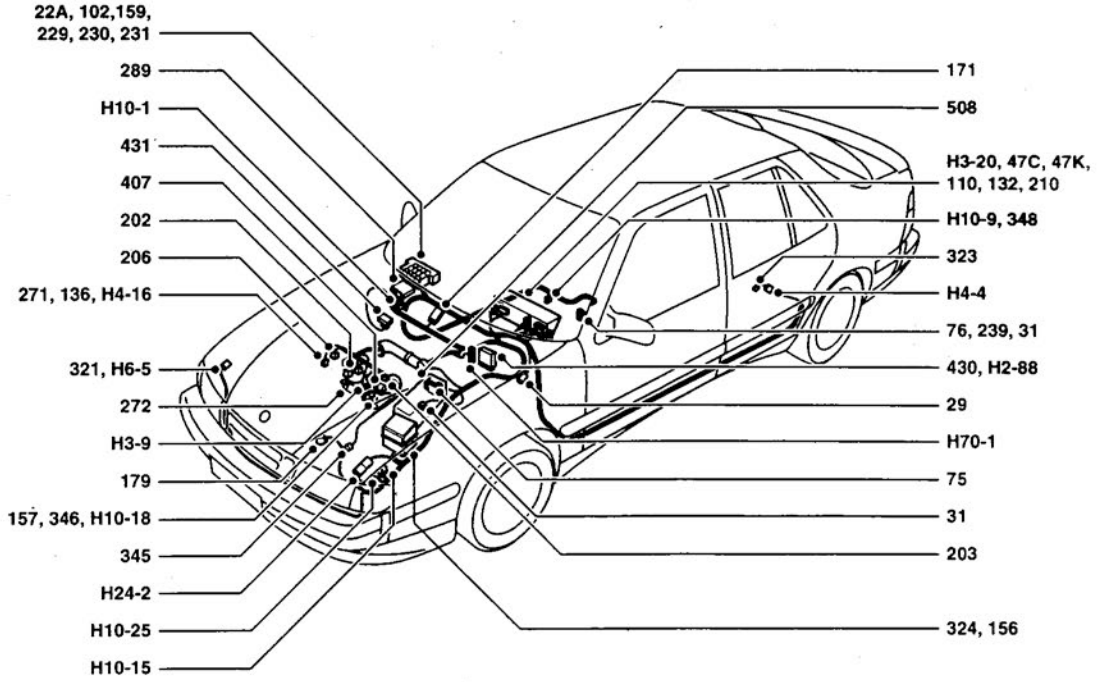

Trionic engine management system with ETS

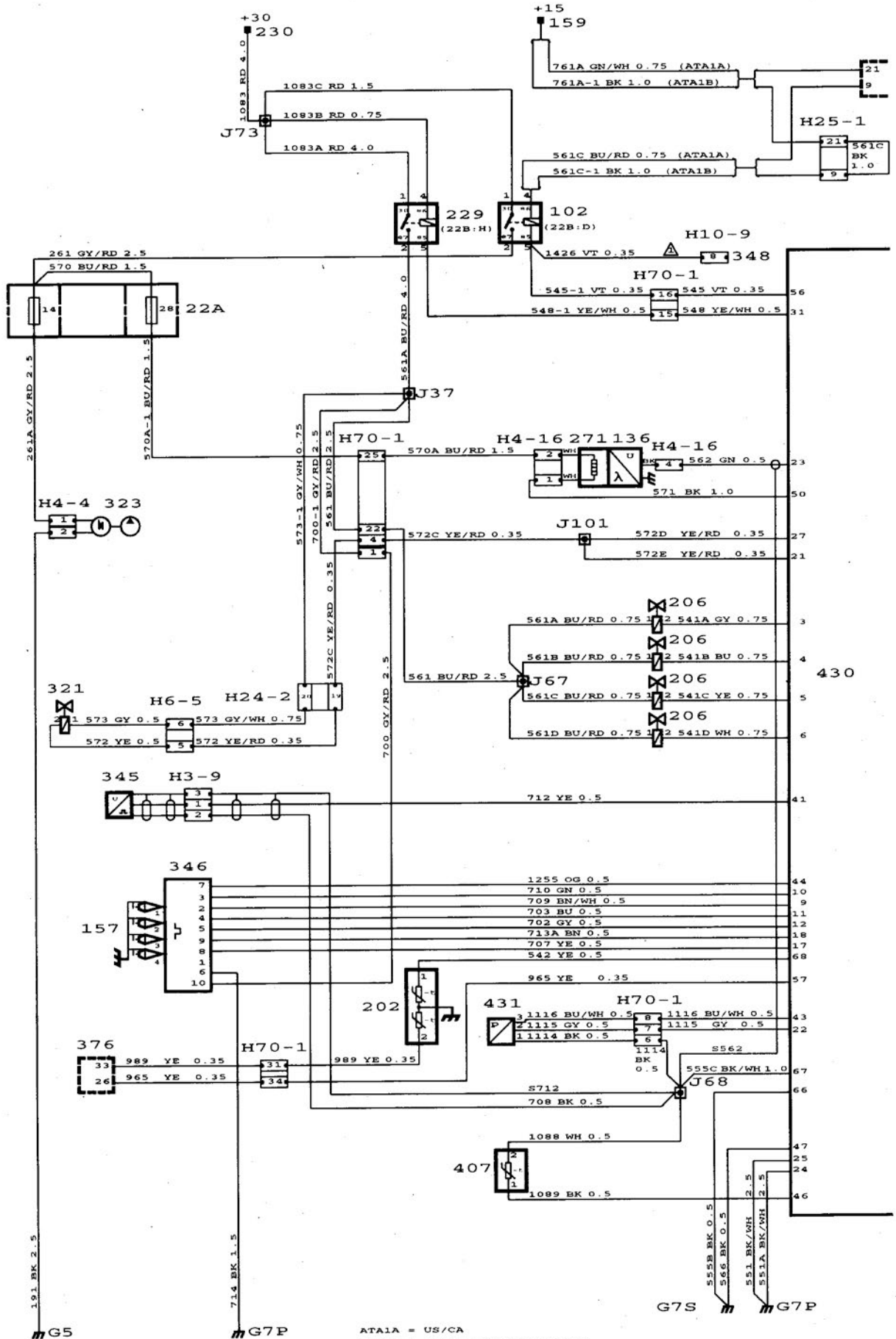

Trionic engine management system with ETS

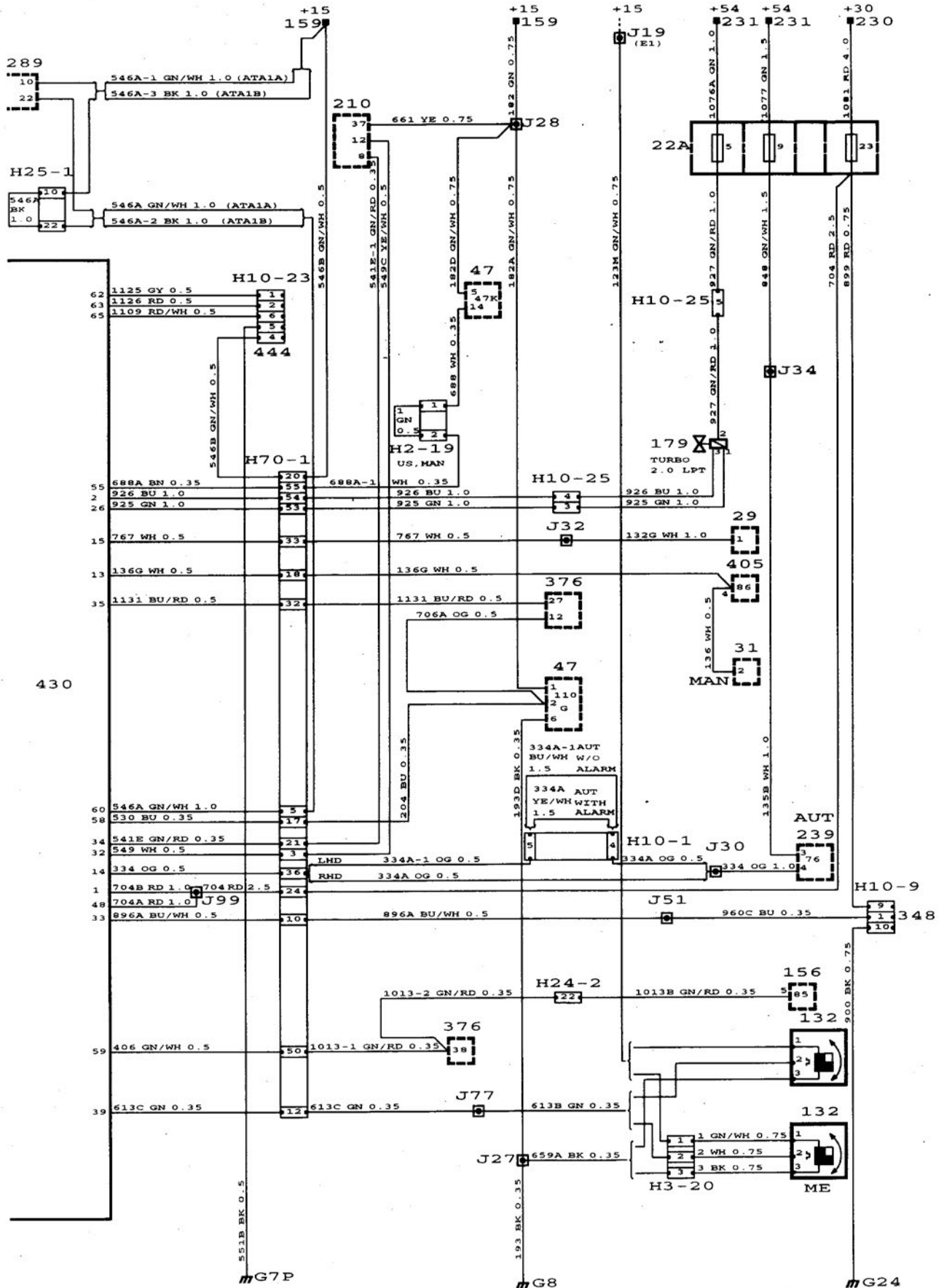

430

ATA1A = US/CA
ATA1B = SE/EU/GB/ME/PA/LA/AU

Description of operation

The method of operation of the Trionic system is described on page 66. Only the additional function for the ETS is described here.

ETS control module 376

When the Trionic engine management system is used in cars with ETS, the ETS control module (376) has the following functions in the Trionic system:

- In order to enable the ETS control module to increase and regulate engine speed when starting from cold, engine coolant temperature sensor 202 sends coolant temperature data to the ETS control module.
- The ETS control module grounds A/C relay 156.
- The ETS control module obtains data on the current engine speed from the Trionic control module.
- Integrated into the ETS control module is an idle speed control function which regulates the flow of air passing through the throttle valve. Should a fault arise in the idle speed control function, idling speed will be automatically set to about 1200 rpm. It remains constant at this speed.

Pump and valve for secondary air injection

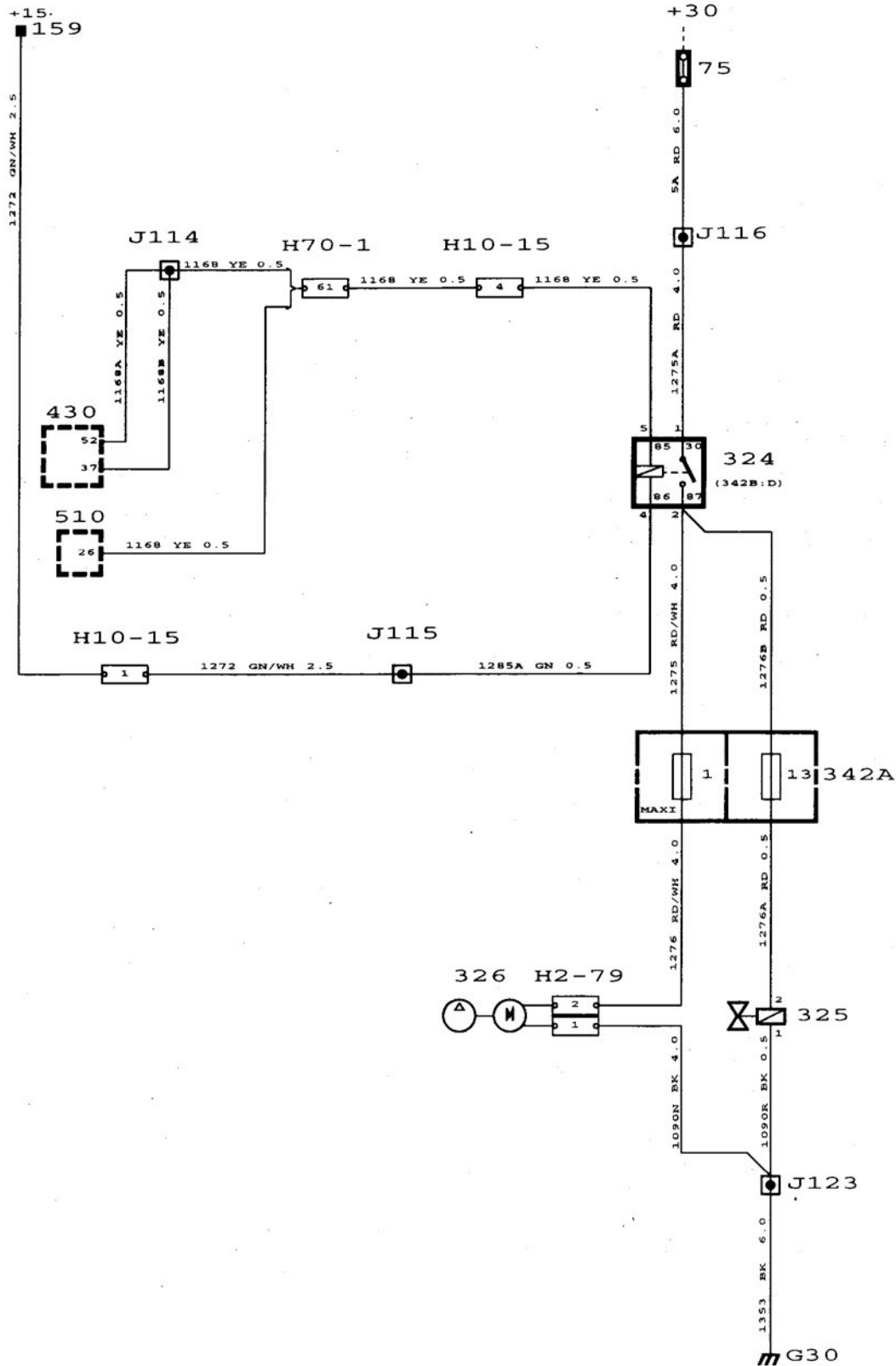

Description of operation

In certain markets, the engine management system is equipped with a system for secondary air injection. This consists of an air pump and a valve. Both these components are controlled by their own control modules. These ground relay 324, the coil of which is supplied from distribution terminal 159. The relay contact is connected to distribution block 75.

To get the catalytic converter working as soon as possible after a cold start, ambient air is pumped into the exhaust manifold where the oxygen in the air starts a chemical combustion process.

When the engine has started, secondary air injection pump 326 starts and boost pressure control valve 325 opens the connection to the exhaust manifold.

This function is time and temperature dependent. The boost pressure control valve closes and the pump stops after a maximum of 80 seconds or when the engine temperature reaches 65°C.

Secondary air injection pump 326

When the Trionic or Motronic control module grounds relay 324, current is supplied to the pump via the relay contact and fuse 1 (maxi). The pump then starts.

Secondary air injection control valve 325

When the relay is activated, current is supplied to the valve via fuse 13. The valve then opens.

Fault diagnosis hints

- 1 Check that current is supplied to the relay contact.
- 2 Check fuse 1 (maxi) and fuse 13.
- 3 Check the cables, connectors and grounding points in question.

Component locations

- 75 Distribution block (+30 circuit), on the battery tray.
- 159 Distribution terminal (+15 circuit), in main fuse box behind the glove box flap.
- 324 Relay, secondary air injection, in main fuse box in front of the battery.
- 325 Secondary air injector, behind the left-hand headlamp.
- 326 Secondary air injection pump, behind the left-hand headlamp.
- 342A Main fuse box, in engine bay in front of the battery.
- 430 Saab Trionic control module, in engine bay on the left behind the bulkhead partition.
- 510 Motronic 2.8.1 control module, in engine bay behind the bulkhead partition.
- 2-pin connector*
- H2-79 Connector beside the air pump.
10-pin connector
- H10-15 Behind the left-hand headlamp.
70-pin connector
- H70-1 In the engine bay, behind the bulkhead partition.
- G30 Grounding point, on left-hand structural member behind the left-hand headlamp.

Components

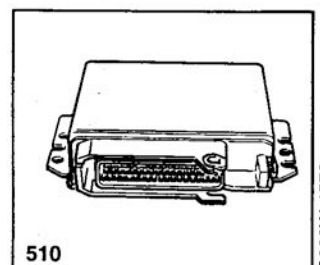
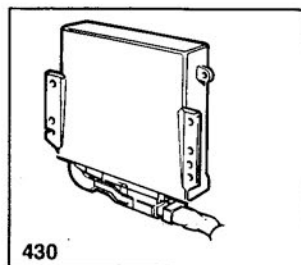
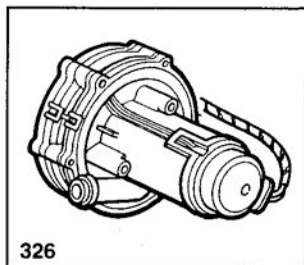
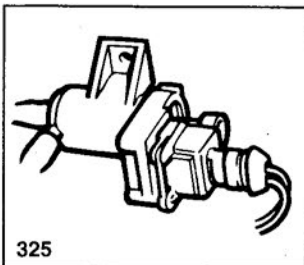
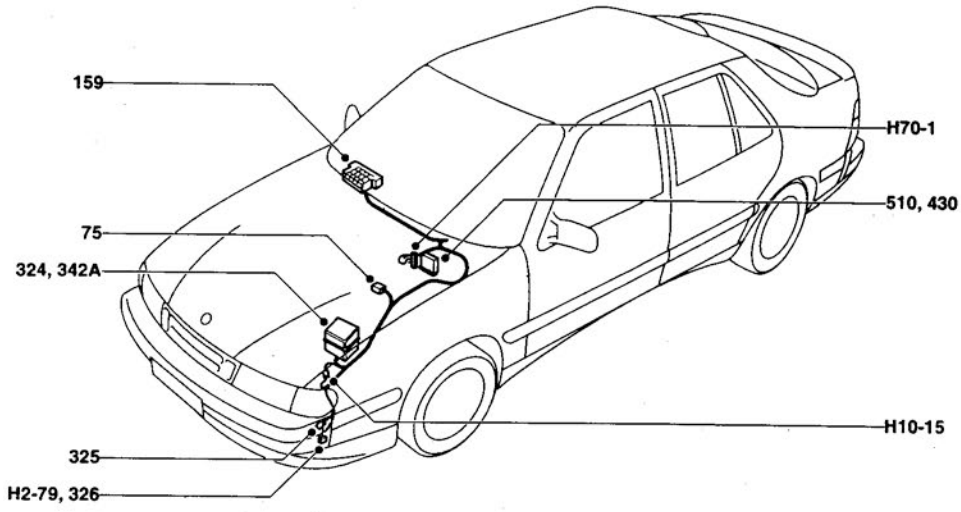

C200W-4572

Motronic 2.8.1 engine management system

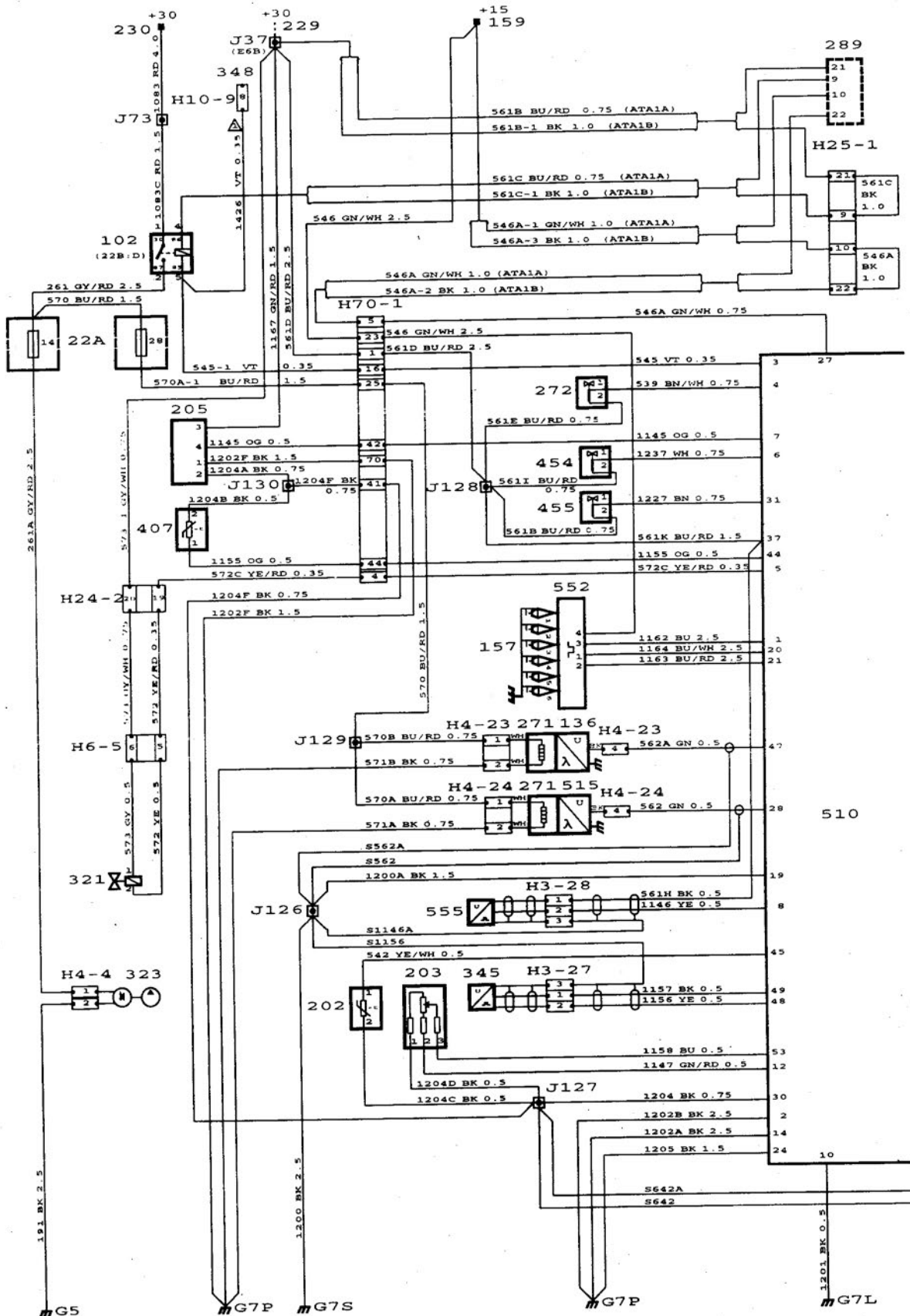

ATA1A = US/CA
 ATA1B = SE/RU/GB/ME/PA/LA/AU

Motronic 2.8.1 engine management system

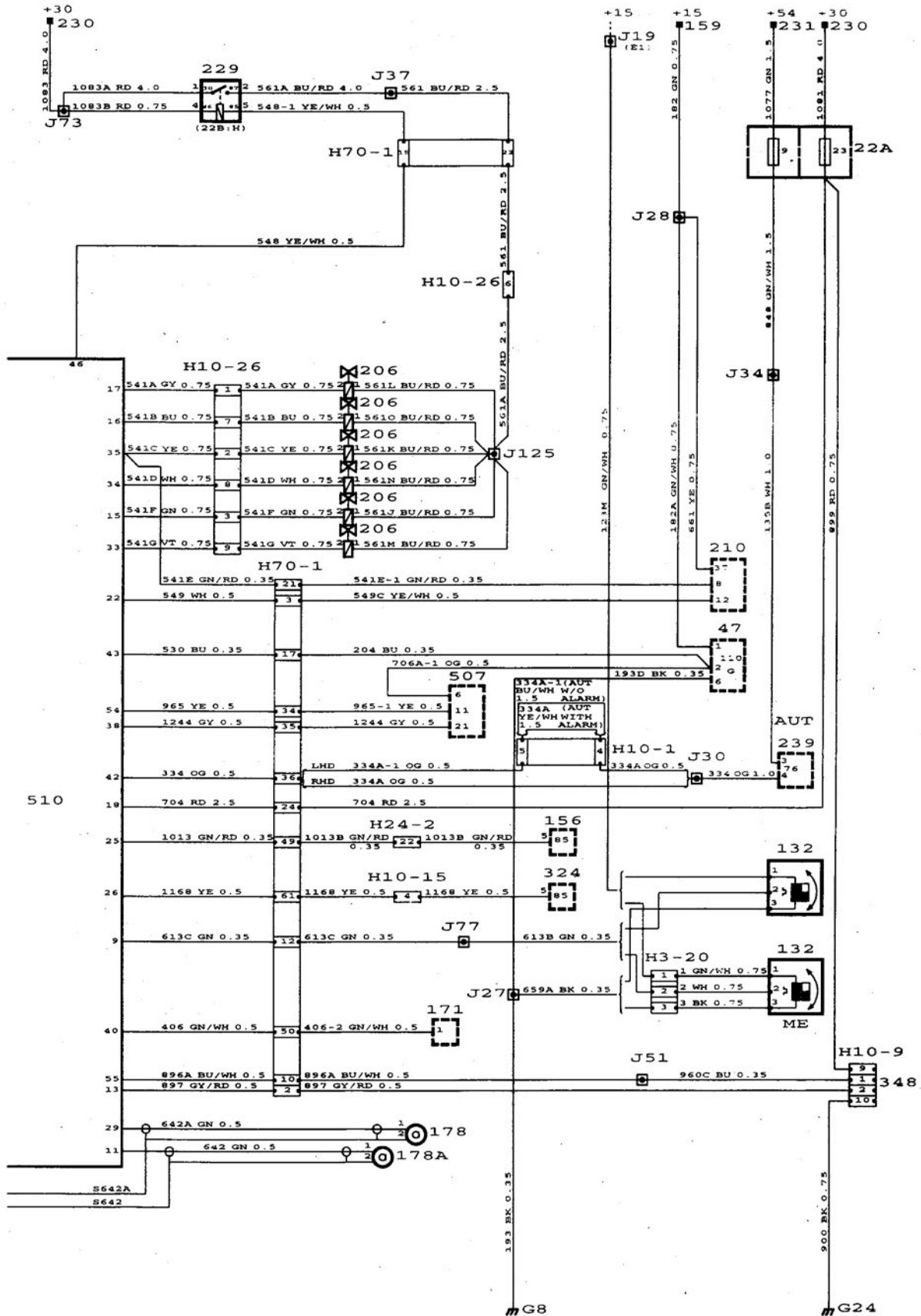

Description of operation

The Motronic 2.8.1 is an engine management system for V6 engines. It controls both ignition timing and fuel injection from a single control module.

The Motronic system has sequential multiport fuel injection and individual control of ignition timing in connection with knocking in any of the cylinders. This function is adaptive.

Expressed in simplified terms, it could be said that the MOTRONIC system is a combined electronic fuel injection system and electronic ignition system with knock sensor.

The fuel injection system has an advanced function in that injection is sequential. The ignition power module is integrated into the control module.

M2.8.1 control module

Control module 510 monitors and controls a number of functions.

The control module obtains information from:

- Mass air flow sensor 205
- Engine coolant temperature sensor 202
- Front heated oxygen sensor 136
- Rear heated oxygen sensor 515
- Crankshaft position sensor 345
- Camshaft position sensor 555
- TTS control module 507
- Front knock sensor 178
- Rear knock sensor 178A
- Throttle position sensor 203
- A/C status via antifrost thermostat 171
- Intake air temperature sensor 407
- Speed sensor 132
- Transmission range position (automatic transmission) 239

The control module sends information to:

- Injectors 206
- Ignition coil unit 552
- A/C and ACC relay 156
- Main relay 229
- Fuel pump relay 102
- EDU control module 210
- Data link connector 348
- Throttle position sensor 203
- EVAP canister purge valve 321
- Idle air control valve (IAC) 272
- Secondary air injection pump 326
- Secondary air injection control valve 325
- Boost pressure control valves for variable intake manifolds 454, 455
- Engine speed

Power supply

Current (+30 circuit) is supplied via fuse 23 to pin 18 of the control module. This current is used for the control module's memory.

Current (+15 circuit) is supplied via fuse 13 to pin 27 of the control module. When the ignition switch is turned to the Drive position, main relay 229 is grounded via pin 46 of the control module, causing the relay to operate. The main relay supplies the control module with current (+30 circuit) on pin 37.

Engine speed

Engine speed data is sent via pin 4 to tachometer 110 in the main instrument display panel and the TTS control module.

Oxygen sensors 136 and 515

The oxygen sensors, one for the front and one for the rear cylinder block, are mounted on the exhaust pipe. Their task is to give the control module data about the composition of the exhaust gases (oxygen content).

Because the sensors continually measure the oxygen content of the exhaust gases, the control module can correct the fuel-air mixture and bring it as close to $\lambda = 1$ as possible.

Preheating of oxygen sensor 271

To work effectively, the sensor must be warm. The sensors are therefore equipped with an integrated heating element so that they will attain working temperature as quickly as possible. This is known as preheating.

Air conditioning, A/C

The Motronic control module receives information from the A/C switch/ACC unit as to whether the A/C system is engaged. This information arrives via pressure switch 166 and antifrost thermostat 171.

The control module then grounds relay 156 and the compressor starts. When the compressor is engaged, the control module compensates for the increased load on the engine caused by the compressor.

If the engine coolant temperature rises to 115°C (239 °F), the EDU control module breaks the connection and the compressor stops.

Coolant temperature sensor 202

The coolant temperature sensor is of NTC type and provides the control module with data about the temperature of the coolant.

If there is an open circuit in the sensor, the control module simulates a substitute value.

Throttle position sensor 203

The throttle position sensor provides data about the position of the throttle butterfly valve.

The sensor is a potentiometer which provides continuous data from fully closed throttle to wide open throttle.

Idle air control valve 272

The idle air control valve is controlled by the control module, which regulates the opening angle of the butterfly valve in order to maintain the idling speed constant.

For instance, this means that the butterfly valve opens on engagement of the A/C in order to compensate for the increased load on the engine.

Should a fault arise in the circuit, the butterfly valve will be automatically set to a constant idling speed of at least 1000 rpm.

EVAP canister purge valve 321

The EVAP canister purge valve, located in the right-hand side of the engine bay, is controlled by the control module on the basis of engine temperature, engine speed and load.

The valve opens under specific conditions and admits fuel vapours from the evaporative emission canister to the intake manifold where they are burnt with the regular fuel-air mixture.

Crankshaft position sensor 345

The control module obtains information on the position and speed of the crankshaft from the crankshaft position sensor.

The sensor consists of a slotted ring on the crankshaft at the flywheel end and an inductive sensor mounted in the engine block. The inductive sensor works rather like a small alternating current generator, the sinusoidal voltage and frequency of which increase with increasing rpm. The sinusoidal voltage alternates between positive and negative polarity, which is achieved by means of teeth on the slotted ring.

This polarity alternation is used by the control module to ascertain the speed of the engine and to identify which cylinder's piston is at or approaching TDC.

If the sensor is not working, the engine will not start.

Camshaft position sensor 555

The camshaft position sensor is of the Hall sensor type. It senses the position of the camshaft for cylinder 1 by means of a ridge on the camshaft. When this ridge passes the sensor, the control module input is grounded.

Mass air flow sensor 205

The mass air flow sensor registers the air mass used by the engine, which is proportional to the engine load.

If there is a break in this function, the control module obtains data from the throttle position sensor.

Knock sensors 178 and 178A

The knock sensors, 178 for the front and 178A for the rear cylinder block, sense the engine's tendency to knock and convert any knocking into a voltage signal. The control module processes the voltage signal and adjusts the ignition timing to achieve optimum performance and minimum emission levels.

Intake air temperature sensor 407

The intake air temperature sensor is located in the intake manifold. It is of NTC type and sends a continuous signal to the control module about the air temperature.

Low temperature = High voltage

High temperature = Low voltage

On the basis of the current air pressure (from manifold absolute pressure sensor 431) and the temperature of the intake air, the current air mass can be determined.

Control valves 454 and 455

To achieve even and high torque over a wide engine speed range, the engine is equipped with a variable intake manifold.

Using the control valves, which are regulated by the control module, three different pipe lengths can be obtained.

Ignition coil module 552

The ignition system is inductive but has no distributor. The module has three ignition coils.

CHECK ENGINE

In the event of a fault in the engine management system or if the emission values are incorrect, the CHECK ENGINE lamp (MIL) in the EDU control module will light up.

Data link connector 348

The data link connector for connecting the ISAT scan tool is located under the right-hand front seat.

A direct connection to fuel pump relay 102 has been introduced during the model year.

Fault diagnosis hints

The ISAT scan tool is used for fault diagnosis and reading diagnostic trouble codes. For more information concerning fault diagnosis in the Motronic system, refer to Service Manual "2:7 Motronic 2.8.1 Engine management system".

Component locations

22A	Fuse board behind the cover flap in the glove box. <i>in the main instrument display panel</i>	272	Idle air control valve, in the middle of the intake manifold.
47C	Coolant temperature gauge	289	Anti-theft alarm control module, on the right-hand side below the dashboard behind the knee shield.
47K	SHIFT UP indicator light.	321	EVAP canister purge valve in the right-hand wheel housing.
76	Idling speed increase contact in transmission range switch 239 adjacent to the selector lever.	323	Fuel pump in fuel tank under luggage compartment floor.
102	Fuel pump relay in main fuse box behind the glove box.	324	Relay, secondary air injection pump, in main fuse box in front of the battery.
110	Tachometer in the main instrument display panel.	345	Crankshaft position sensor, behind the belt pulley on the oil pump housing.
132	Speed sensor in the speedometer in the main instrument display panel.	348	Scan tool diagnostics data link connector under the right-hand seat.
136	Oxygen sensor on the exhaust pipe adjacent to the manifold.	(H10-9)	
156	A/C compressor relay in main fuse box in front of the battery.	407	Intake air temperature sensor, in engine bay on the intake manifold.
157	Spark plugs, on the top of the engine, under the cover.	454	Control valve, inner VIM flap, on the intake manifold.
159	Distribution terminal (+15 circuit) in main fuse box behind the glove box.	455	Control valve, outer VIM flap, on the intake manifold.
171	Antifrost thermostat on the evaporator casing below the windscreen on the right-hand side.	507	TCS Control module, V6, under left-hand front seat.
178	Knock sensor on the front cylinder block.	508	Cruise Control system control module, adjacent to the battery tray.
178A	Knock sensor on the rear cylinder block.	510	Motronic 2.8.1 control module in the engine bay behind the bulk-head partition.
202	Engine coolant temperature sensor on the intake manifold flange between cylinders 2 and 3.	515	Oxygen sensor, cylinder bank 1, in the exhaust manifold.
203	Throttle position sensor on the throttle body.	552	Ignition coil module, on left-hand side of engine.
205	Mass air flow sensor on the intake manifold after the air cleaner.	555	Camshaft position sensor, adjacent to the camshaft sprocket.
206	Injectors on the intake manifold.		
210	EDU trip computer in the main instrument display panel.		
229	Main relay, engine management system, in main fuse box behind the glove box.		
230	Distribution terminal (+30 circuit) in main fuse box behind the glove box.		
231	Distribution terminal (+54 circuit) in main fuse box behind the glove box.		
239	Selector lever switch (automatic transmission) by the selector lever.		
271	Heating element, oxygen sensor, integrated into the sensor.		

Continued on next page.

Component location (contd.)

	<i>2-pin connector</i>
H2-88	Beside control module 430.
	<i>3-pin connectors</i>
H3-20	Behind the main instrument display panel adjacent to the speedometer (ME).
H3-27	On a bracket just behind the radiator, at bottom.
	<i>4-pin connectors</i>
H4-4	Beside the fuel pump under the luggage compartment floor.
H4-23	On a bracket just behind the radiator, at bottom.
H4-24	On a bracket to the left of the rear exhaust manifold.
	<i>6-pin connector</i>
H6-5	In the front right-hand corner behind the light cluster beside the washer fluid reservoir.
	<i>10-pin connector</i>
H10-15	Behind the left-hand headlamp.
	<i>24-pin connector</i>
H24-2	Behind the left-hand headlamp on a bracket.
	<i>25-pin connector</i>
H25-1	Instead of the anti-theft alarm's control module.
	<i>70-pin connector</i>
H70-1	In the engine bay, behind the bulkhead partition.
G5	Grounding point, rear seat, under the left-hand part of the seat.
G8	Grounding point, dashboard, beside the front left-hand loudspeaker socket.
G7	Grounding point, engine, at the rear of the engine on a sheet metal bracket below the intake manifold.
G24	Grounding point, right-hand front seat member.

Components

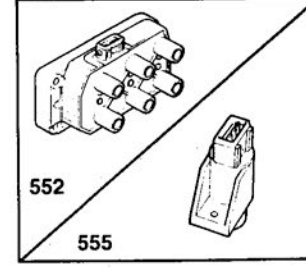
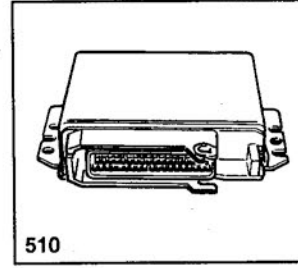
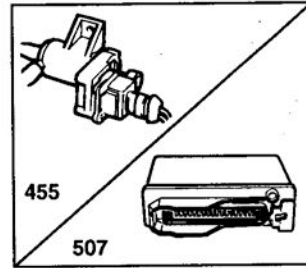
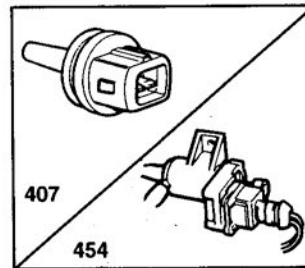
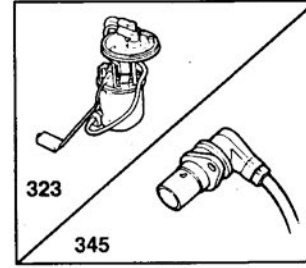
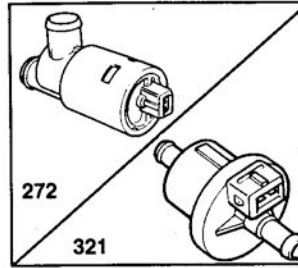
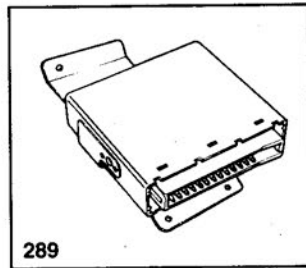
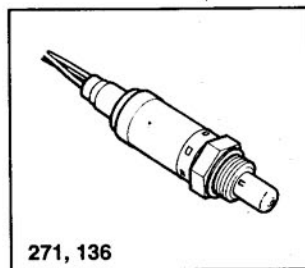
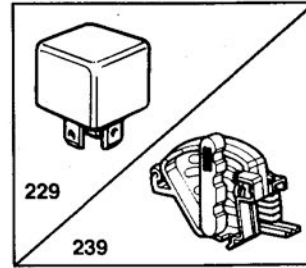
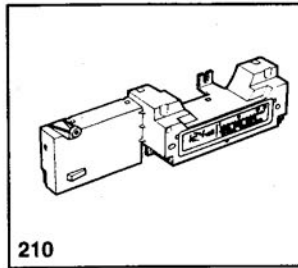
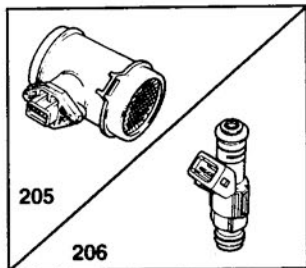
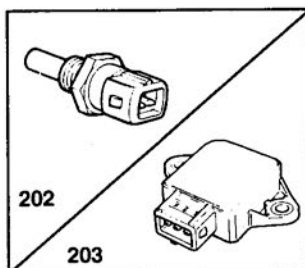
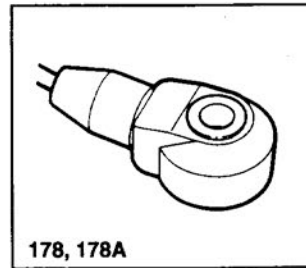
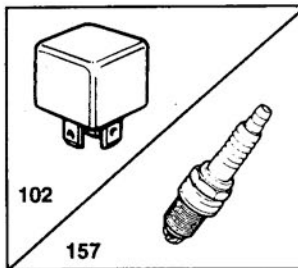
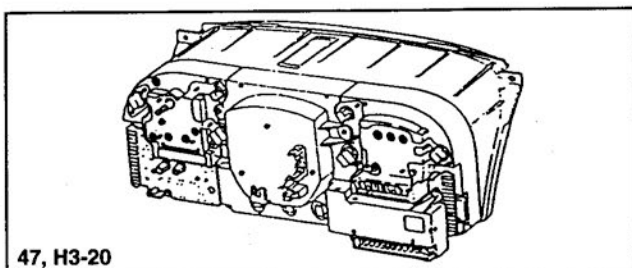
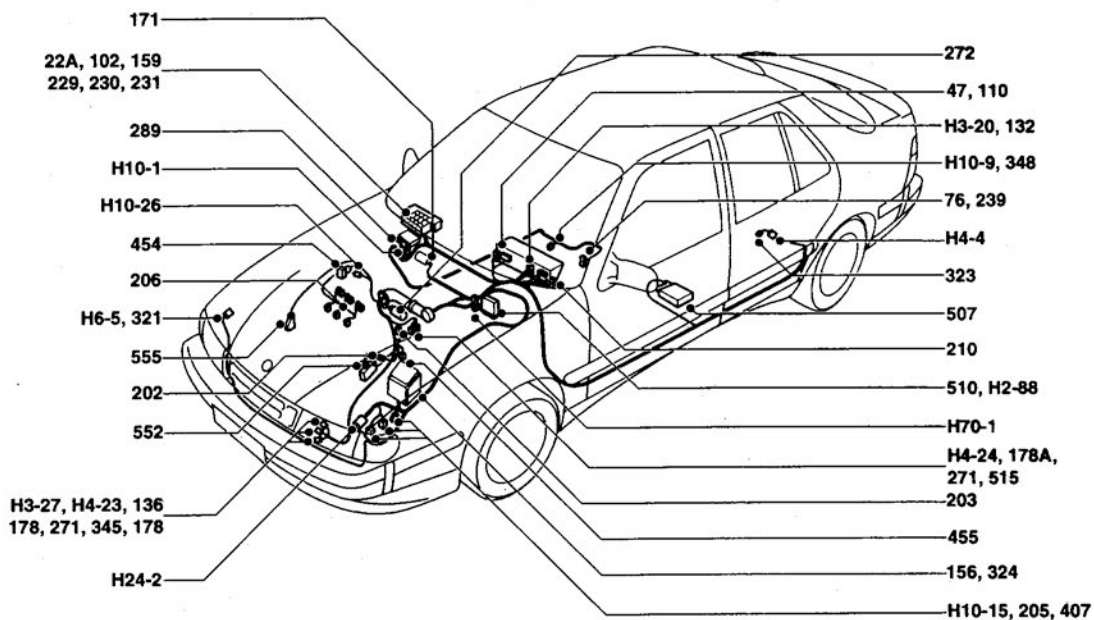

C200W-4570

Circulation pump



Description of operation

Cars with a V6 engine are fitted with a coolant circulation pump. The pump starts when the ignition switch is turned to the Drive position. Current is supplied to the pump from distribution terminal 231 via fuse 5.

Fault diagnosis hints

- 1 Check the voltage on distribution terminal 231.
- 2 Check fuse 5.
- 3 Check the relevant wiring harness connections, connectors and grounding points.

Component locations

- 22A Main fuse box behind the glove box cover flap.
- 231 Distribution terminal (+54 circuit) in main fuse box behind the glove box.
- 453 Circulation pump beside the battery tray.

Components

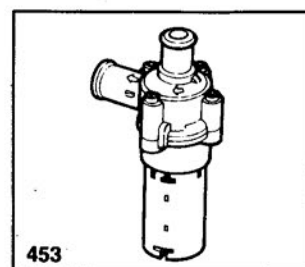
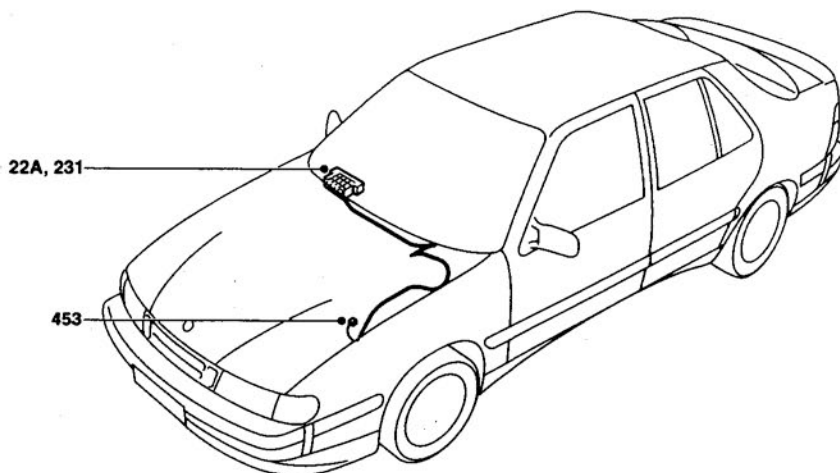

453

C261W-4574

TCS (Traction Control System) V6

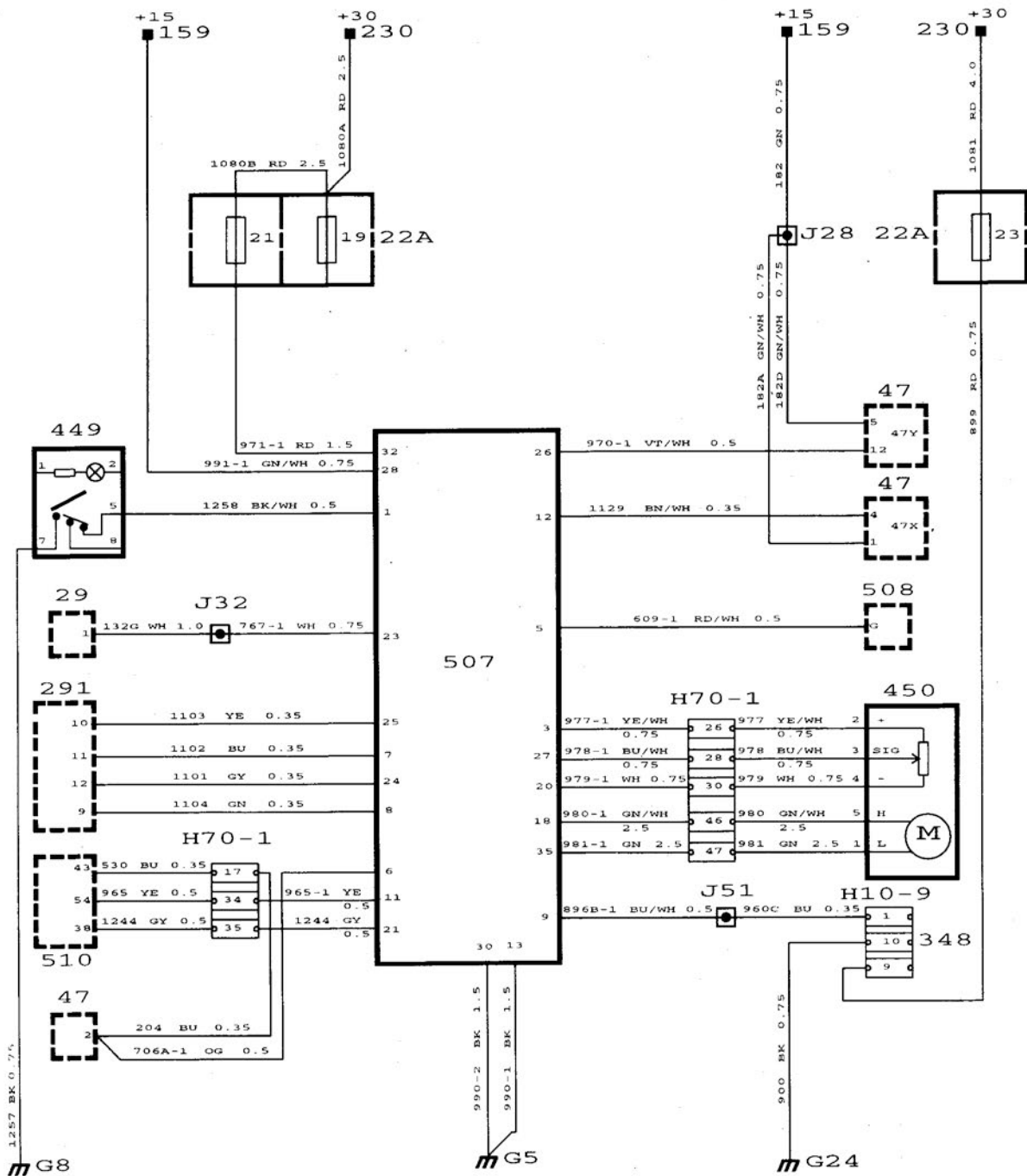

Description of operation

The TCS system is used on cars equipped with the Motronic 2.8.1 engine management system. It is also called the **Twin Throttle System (TTS)**.

This system does not work by controlling the brakes but only by controlling the throttle butterfly valve.

The TCS system, which controls the anti-spin function, does it so smoothly and imperceptibly that the driver only notices that it is in operation by the TCS lamp lighting up in the main instrument display panel.

TCS control module 507

The control module handles traction control and regulates actuator motor 450. It is located under the right-hand front seat.

Control module inputs

- ABS control module 291
- Motronic 2.8.1 control module 510
- Actuator motor 450
- TCS ON/OFF Switch 449
- Brake light switch 29
- Data link connector 348

Control module outputs

- Actuator motor 450
- Cruise Control 508
- Main instrument display panel 47
- Motronic 2.8.1 control module 510
- Data link connector 348

Power supply

The TCS control module is supplied with battery positive voltage on pin 32 via fuse 21. This voltage supply is also used to power the actuator motor.

With the ignition switch in the Drive position, current (+15 circuit) is applied to pin 28.

Grounding

The control module is grounded via pins 13 and 30 at grounding point G5.

TCS throttle body

The TCS throttle body consists of housing, throttle butterfly, actuator motor and lever.

It is mounted after the conventional throttle body.

The control module receives data on the position of the butterfly valve from the position sensor, which is integrated into the motor module, via connection 27.

Actuator motor 415

The TCS throttle butterfly actuator motor is supplied with current via pins 18 and 35.

Wheel speed information

To determine whether wheel spin is occurring on any of the drive wheels, the control module obtains data on the speed of the front wheels from the ABS control module.

The speed of the rear wheels is used as a reference and this information is therefore also supplied to the TCS control module.

Engine speed

Information about the engine speed is obtained from the Motronic control module. This is used by the control module, together with information about the positions of the main and TCS throttles, to calculate engine torque.

Brake light switch

When the brake is activated, battery positive voltage is applied to pin 23 of the control module which then disconnects the Cruise Control system.

TCS ON/OFF Switch 449

When the switch is activated, the TCS system will be disconnected as long as vehicle speed is below 60 km/h. TCS OFF indicator lamp 47Y lights up.

The TCS function can be reconnected at any speed.

The TCS function is automatically activated when the ignition switch is turned to the Drive position from the OFF position.

TCS indicator lamp

The indicator lamp lights up when the TCS system is in operation.

TCS OFF warning lamp

The warning lamp stays on continuously when there is a system fault or when the system has been manually deactivated with switch 449.

For more information about the TCS system and its operation, see Service Manual "2:5 TCS Traction Control".

Fault diagnosis hints

The ISAT scan tool is used for fault diagnosis and obtaining readouts of diagnostic trouble codes.

For further information about fault diagnosis in the TCS system, see Service Manual "**2:5 TCS Traction Control System**".

Component locations

22A	Fuse board behind the cover flap in the glove box.
29	Brake light switch beside the brake pedal. <i>in the main instrument display panel</i>
47Y	TCS OFF indicator lamp.
47X	TCS indicator lamp
159	Distribution terminal (+15 circuit) in main fuse box behind the glove box cover flap.
230	Distribution terminal (+30 circuit) in main fuse box behind the glove box cover flap.
291	ABS control module on the battery tray.
348 (H10-9)	Scan tool diagnostics data link connector under the right-hand seat.
449	TCS ON/OFF switch in the dash-board.
450	TTS actuator motor on the throttle body.
507	TCS control module, V6, under left-hand seat.
508	Cruise Control system control module, adjacent to the battery tray.
510	Motronic 2.8.1 control module, in engine bay behind the bulkhead partition. <i>70-pin connector</i>
H70-1	In the engine bay, behind the bulkhead partition.
G5	Grounding point, under the rear seat on the left-hand side.
G8	Grounding point, on the stiffening member under the left-hand loud-speaker grille.
G24	Grounding point, on the right-hand front seat member.

Components

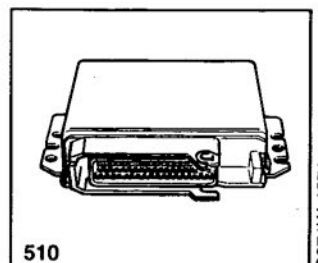
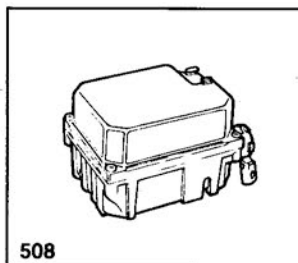
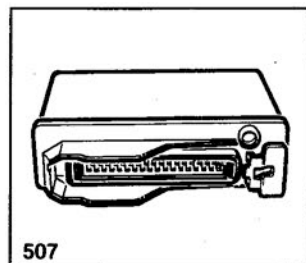
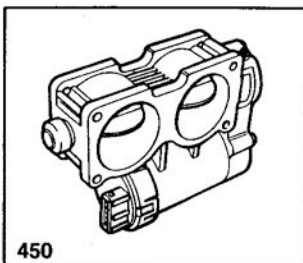
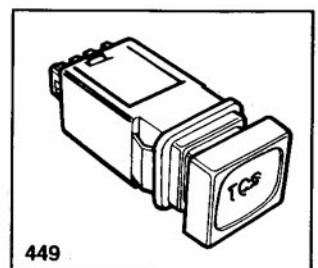
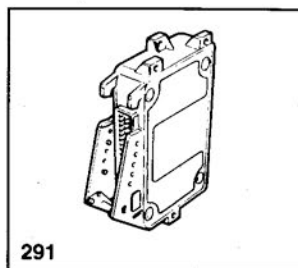
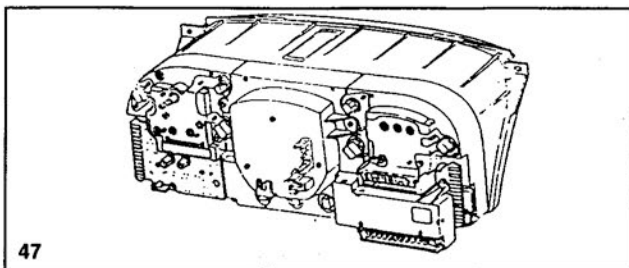
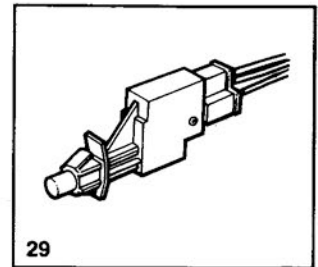
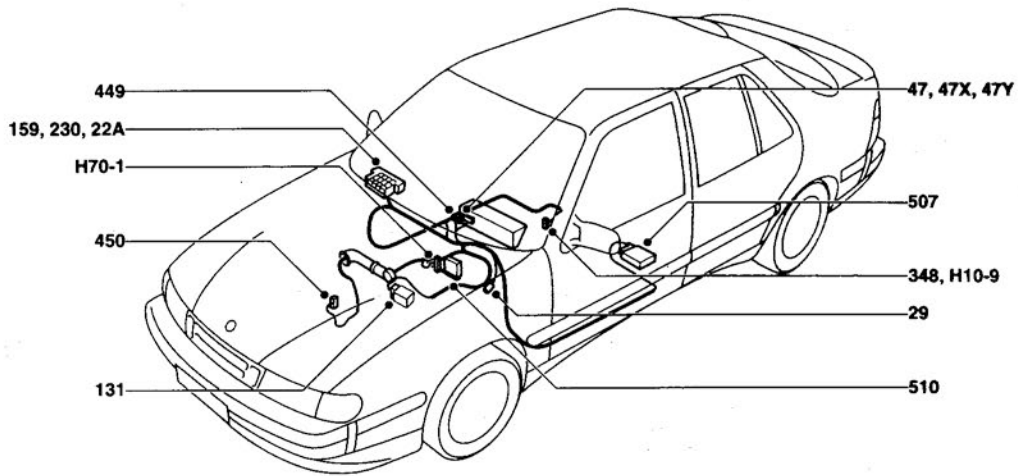

C271W-4571

Headlamps

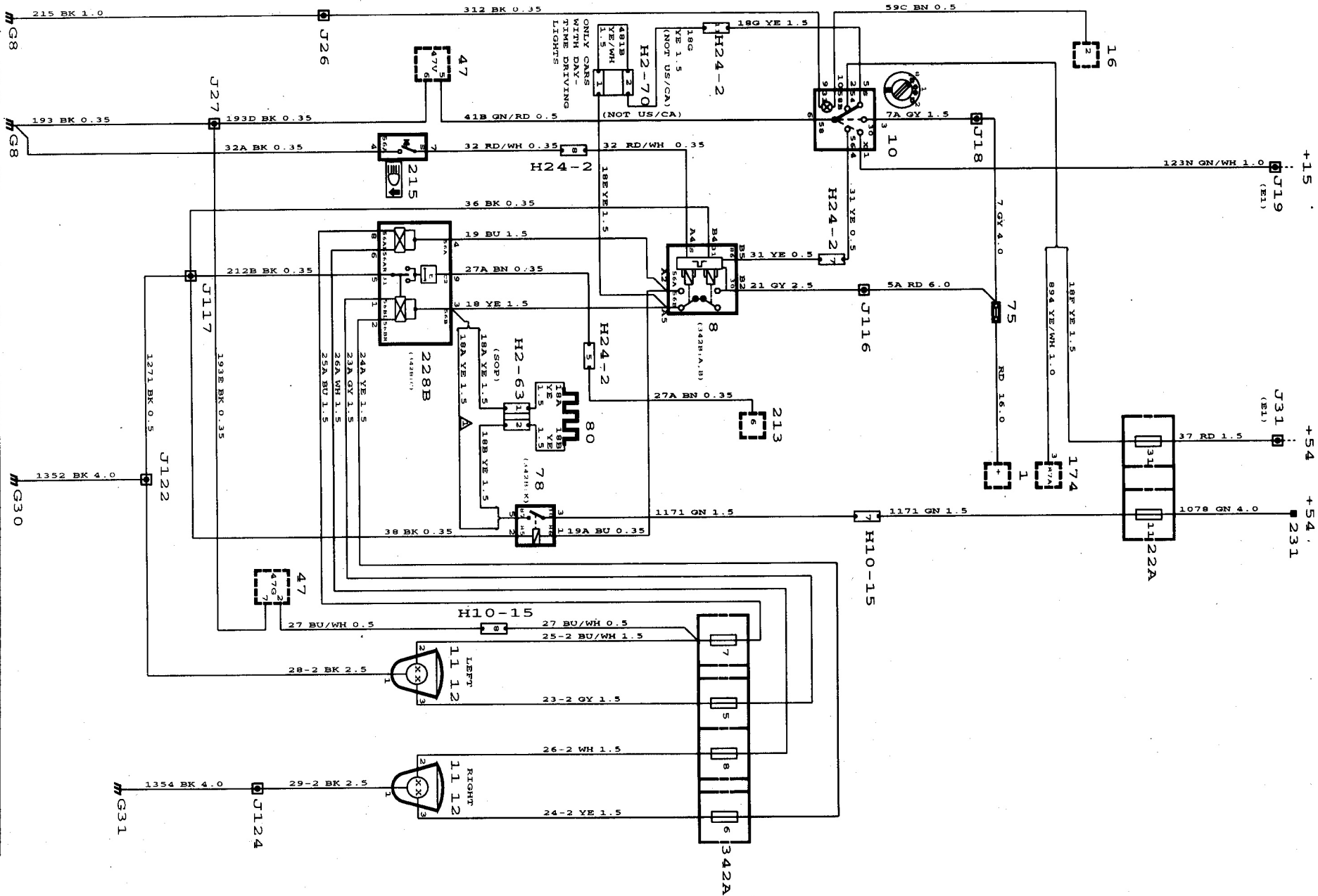

Description of operation

When the headlamps are switched on, the parking lights, which also include the rear lights and number plate lighting, will also light up. The parking lights are dealt with in a separate section.

Full beam

Ignition switch 20 must be in the Drive position before full beams can be switched on. Current will then be supplied to light switch 10, connection X. Dip-switch 215 is spring-loaded.

When light switch 10 is in position 2, lighting relay 8 receives operating current from connection 56 of the light switch. The "upper" coil in lighting relay 8 is energized and contact is made between connections 30 and 56b in the relay.

Pressing dipswitch 215 once energizes the "lower" coil and contact is made between connections 30 and 56a of lighting relay 8.

Current is then supplied via lighting relay 8, connection 56a, to full beam lamps 11, via filament monitor 228B and fuses 7 and 8 (current for full beam indicator lamp 47G is also supplied via fuse 7).

When full beams are on, dipped beams will also be on at reduced intensity. (This function has been discontinued during the model year.) Current is then supplied via connection 56a of lighting relay 8 to the coil of relay 78, which is then energized. Current is supplied via fuse 11 and the relay contacts through resistor 80 to dipped beam lamps 12 via filament monitor 228B and fuses 5 and 6.

When full beams are switched on, current for the parking lights is taken from light switch position 2 via pin 58.

Headlamp flasher

Full beam can also be activated irrespective of the position of the ignition switch and light switch by holding dipswitch 215 depressed. Both relay coils in lighting relay 8 are then energized and current is supplied to the full beam lamps via filament monitor 228B and fuses 7 and 8.

Dipped beam

When light switch 10 is in position 2, lighting relay 8 receives operating current from connection 56 of the light switch. The "upper" coil of lighting relay 8 is energized and contact is made between connections 30 and 56b of the relay.

Current is then supplied via connection 56b of lighting relay 8 to dipped beam lamps 12 via filament monitor 228B and fuses 5 and 6.

When dipped beams are switched on, current for the parking lights is supplied via light switch connection 58.

Filament monitor

If one of the full or dipped beam lamps breaks, the relay in the filament monitor will operate and connection C2 will be grounded. Since connection 5 on pictogram 213 receives positive voltage, the indicator lamps for front lighting and the central warning lamp will light up, see section **Pictogram-Filament monitor**, page 241.

Lights-on indicator lamp

Cars for certain markets have an indicator lamp (47V) which shows when the headlamps are switched on. The indicator lamp is supplied with current via connection 58 of light switch 10.

Fault diagnosis hints

The headlamp is activated when ignition switch 20 is in the Drive position and when light switch 10 is in position 2.

- 1 Check that fuses 7 and 8 (full beam), and 5 and 6 (dipped beam) are intact and supplied with current.
- 2 Check that the lamps are intact and supplied with current.
- 3 Check the grounding of each lamp.
- 4 Check the light switch, the lighting relay, the dip-switch connections and filament monitor connections.
- 5 Check the operation of relay 78 and resistor 80 by taking readings on the connections.
- 6 Check the connectors, wiring harness and ground connections.

For fault diagnosis on the parking lights, see the **Parking lights** section on page 121.

Important:

When changing the bulbs, make sure that the new bulbs are of the correct rating. Otherwise, the lamps in the pictogram may light up due to imbalance in the filament monitor coil.

Component locations

1	Battery in the engine bay.		
8	Lighting relay, in main fuse box in front of the battery.	H2-63	By the left-hand structural member, beside the resistor (80) for dimmed dipped beams (CS).
10	Lights switch on dashboard between steering wheel and driver's door.	H2-70	Beside the wiring harness, under front main fuse box 342.
11	Full beam in LH and RH headlamps.		<i>10-pin connector</i>
12	Dipped beam in LH and RH headlamps.	H10-15	Behind the left-hand headlamp.
16	Rheostat, lighting for controls, on dashboard between steering wheel and driver's door.	H24-2	Behind the left-hand headlamp.
22A	Fuse board, behind the cover flap in the glove box.	G8	Grounding point, dashboard, by the left-hand front loudspeaker socket.
	<i>in the main instrument display panel</i>	G30	Grounding point, left-hand structural member, behind the left-hand headlamp.
47G	Full beam indicator lamp	G31	Grounding point, on the right-hand structural member, behind the right-hand headlamp.
47V	Lights-on indicator lamp		
75	Distribution block, battery positive, on the battery tray.		
78	Relay, dimmed lights, in main fuse box in front of the battery.		
80	Resistor, dimmed lights, on left-hand structural member.		
213	Pictogram, in the main instrument display panel.		
215	Dipswitch, on the left-hand side of the steering column.		
228B	Filament monitor, front lamps, in main fuse box in front of the battery.		
231	Distribution terminal (+54 circuit), in main fuse box behind the glove box.		
342A	Fuse board, in main fuse box in front of the battery.		

Components

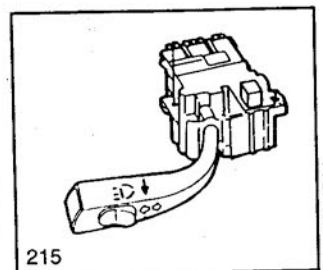
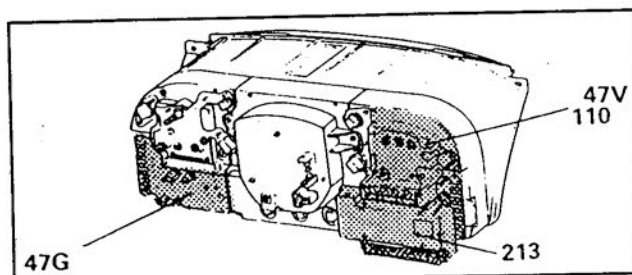
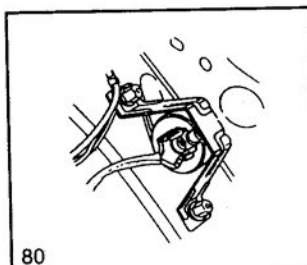
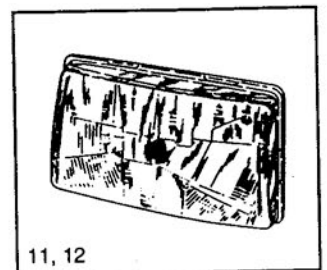
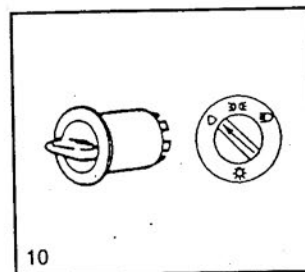
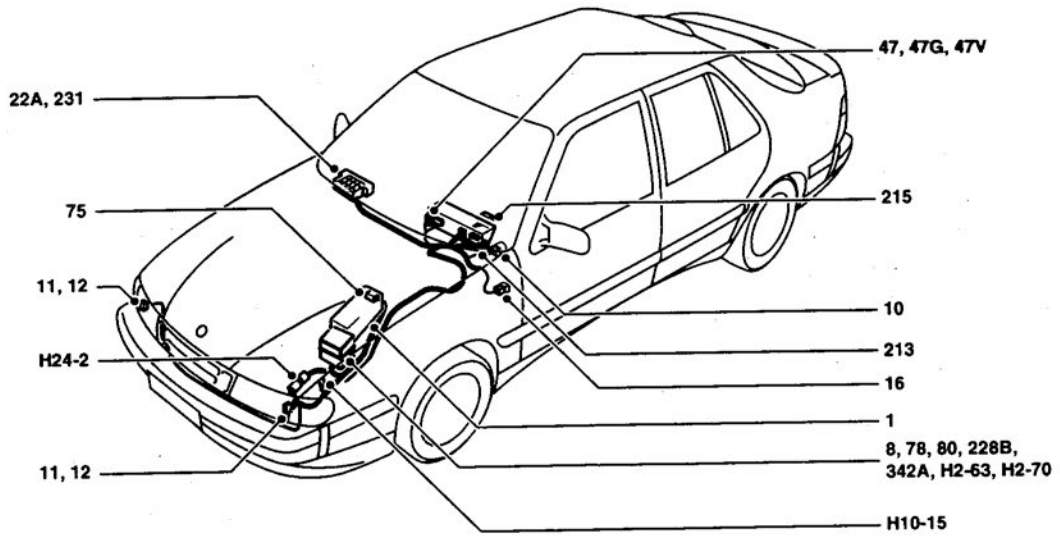

C351W-4514

Daylight driving lights US, CA

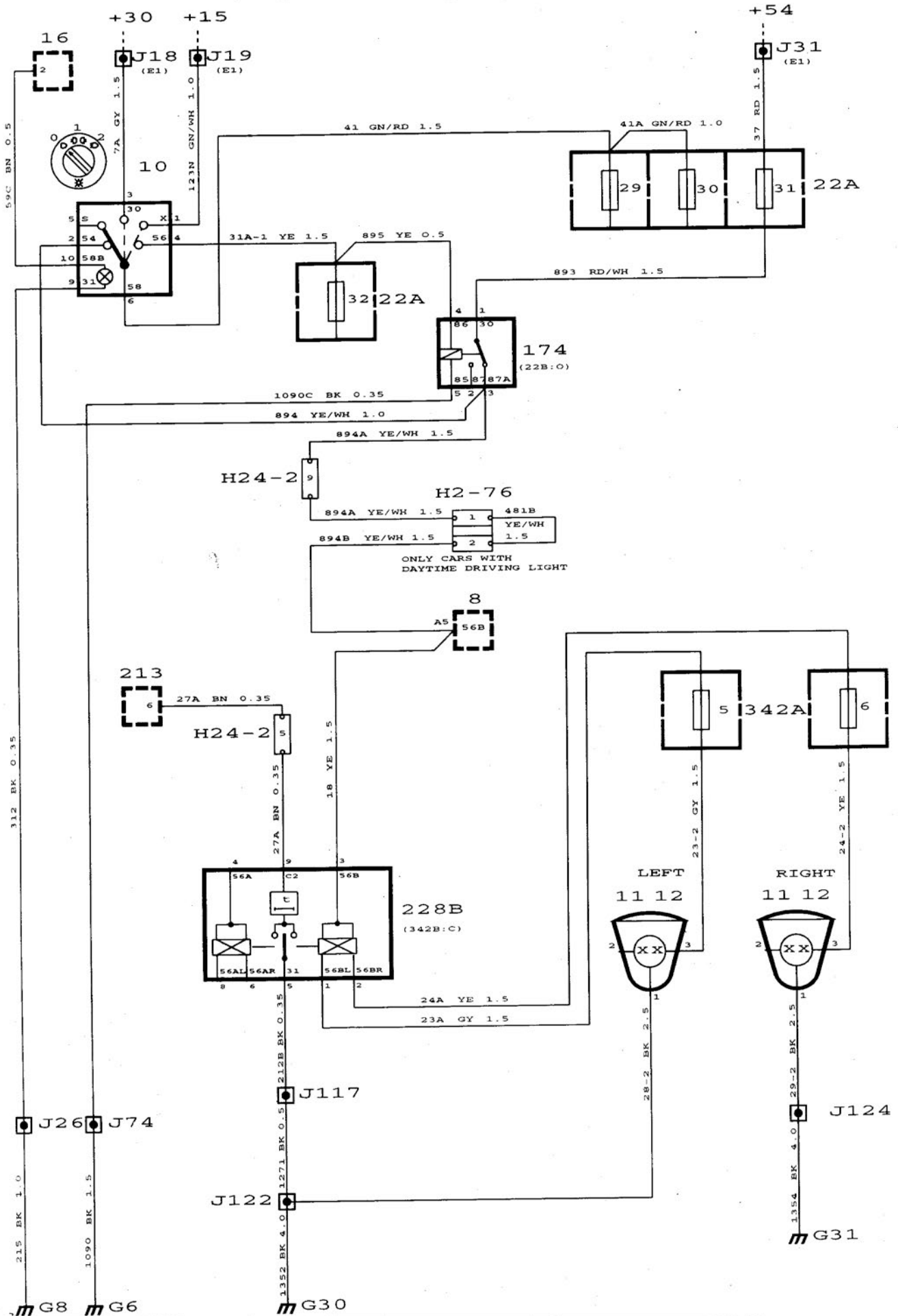

Description of operation

In the US and CA markets, dipped beams function as daylight driving lights. The lights go on when the ignition switch is in the Drive position. The car's parking lights, rear lights, number plate lighting and side marker lights also go on.

When ignition switch 20 is in the Drive position and light switch 10 is in position 0 or 1, current is supplied from relay 174, connection 87A, to dipped beam lamps 12 via filament monitor 228B and fuses 5 and 6.

When the light switch is in position 2, relay 174 receives operating current from connection 56 of the light switch. The relay operates and the daylight driving lights are disconnected to avoid reverse currents.

Filament monitor

If any of the full or dipped beam lamps breaks, the dipped beam relay in the filament monitor operates and connection C2 is grounded. Since connection 9 of pictogram 213 receives positive voltage (from the ignition switch), the indicator lamps for lighting and the central warning lamp light up. See also the section **Pictogram-Filament monitor**, page 241.

Fault diagnosis hints

The daylight driving lights are activated when ignition switch 20 is in the Drive position and light switch 10 is in position 0 or 1.

- 1 Check that fuses 5 and 6 (dipped beam) are intact and supplied with current.
- 2 Check that the lamps are intact and supplied with current. Check the grounding.
- 3 Check the light switch, relay 174 and the filament monitor connections.
- 4 Check the connectors, wiring harness and ground connections.

Important:

When changing the bulbs, make sure that the new bulbs are of the correct rating. Otherwise, the lamps in the pictogram may light up due to imbalance in the filament monitor coil.

Component locations

8	Lighting relay, in main fuse box in front of the battery.
10	Lights switch, on the dashboard adjacent to the driver's door
11	Full beam in LH and RH head-lamps.
12	Dipped beam in LH and RH head-lamps.
16	Rheostat, lighting for controls, on dashboard between the steering wheel and driver's door.
22A	Fuse board, behind the cover flap in the glove box.
174	Relay, daylight driving lights, in main fuse box behind the glove box.
213	Pictogram, in the main instrument display panel.
228B	Filament monitor, front lamps, in main fuse box in front of the battery.
342A	Fuse board, in main fuse box in front of the battery. <i>2-pin connector</i>
H2-76	On the wiring harness under the front main fuse box. <i>24-pin connector</i>
H24-2	Behind the left-hand headlamp.
G6	Grounding point, negative distribution terminal, in the main fuse box behind the glove box.
G8	Grounding point, dashboard, by the left-hand front loudspeaker socket.
G30	Grounding point, left-hand radiator cross-member, behind the left-hand headlamp.
G31	Grounding point, right-hand radiator cross-member, behind the right-hand headlamp.

Components

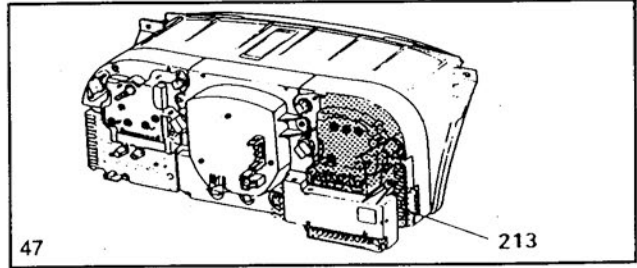
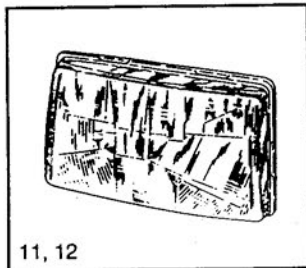
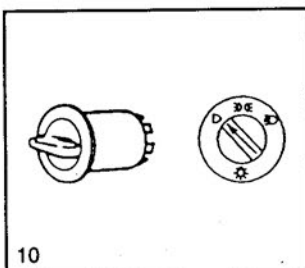
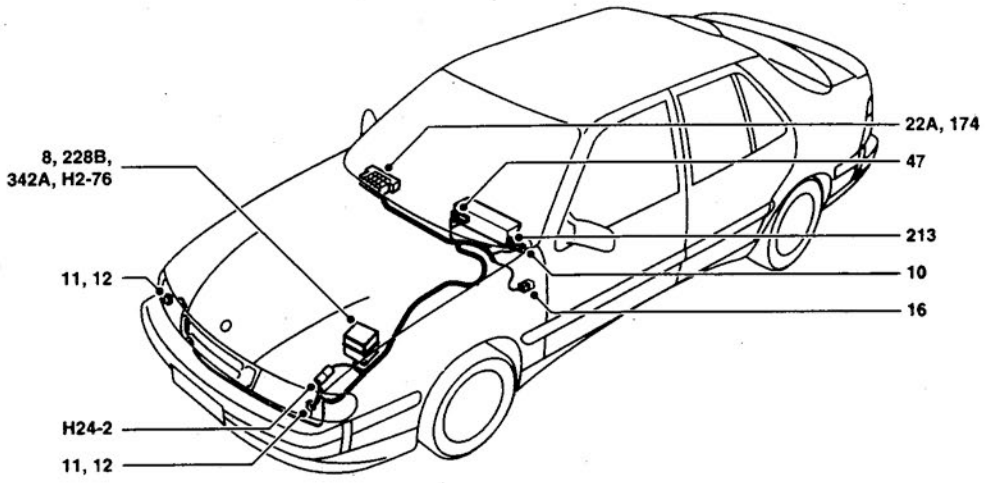

C351W-4515

Daylight driving lights, other markets

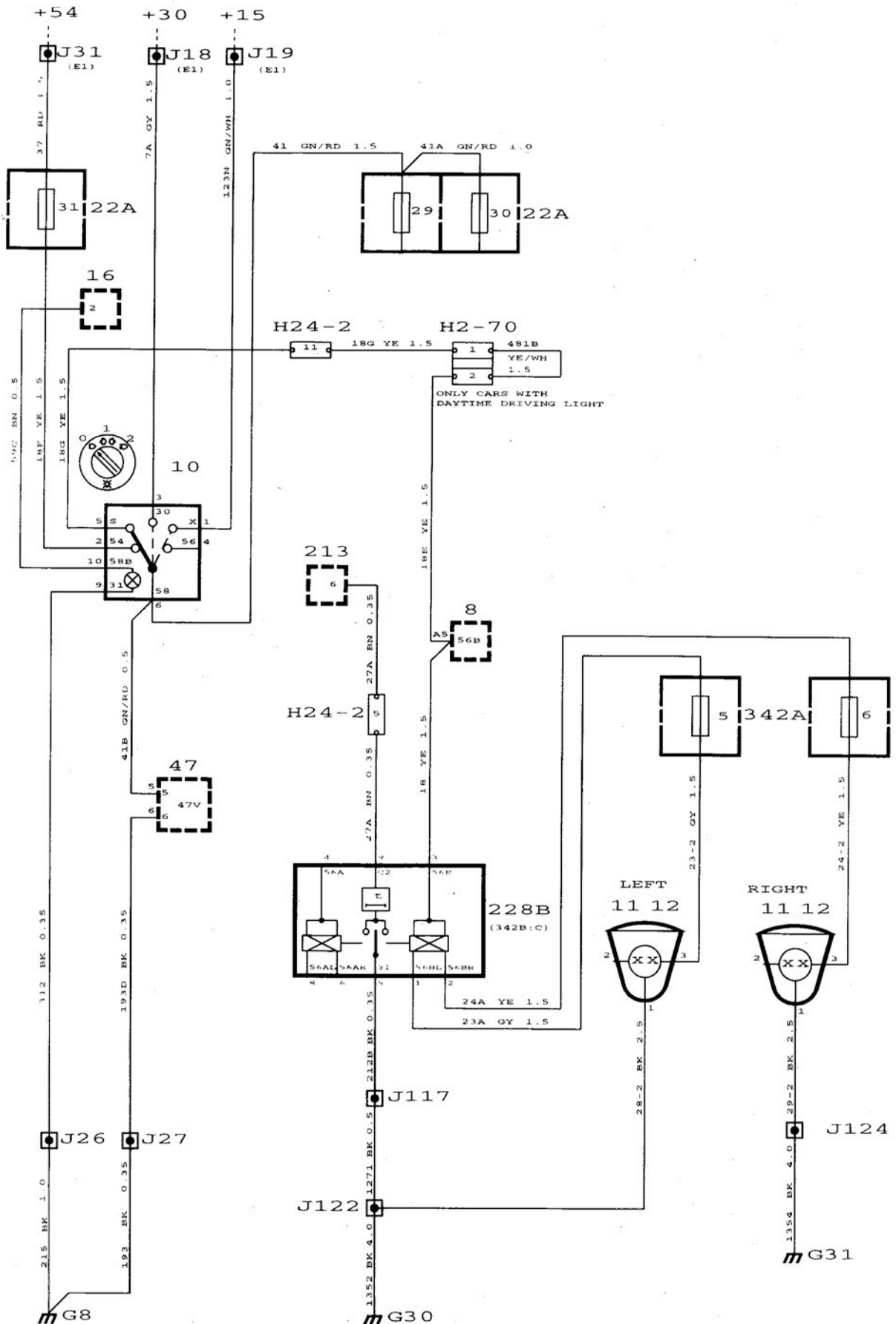

Description of operation

In some of the other markets, dipped beams are used as daylight driving lights. The lamps light up when the ignition switch is turned to the Drive position. The parking lights, rear lights and number plate lighting also light up.

When ignition switch 20 is in the Drive position and light switch 10 is in the 0 position, current is supplied via fuse 31, light switch 10, filament monitor 228B and fuses 5 and 6 to dipped beam lamps 12.

In certain markets an indicator lamp (47V) is also fitted to show when the lights are on.

Filament monitor

If any of the full or dipped beam lamps breaks, the dipped beam relay in the filament monitor operates and connection C2 is grounded. Since connection 9 of pictogram 213 receives positive voltage (from the ignition switch), the indicator lamps for lighting and the central warning lamp light up. See also the section **Pictogram-Filament monitor**, page 241.

Fault diagnosis hints

The daylight driving lights are activated when ignition switch 20 is in the Drive position and light switch 10 is in the 0 position.

- 1 Check that fuses 5 and 6 (dipped beam) are intact and supplied with current.
- 2 Check that the lamps are intact and supplied with current. Check the grounding.
- 3 Check light switch 10, fuse 31 and the filament monitor connections.
- 4 Check the connectors, wiring harness and ground connections.

Important:

When changing the bulbs, make sure that the new bulbs are of the correct rating. Otherwise, the lamps in the pictogram may light up due to imbalance in the filament monitor coil.

Component locations

- 8 Lighting relay, in main fuse box in front of the battery.
- 10 Lights switch on dashboard between steering wheel and driver's door.
- 11 Full beam in LH and RH headlamps.
- 12 Dipped beam in LH and RH headlamps.
- 16 Rheostat, lighting for controls, on dashboard between the steering wheel and driver's door.
- 22A Fuse board behind the cover flap in the glove box.
- 47 Main instrument display panel in the dashboard.
- 47V Lights-on indicator lamp, in the main instrument display panel.
- 213 Pictogram, in the main instrument display panel.
- 228B Filament monitor, front lamps, in main fuse box in front of the battery.
- 342A Fuse board in main fuse box in front of battery.
2-pin connector
- H2-70 Beside the wiring harness under front main fuse box 342.
24-pin connector
- H24-2 Behind the left-hand headlamp.
- G8 Grounding point, dashboard, by the left-hand front loudspeaker socket.
- G30 Grounding point, left-hand structural member behind the left-hand headlamp.
- G31 Grounding point, right-hand structural member behind the right-hand headlamp.

Components

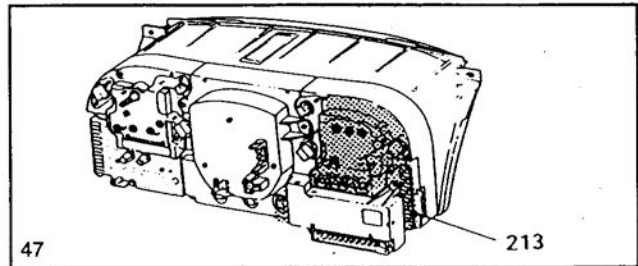
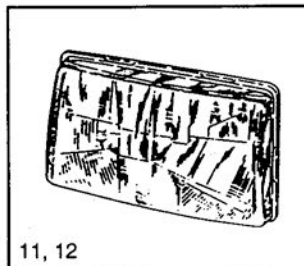
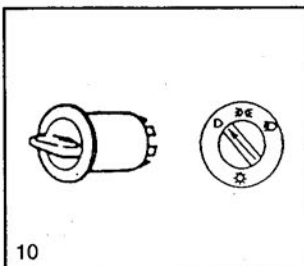
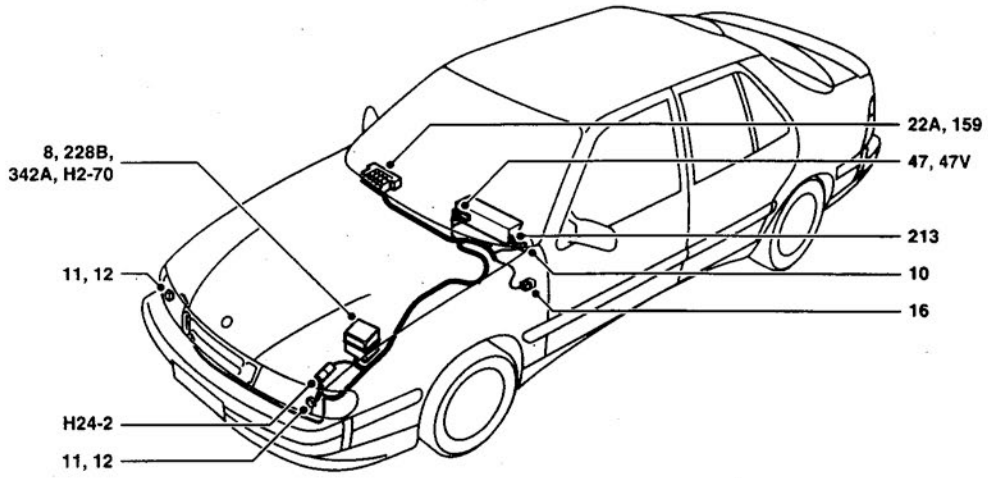

C351W-4516

Parking lights with/without side marker lights

(SOP) This wiring diagram has been superseded during the model year by the schematic on the next page.

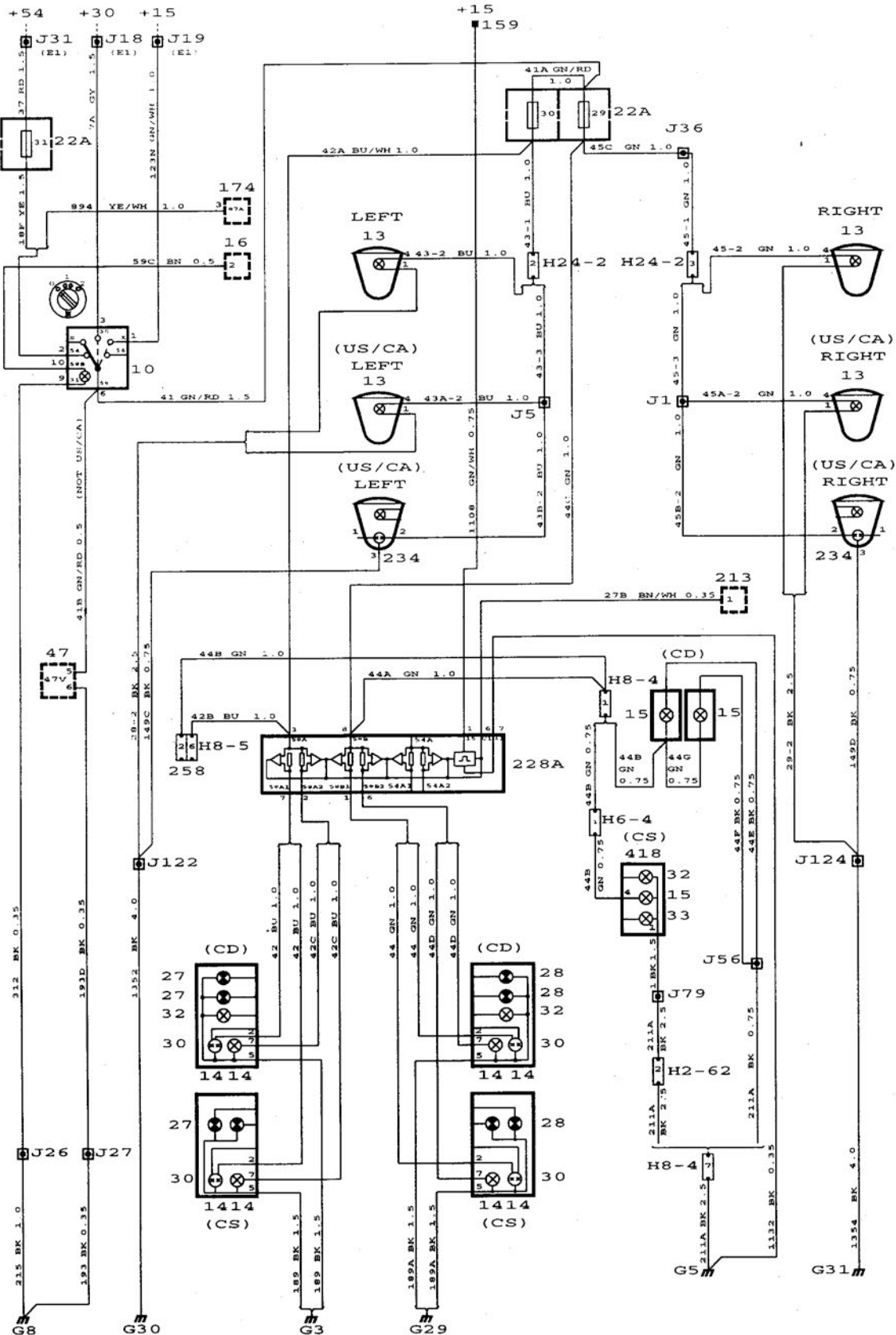

Description of operation

The parking lights are switched on and off by means of lights switch 10 which is always supplied with current, see the section "Power supply (+30 circuit)" on page 43.

When the lights switch is in position 1, current is supplied to parking lights 13 via fuses 29 and 30.

Both rear lights 14 are also supplied with current from these fuses, but via filament monitor 228A.

If any of the rear light bulbs fails, connection C1 will be grounded. Since connection 9 on pictogram 213 receives positive voltage (from the ignition switch), the indicator lamps for rear lights and the central warning lamp will light up. See the section **Pictogram-Filament monitor**, on page 241.

Number plate lighting 15 and the parking lights on a trailer are always supplied with current when the parking lights are on. However, this current supply does not go via the filament monitor.

The parking lights on a trailer are supplied with current via connector 258 (H8-5).

Side marker lights 234 are fitted on cars for certain markets.

In certain markets an indicator lamp (47V) is also fitted to show when the lights are on.

Fault diagnosis hints

The parking lights are switched on by turning lights switch 10 to position 1.

- 1 Check that fuses 29 and 30 are intact and supplied with current.
- 2 Check that the bulbs are intact and supplied with current. Check the grounding of each lamp.
- 3 Check that switch 10 and filament monitor 228A are in working order by taking readings on each connection.
- 4 Check the connectors, wiring harness and ground connections.

Important:

When changing the bulbs, make sure that the new bulbs are of the correct rating. Otherwise, the lamps in the pictogram may light up due to imbalance in the filament monitor coil.

Component locations

10	Lights switch on dashboard between steering wheel and driver's door.	H2-62	<i>2-pin connector</i> In the tailgate on the left-hand side.
13	Parking lights in the front light cluster.		<i>6-pin connector</i>
14	Rear lights in the rear light cluster.	H6-4	In the tailgate on the left-hand side beside the rear window.
15	Number plate lighting on the tailgate.		<i>8-pin connector</i>
16	Rheostat, lighting for controls, on dashboard between the steering wheel and driver's door.	H8-4	By the left-hand rear wheel housing.
22A	Fuse board behind the cover flap in the glove box.	H24-2	<i>24-pin connector</i> Behind the left-hand headlamp.
27	Direction indicator lamps, left-hand side, in front and rear light clusters.	G3	Grounding point, luggage compartment, on the left-hand side by the left-hand rear light cluster.
28	Direction indicator lamps, right-hand side, in front and rear light clusters.	G5	Grounding point, rear seat, on left-hand side.
30	Brake lights in rear light clusters.	G8	Grounding point, dashboard, by the left-hand front loudspeaker socket.
32	Rear light bulbs CD: in rear light clusters. CS: in tailgate light fitting.	G29	Grounding point, luggage compartment, on the right-hand side by the right-hand rear light cluster.
33	Rear fog light CD: in rear light cluster. CS: In tailgate light fitting.	G30	Grounding point, left-hand structural member behind the left-hand headlamp.
47	Main instrument display panel in the dashboard.	G31	Grounding point, right-hand structural member behind the right-hand headlamp.
47V	Lights-on indicator lamp in the main instrument display panel.		
159	Distribution terminal (+15 circuit) in main fuse box behind the glove box.		
213	Pictogram in the main instrument display panel.		
228A	Filament monitor, rear lamps, in the luggage compartment on the left-hand side.		
234	Side marker lights in the front light clusters.		
258 (H8-5)	Connection for trailer lighting, in luggage compartment on the left below the light cluster.		
418	Rear light fitting, CS, in the tailgate.		

Components

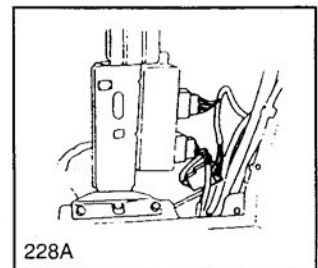
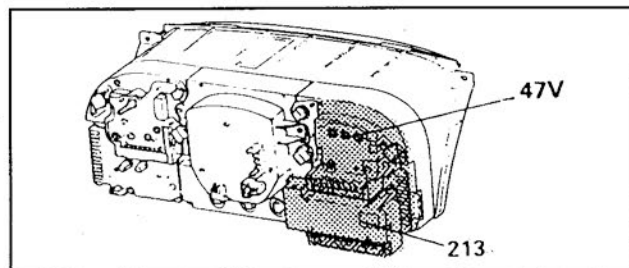
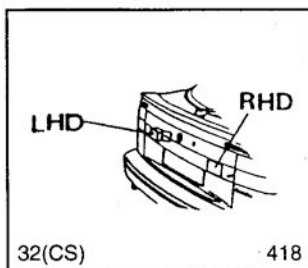
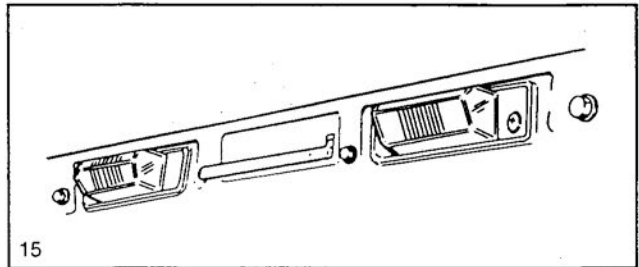
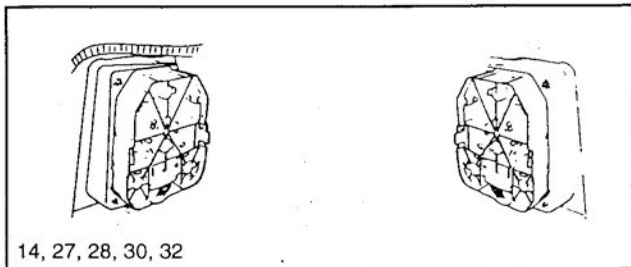
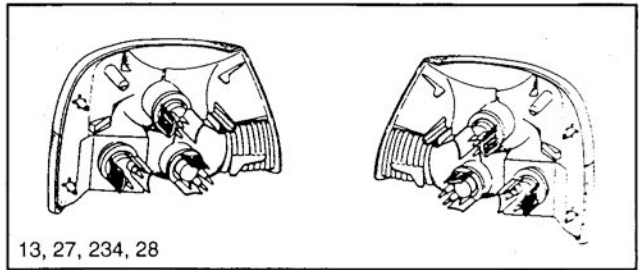
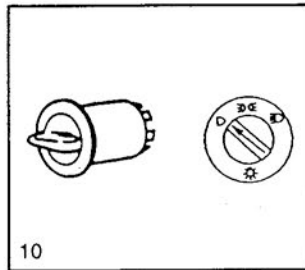
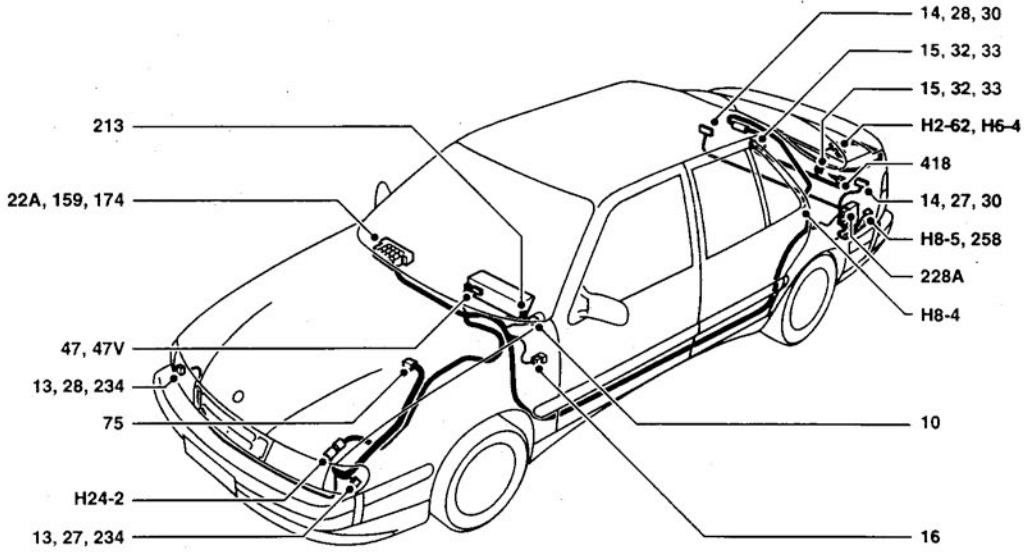

C351W-4517

Extra fog lights US, CA

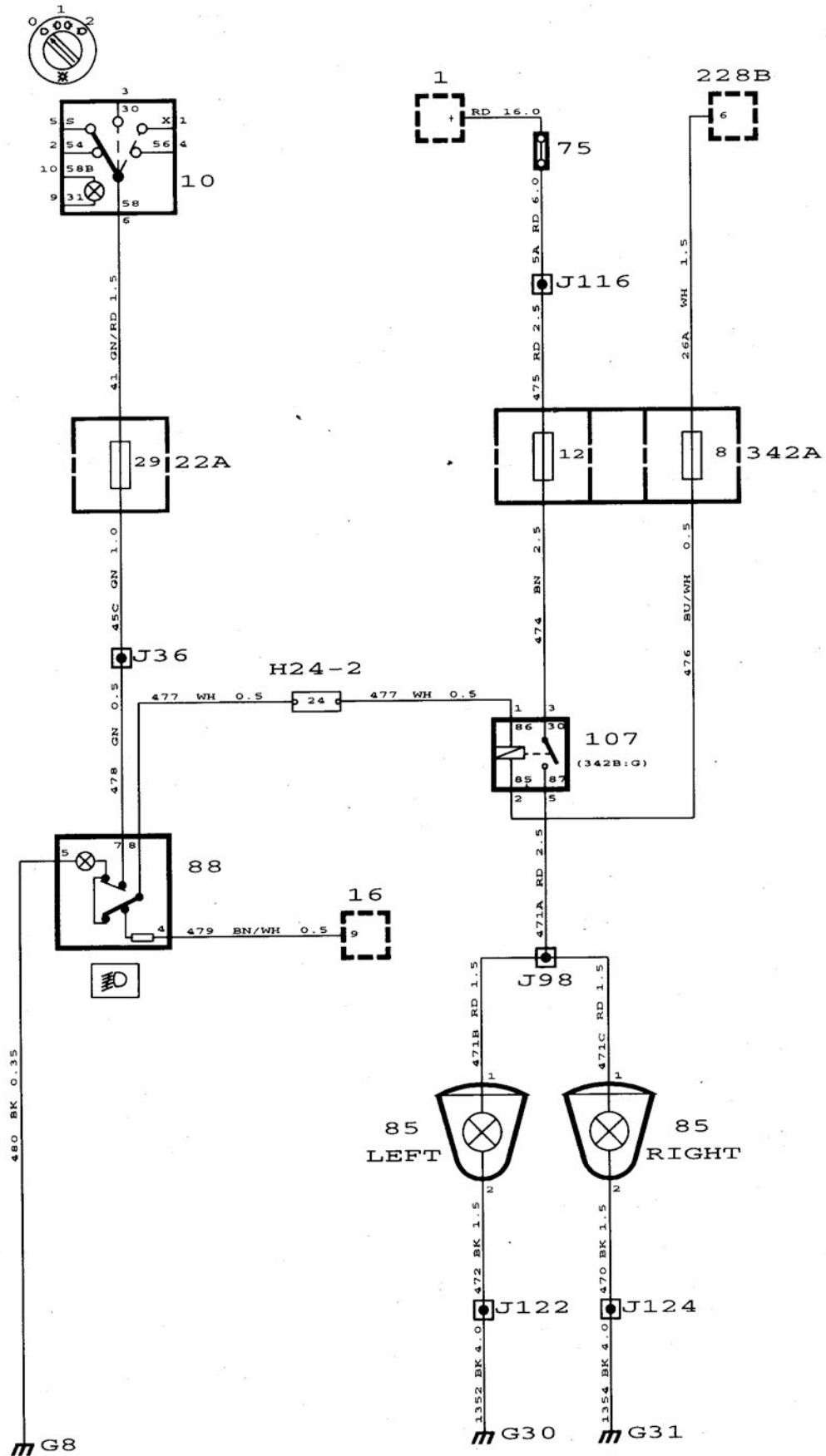

Extra fog lights, other markets

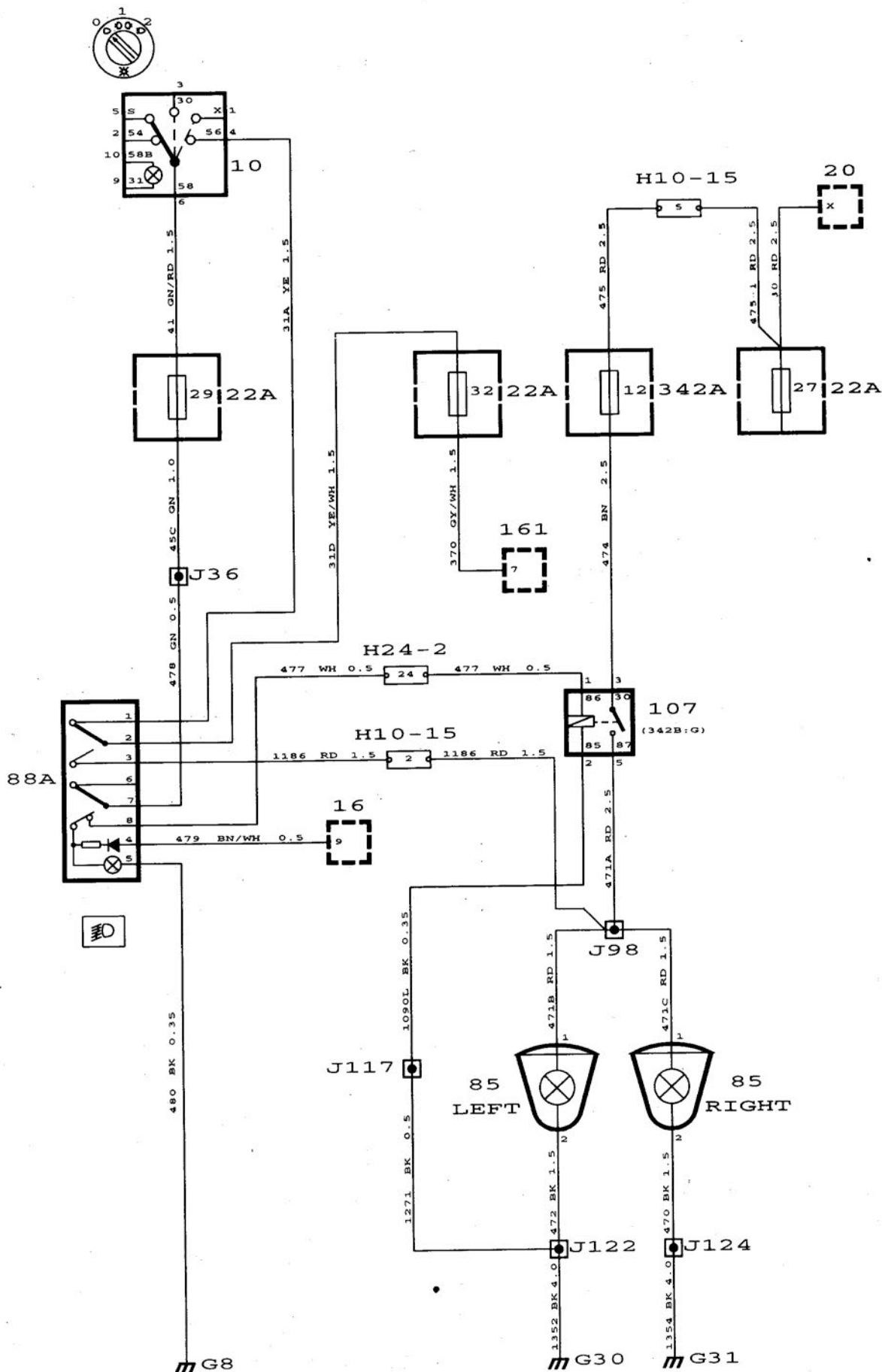

Description of operation

US and CA markets

If the car's full beam is lit, relay 107 will deactivate and the fog lights will go out, even if switch 88 is depressed. This is because both sides of the relay coil receive positive voltage.

Daylight driving light relay 174 supplies positive voltage to the fog lights when the light switch is in position 0.

Other markets

The fog lights are wired so that they can be lit when the car's daylight driving lights, parking lights, full beam or dipped beam are on.

If light switch 10 is in position 0 (daylight driving lights), position 1 (parking lights) or position 2 (full or dipped beam), switch 88, connection 7, for extra fog lights receives positive voltage via pin 29. This also feeds the parking lights.

When switch 88A is depressed, relay 107 operates and the lamp built into the switch lights up at full intensity. When the switch is not activated, the lamp is supplied with current via rheostat 16 (lighting for controls).

When the relay is energized, both fog lights 85 receive current from fuse 12 via the closed relay contact.

On cars with extra fog lights and a rear fog light, the rear fog light is supplied with current via relay 107 and extra fog light switch 88 when the extra fog lights are switched on.

Fault diagnosis hints

The extra fog lights are switched on by pressing switch 88.

- 1 Check that fuses 8, 12 and 29 are intact and supplied with current.
- 2 Check that each fog light bulb is OK and supplied with current.
- 3 Check the grounding at the lamp.
- 4 Check the operation of relay 107, lights switch 10 and switch 88/88A by taking readings on their connections.
- 5 Check the wiring harness, connectors and ground connections.

US and CA markets

Also check:

- 6 That the full beam bulbs are intact. (Relay 107 is grounded via the lamps.)
- 7 That fuse 8 is intact. If the fuse has blown, the fog lights will not go out when full beams are switched on.

Component locations

1	Battery in the engine bay.
10	Lights switch on dashboard between steering wheel and driver's door.
16	Rheostat, lighting for controls, on dashboard between the steering wheel and driver's door.
22A	Fuse board behind the cover flap in the glove box.
75	Distribution block, battery positive, on the battery tray.
85	Extra fog lights in front spoiler.
88/88A	Switch, extra fog lights, on dashboard between the steering wheel and driver's door.
107	Relay, extra fog lights, in main fuse box in front of the battery.
161	Switch, rear fog light, on dashboard between the steering wheel and driver's door.
342A	Fuse board in main fuse box in front of battery. <i>10-pin connector</i>
H10-15	Behind the left-hand headlamp. <i>24-pin connector</i>
H24-2	Behind the left-hand headlamp.
G8	Grounding point, dashboard, by the left-hand front loudspeaker socket.
G30	Grounding point, left-hand structural member behind the left-hand headlamp.
G31	Grounding point, right-hand structural member behind the right-hand headlamp.

Components

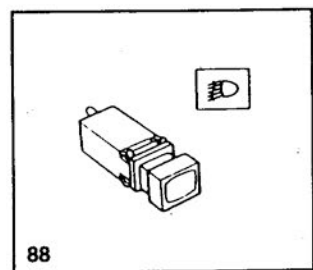
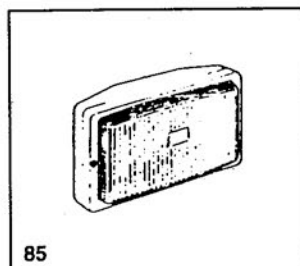
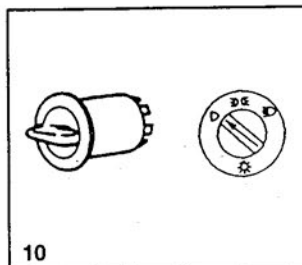
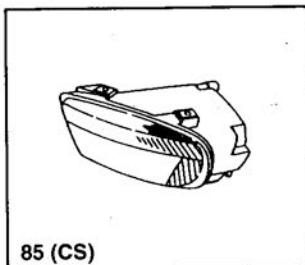
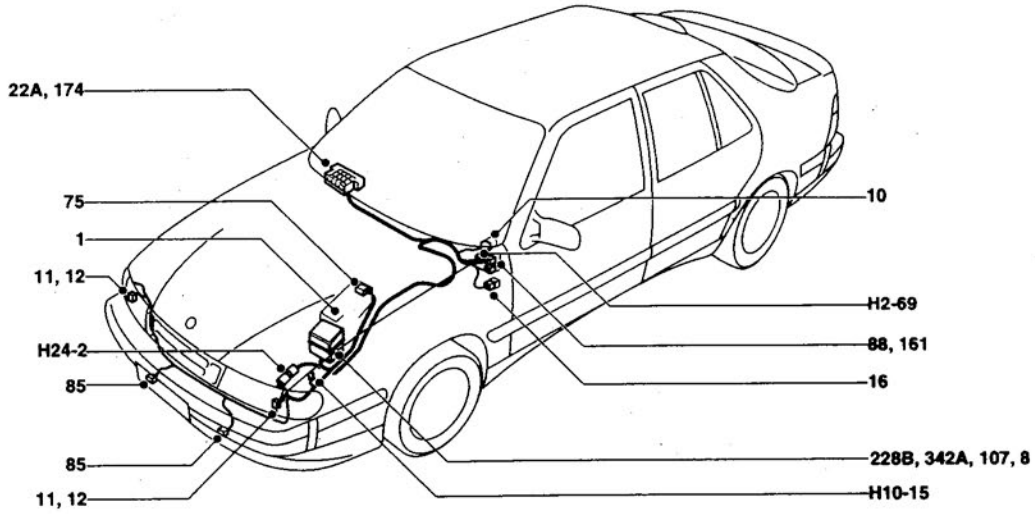

C351W-4518

Brakes lights with reset memory

(SOP) This wiring diagram has been superseded during the model year by the schematic on page 137.

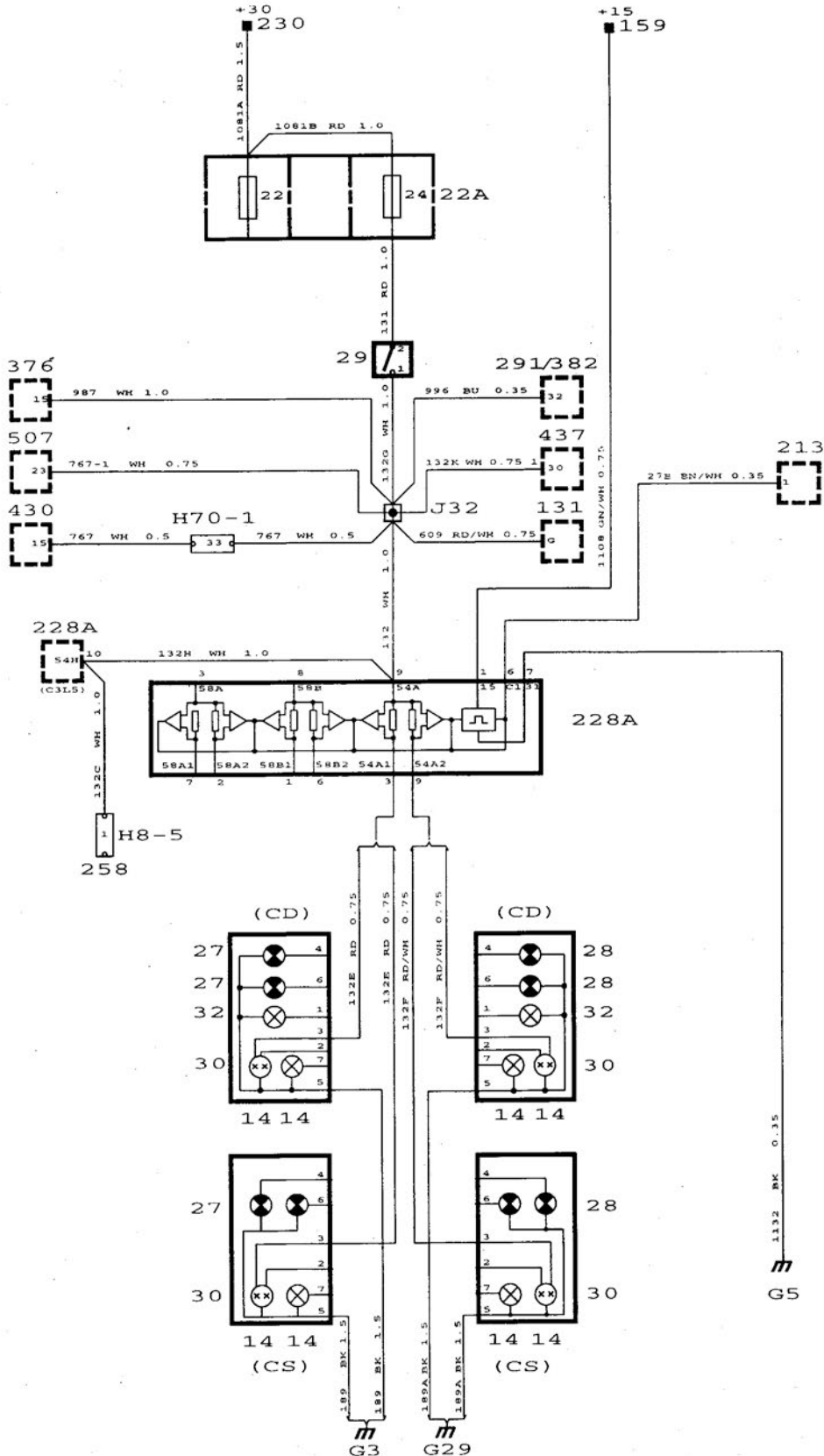

Description of operation

Voltage is fed from fuse 24 to brake light switch 29. When the switch is activated, brake lights 30 receive voltage via filament monitor 228A.

Brake lights on a trailer are fed directly from the brake light switch via towbar connector 258.

If any brake light bulb fails, connection C1 will be grounded. Since connection 9 on the pictogram receives positive voltage, the indicator lamps for rear lights and the central warning lamp will light up. See also the section **Pictogram-Filament monitor** on page 241.

With reset memory

In certain markets the filament monitor is supplemented with a circuit for monitoring brake light switch 29. This additional circuit is supplied with current via the terminal block for the +15 circuit.

If in proper working order, the pictogram's warning lamp for rear lights should light up when the ignition is switched on and stay on until the brake pedal is depressed.

Fault diagnosis hints

- 1 Check that fuse 24 is intact and supplied with current.
- 2 Check that brake light switch 29 is supplied with current.
- 3 Activate the brake light switch. Check that the bulbs are OK and supplied with current and also check the ground connection of each lamp.
- 4 Check the filament monitor.
- 5 Check the connectors, wiring harness and ground connections.

Important:

When changing the bulbs, make sure that the new bulbs are of the correct rating. Otherwise, the lamps in the pictogram may light up due to imbalance in the filament monitor coil.

Component locations

- 14 Rear lights in the rear light clusters.
- 22A Fuse board behind the cover flap in the glove box.
- 27 Direction indicator lamps, left-hand side, in front and rear light clusters.
- 28 Direction indicator lamps, right-hand side, in front and rear light clusters.
- 29 Brake light switch beside the brake pedal.
- 30 Brake lights in rear light clusters.
- 32 Rear lights
CD: in rear light clusters.
CS: in tailgate light fitting.
- 159 Distribution terminal (+15 circuit) in main fuse box behind the glove box.
- 213 Pictogram in the main instrument display panel.
- 228A Filament monitor, rear lamps, in luggage compartment on the left-hand side.
- 230 Distribution terminal (+30 circuit) in main fuse box behind the glove box.
- 258 (H8-5) Connection for trailer lighting, in luggage compartment below the left-hand light cluster.
- G3 Grounding point, luggage compartment, on the left-hand side by the left-hand rear light cluster.
- G5 Grounding point, rear seat, on left-hand side.
- G29 Grounding point, luggage compartment, on the right-hand side by the right-hand rear light cluster.

Components

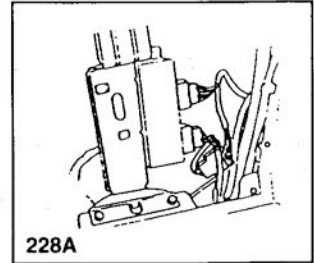
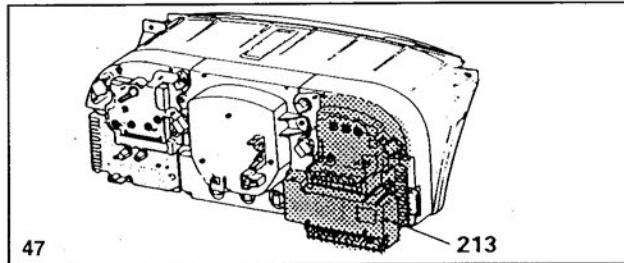
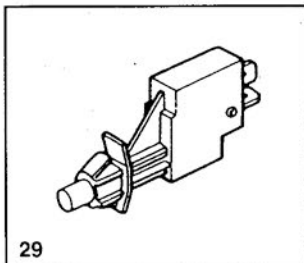
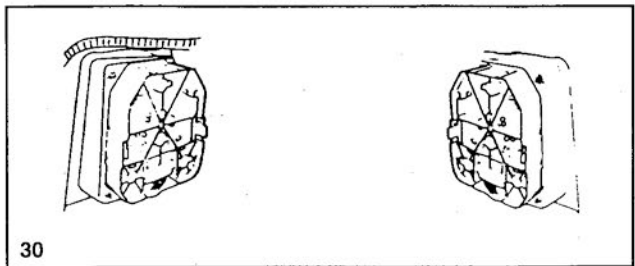
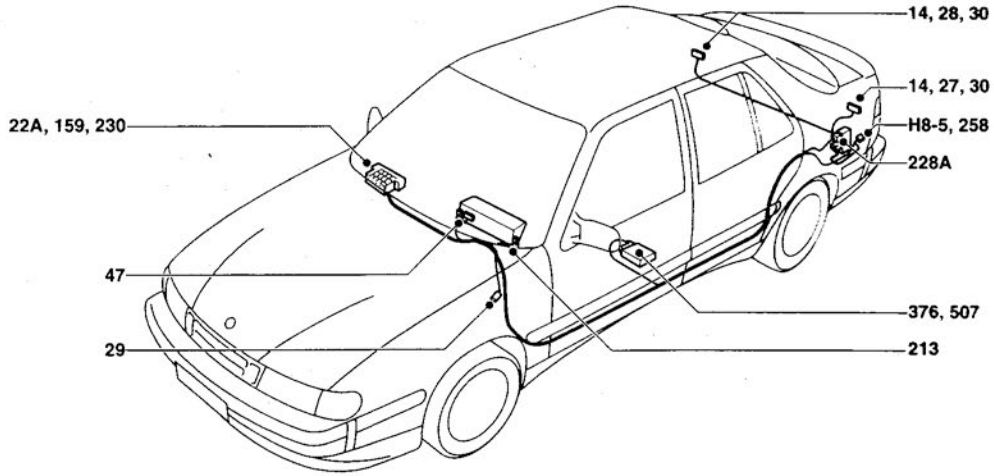

C351W-4519

Brake lights with high-level brake light

(SOP) This wiring diagram has been superseded during the model year by the schematic on the next page.

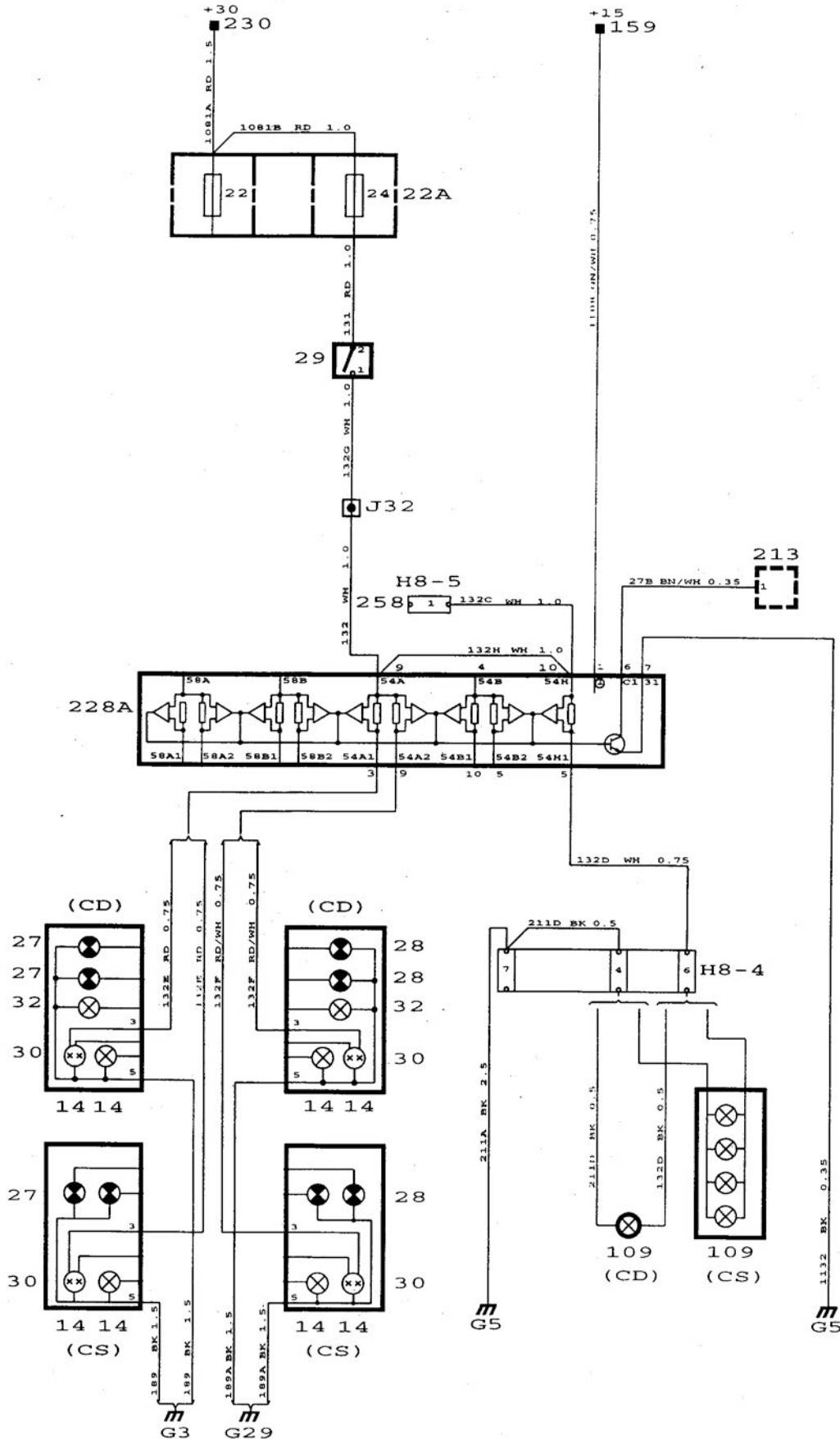

Brake lights with high-level brake light and reset memory

This system has been introduced on all cars during the model year.

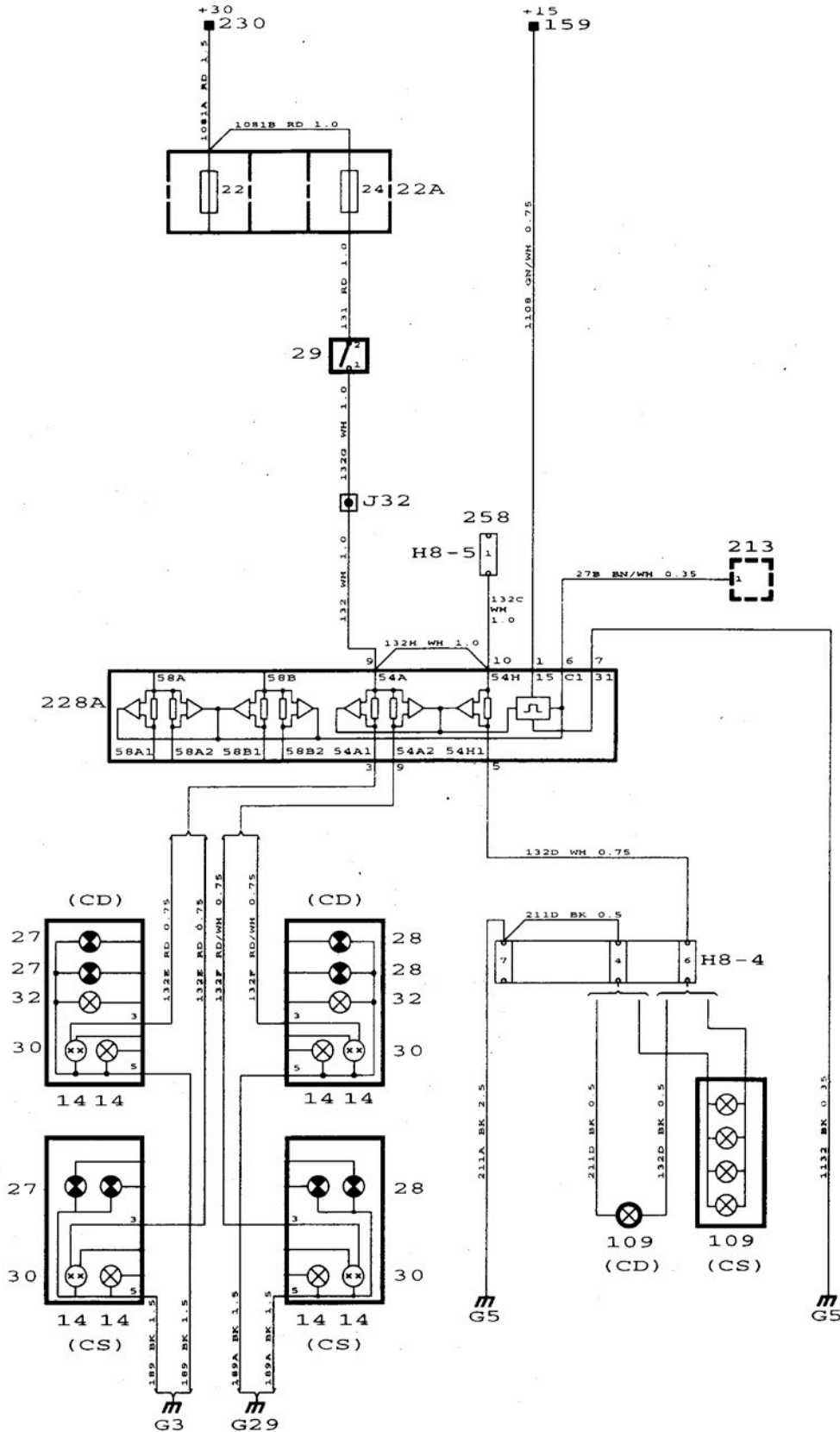

Description of operation

Voltage is fed from fuse 24 to brake light switch 29. When the switch is activated, brake lights 30 receive voltage via filament monitor 228A.

Brake lights on a trailer are fed directly from the brake light switch via towbar connector 258.

If any brake light bulb fails, connection C1 will be grounded in the filament monitor. Since connection 9 on the pictogram receives positive voltage, the indicator lamps for rear lights and the central warning lamp will light up. See also the section **Pictogram-Filament monitor** on page 241.

High-level brake light

On cars with a high-level brake light, the filament monitor has an extra circuit for monitoring brake light 109. (The high-level brake light on CS models has 4 bulbs. In order for the pictogram to light up, at least 2 bulbs must in most cases be defective.)

If the bulb (or in the case of CS models, the bulbs) fails, connection C1 is grounded and the rear lighting and central warning lamps in the pictogram light up.

In certain markets the high-level brake light is not permitted.

Cable 132D is available in all markets so that a high-level brake light can be fitted if the relay is changed for one with a logic circuit for the high-level brake light.

Reset memory

The filament monitor contains a circuit for monitoring brake light switch 29. This circuit is supplied with current via the terminal block for the +15 circuit.

If in proper working order, the pictogram's warning lamp for rear lights should light up when the ignition is switched on and stay on until the brake pedal is depressed.

Fault diagnosis hints

- 1 Check that fuse 24 is intact and supplied with current.
- 2 Check that brake light switch 29 is supplied with current.
- 3 Activate the brake light switch. Check that the bulbs are OK and supplied with current and also check the ground connection of each lamp.
- 4 Check the filament monitor.
- 5 Check the connectors, wiring harness and ground connections.

Important:

When changing the bulbs, make sure that the new bulbs are of the correct rating. Otherwise, the lamps in the pictogram may light up due to imbalance in the filament monitor coil.

Component locations

- 14 Rear lights in the rear light clusters.
- 22A Fuse board behind the cover flap in the glove box.
- 27 Direction indicator lamps, left-hand side, in front and rear light clusters.
- 28 Direction indicator lamps, right-hand side, in front and rear light clusters.
- 29 Brake light switch beside the brake pedal.
- 30 Brake lights in rear light clusters.
- 32 Rear lights
CD: in rear light clusters.
CS: in tailgate light fitting.
- 109 High-level brake light
CD: in rear window.
CS: in tailgate.
- 159 Distribution terminal (+15 circuit) in main fuse box behind the glove box.
- 213 Pictogram in the main instrument display panel.
- 228A Filament monitor, rear lamps, in luggage compartment on the left-hand side.
- 230 Distribution terminal (+30 circuit) in main fuse box behind the glove box.
- 258 (H8-5) Connection for trailer lighting, in luggage compartment below the left-hand light cluster.
8-pin connector
- H8-4 By the left-hand rear wheel housing.
- G3 Grounding point, luggage compartment, on the left-hand side by the left-hand rear light cluster.
- G5 Grounding point, rear seat, on left-hand side.
- G29 Grounding point, luggage compartment, on the right-hand side by the right-hand rear light cluster.

Components

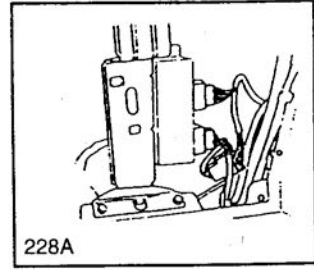
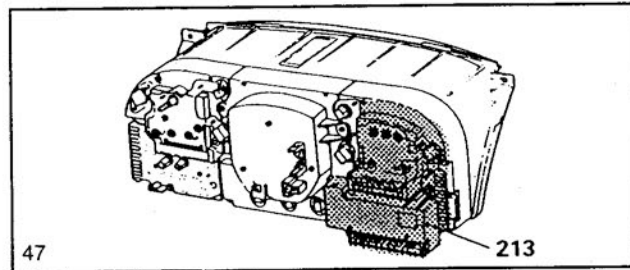
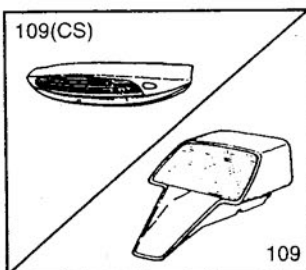
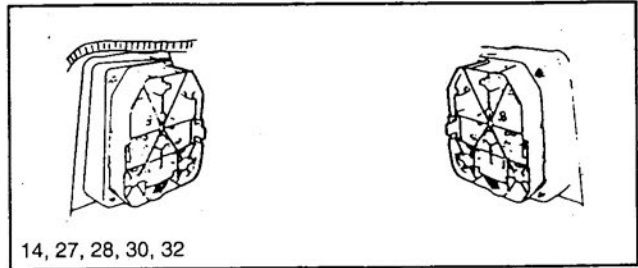
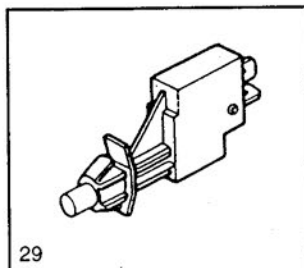
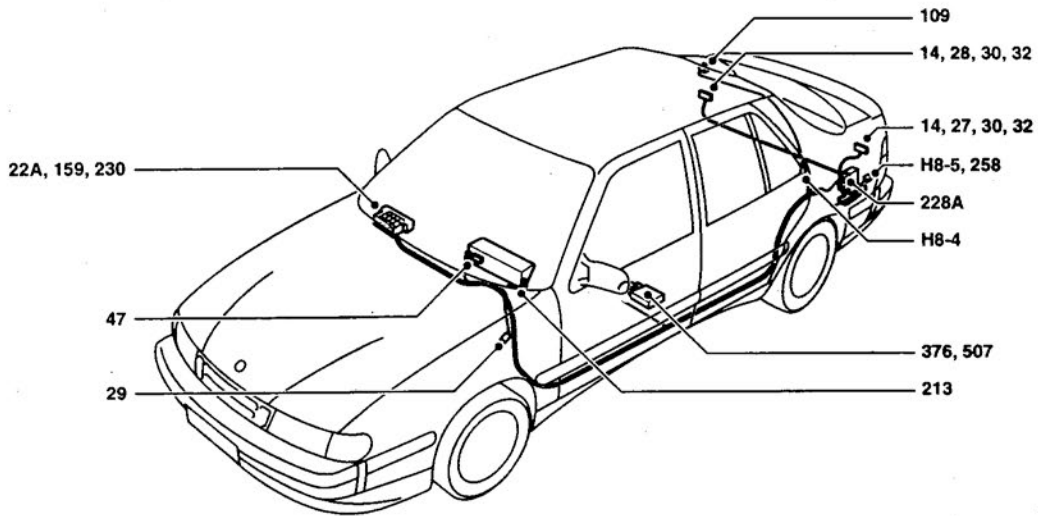

C351W-4520

Reversing lights CD

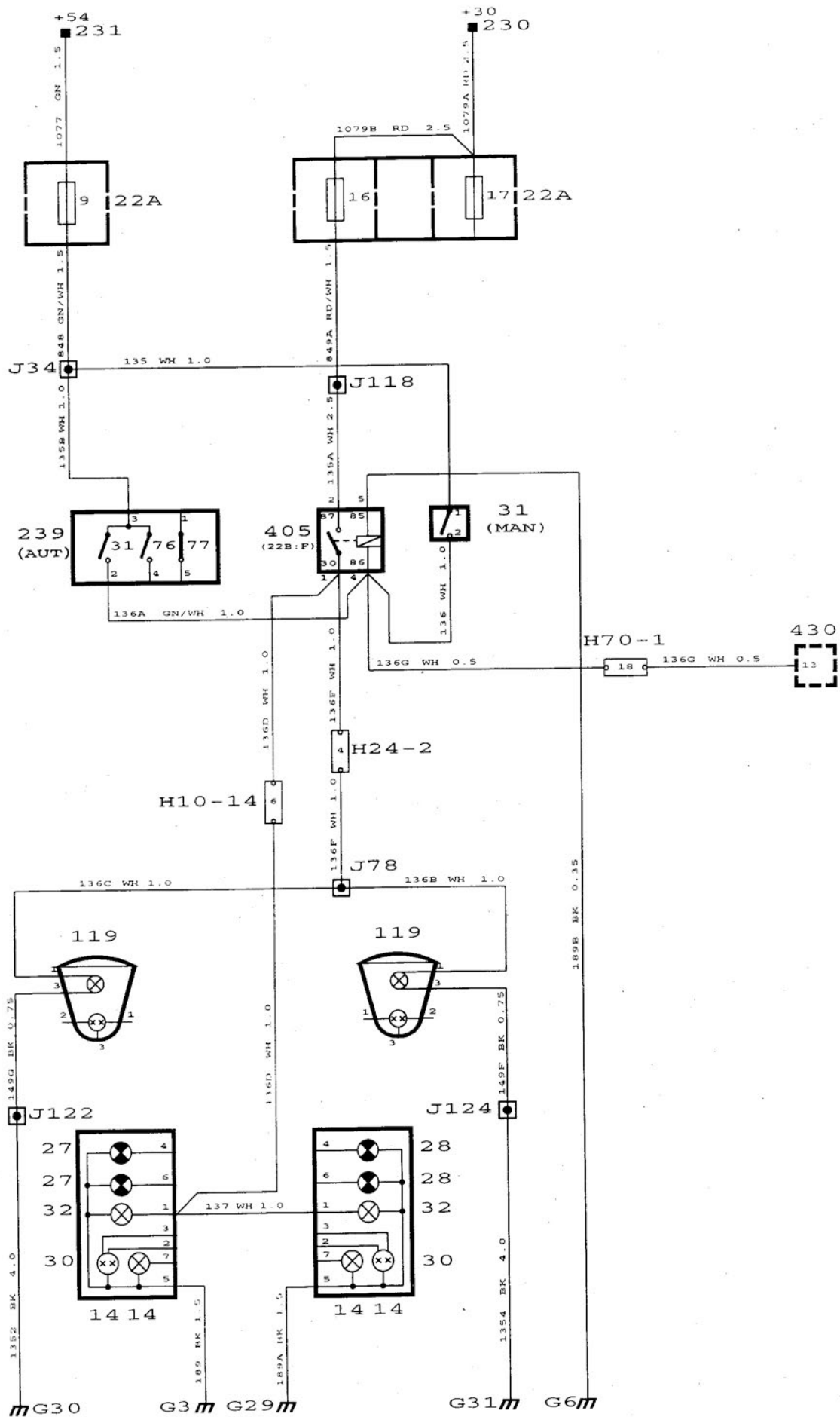

Reversing lights CS

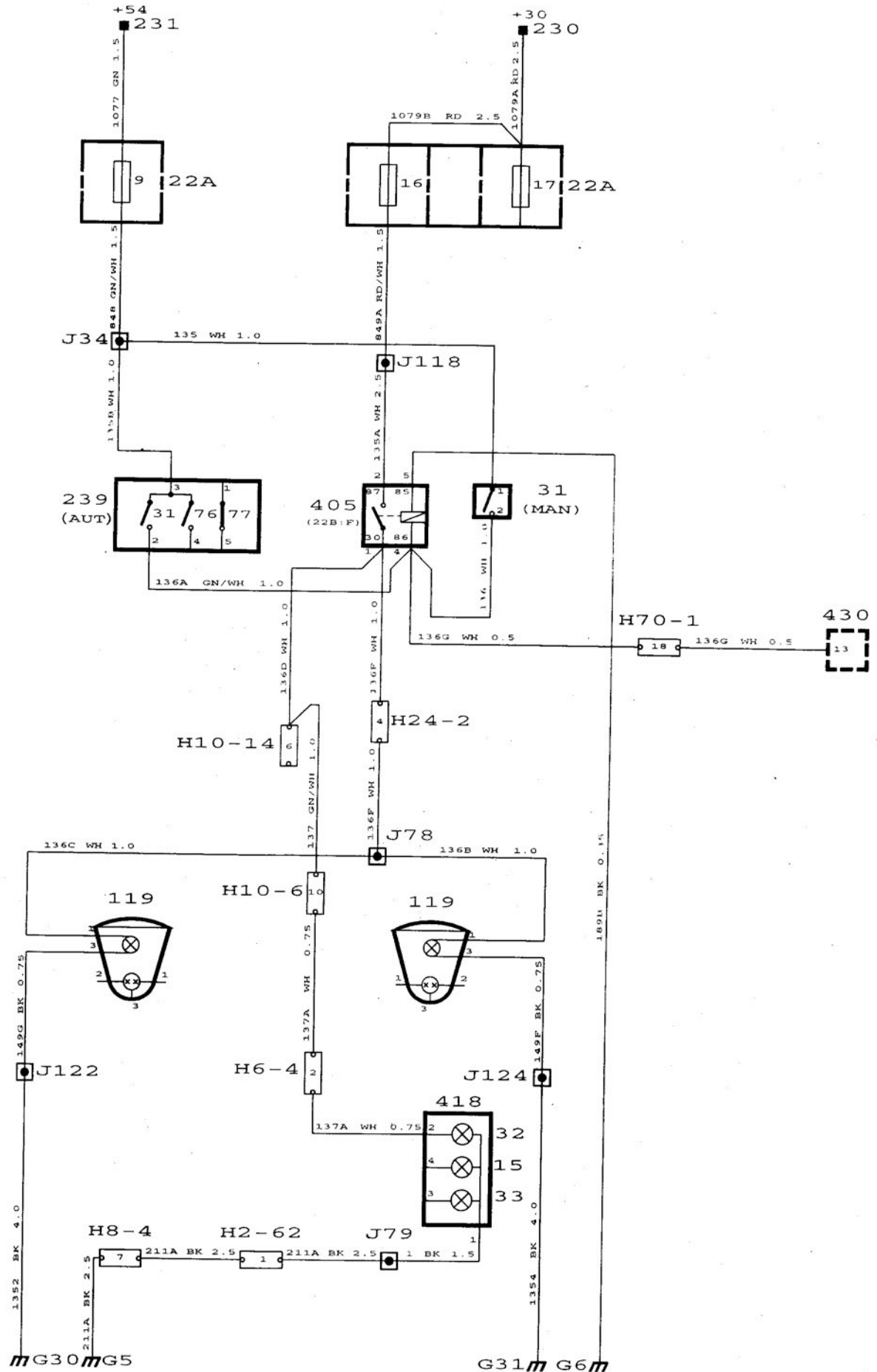

Description of operation

Voltage is fed from fuse 9 to reversing light switch 31. The switch closes when reverse gear is selected, lighting the lamps.

Automatic transmission

In cars with automatic transmission, reversing light switch 31 is located in transmission range switch 239. The switch closes when reverse gear is selected. Relay 405, the coil of which is grounded at grounding point G6, operates and the reversing lights light up.

Side reversing lights

Cars for certain markets incorporate side reversing lights 119 in the front light clusters.

Fault diagnosis hints

The reversing lights are switched on when reverse gear is engaged and the ignition switch is in the Drive position.

- 1 Check that fuses 9 and 16 are intact and supplied with current.
- 2 Check that the reversing light switch connections are supplied with current. On cars with automatic transmission, also check the relay connections.
- 3 Check that the bulbs are intact and supplied with current.
- 4 Check the connectors, wiring harness and ground connections.

Component locations

14	Rear lights in the rear light clusters.		<i>2-pin connector</i>
15	Number plate lighting in the tailgate.	H2-62	In the tailgate on the left-hand side.
22A	Fuse board behind the cover flap in the glove box.		<i>6-pin connector</i>
27	Direction indicator lamps, left-hand side, in front and rear light clusters.	H6-4	In the tailgate on the left-hand side.
28	Direction indicator lamps, right-hand side, in front and rear light clusters.	H8-4	By the left-hand rear wheel housing.
30	Brake lights in rear light clusters.	H10-6	By the left-hand rear wheel housing.
31	Reversing-light switch. Manual gearbox: on left-hand side of gearbox. Automatic transmission: in transmission range switch 239 by the selector lever.	H10-14	In the luggage compartment on the left-hand side beside the filament monitor and motorized aerial.
32	Rear light bulbs CD: in the rear light clusters. CD: in the tailgate.	H24-2	Behind the left-hand headlamp.
33	Rear fog light CD: in the rear light clusters. CS: in the tailgate light fitting.	H70-1	<i>70-pin connector</i> In the engine bay, behind the bulkhead partition.
119	Side reversing lights in the front light clusters.	G3	Grounding point, luggage compartment, left-hand side, under the left-hand rear light cluster.
230	Distribution terminal (+30 circuit) in main fuse box behind the glove box.	G5	Grounding point, rear seat, on left-hand side.
231	Distribution terminal (+54 circuit) in main fuse box behind the glove box.	G6	Grounding point, negative distribution terminal, in the main fuse box (22B) behind the glove box.
239	Transmission range switch beside the selector lever.	G29	Grounding point, luggage compartment, right-hand, under the right-hand rear light cluster
405	Relay, reversing light (automatic transmission), in main fuse box behind the glove box.	G30	Grounding point, left-hand structural member behind the left-hand headlamp.
418	Rear light fitting, CS, in the tailgate.	G31	Grounding point, right-hand structural member behind the right-hand headlamp.
430	Saab Trionic control module, in engine bay on the left behind the bulkhead partition.		

Components

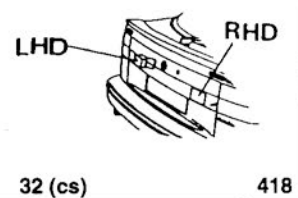
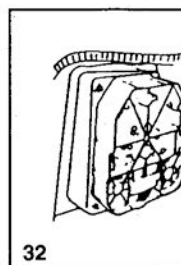
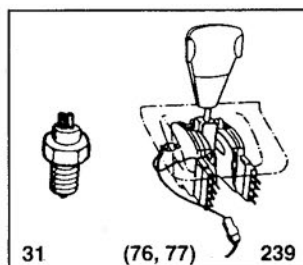
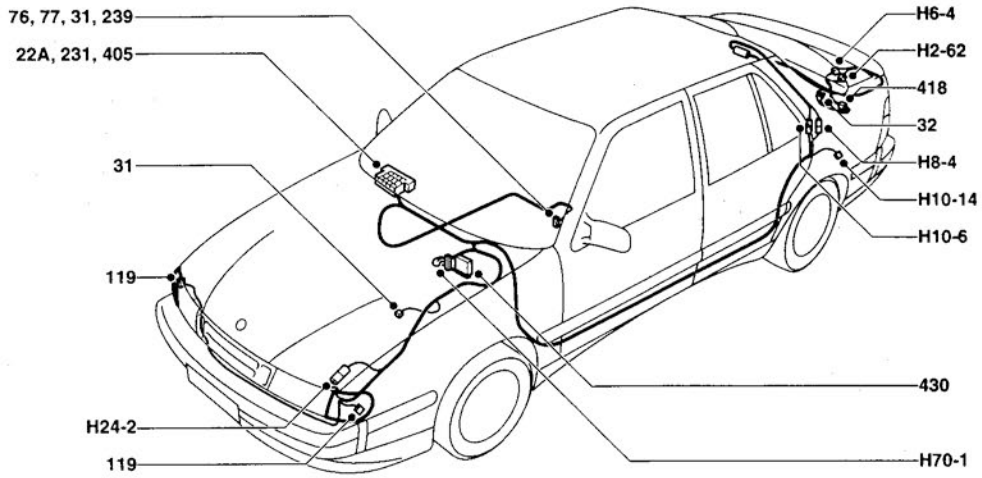

C351W-4521

Rear fog light CD

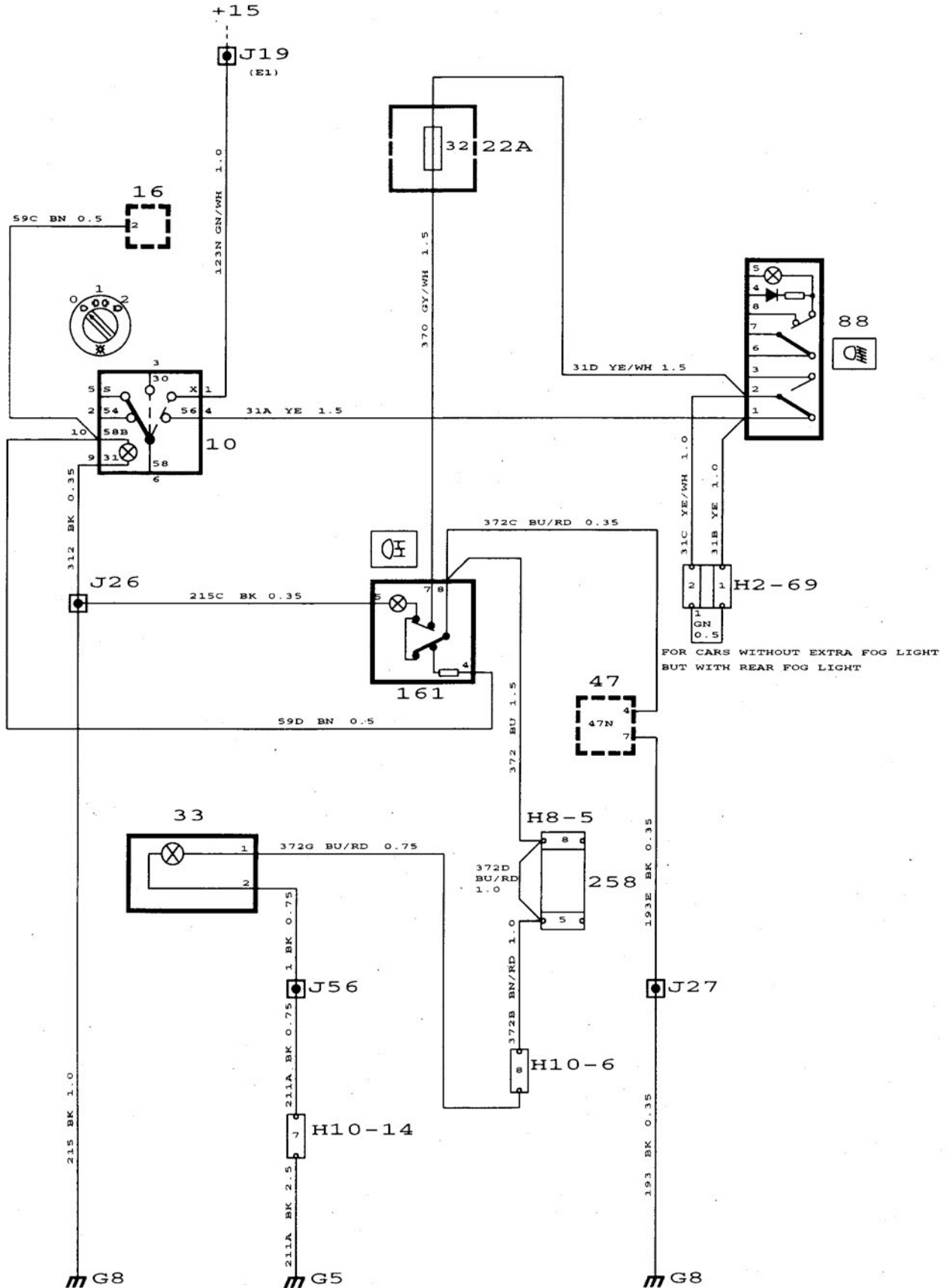

Rear fog light CS

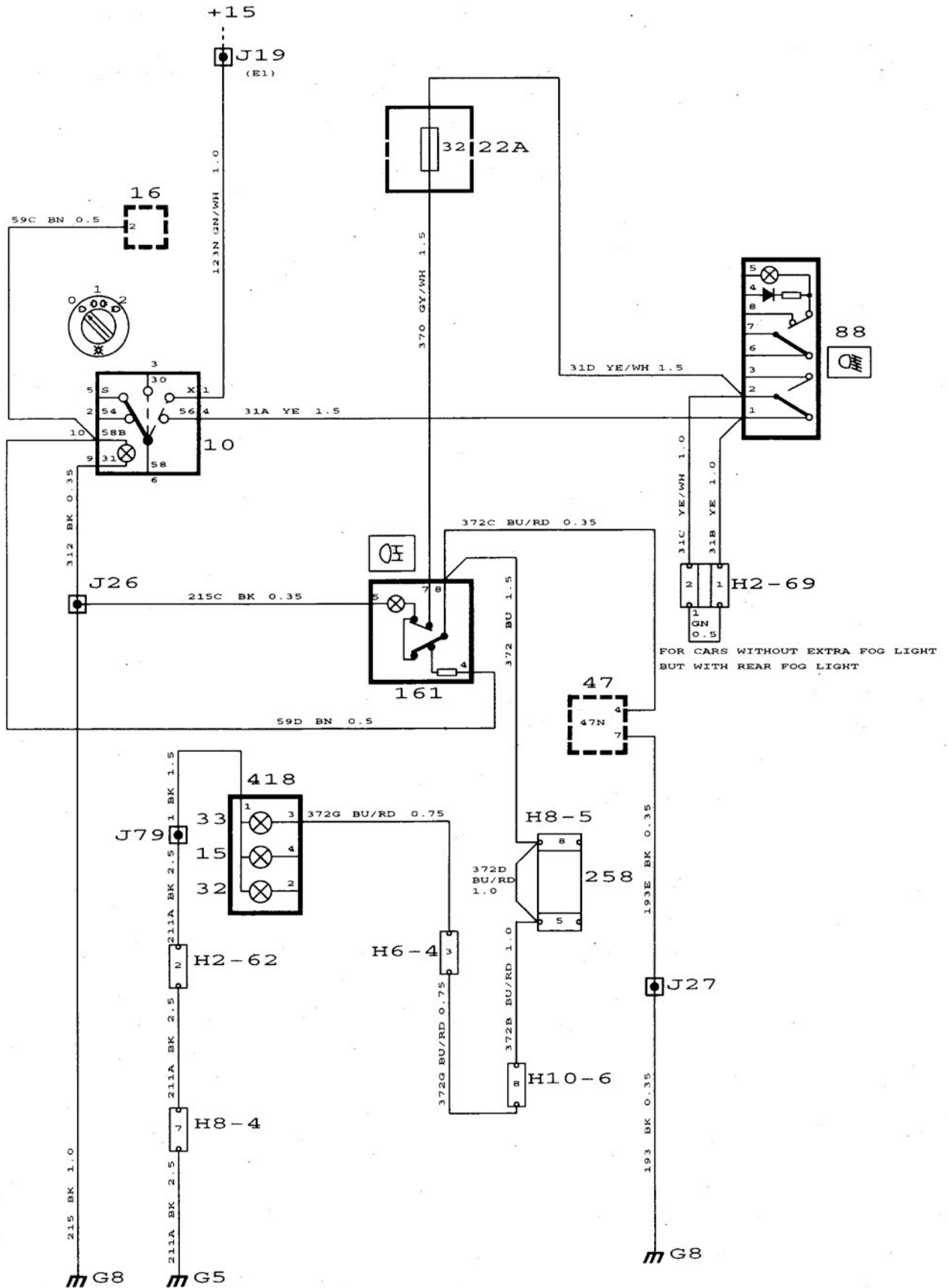

Description of operation

Cars for certain markets are fitted with a rear fog light. Before the rear fog light can be turned on, the ignition switch must be in the Drive position.

Current is supplied to light switch 10 via the ignition switch, which must be in position 2 for the rear fog light to light up (headlamps on).

Current is then supplied to the switch for rear fog light 161 via the switch for extra fog lights 88 and fuse 32. To enable the rear fog light to work on cars without extra fog lights, a jumper is connected via a 2-pin connector (H2-69).

When the rear fog light switch is depressed, rear fog light 33 lights up on the left-hand side on LHD cars and on the right-hand side on RHD cars. Indicator lamp 47N in the main instrument display panel also lights up.

At the same time as the switch is depressed, the lamp built into the button will be supplied with current directly and light up at full intensity.

The rear fog light on a trailer, if any, is supplied with current via connector 258 (H8-5).

Fault diagnosis hints

- 1 Check that fuse 32 is intact and supplied with current.
- 2 Check that the relevant bulb is OK and that it is supplied with current.
- 3 Check the connectors, wiring harness and ground connections.

Component locations

- 10 Lights switch on dashboard between steering wheel and driver's door.
- 15 Number plate lighting in the tailgate.
- 16 Rheostat, lighting for controls, on dashboard between the steering wheel and driver's door.
- 22A Fuse board behind the cover flap in the glove box.
- 32 Reversing lights
CD: in rear light clusters.
CS: in the tailgate.
- 33 Rear fog light
CD: in rear light cluster.
CS: in the tailgate.
- 47N Indicator lamp, rear fog lights, in main instrument display panel.
- 88A Switch, extra fog lights, on dashboard between the steering wheel and driver's door.
- 161 Switch, rear fog light, on dashboard between the steering wheel and driver's door.
- 258 (H8-5) Connection for trailer lighting, in luggage compartment below the left-hand light cluster.
- 418 Rear light fitting, CS, in the tailgate.
- 2-pin connectors*
- H2-62 In the tailgate on the left-hand side.
- H2-69 Behind the extra fog light switch.
- 6-pin connector*
- H6-4 In the tailgate on the left-hand side beside the rear window.
- 8-pin connector*
- H8-4 By the left-hand rear wheel housing.
- 10-pin connectors*
- H10-6 By the left-hand rear wheel housing.
- H10-14 In the luggage compartment on the left-hand side, beside the filament monitor.
- G5 Grounding point, rear seat, on left-hand side.
- G8 Grounding point, dashboard, by the left-hand front loudspeaker socket.

Components

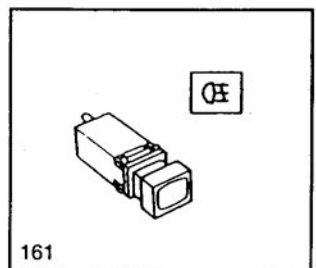
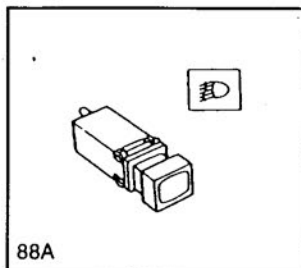
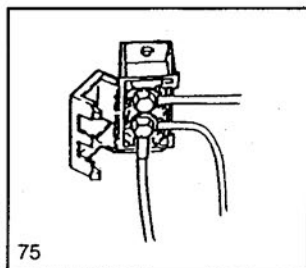
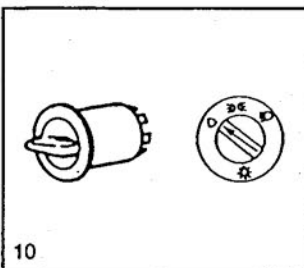
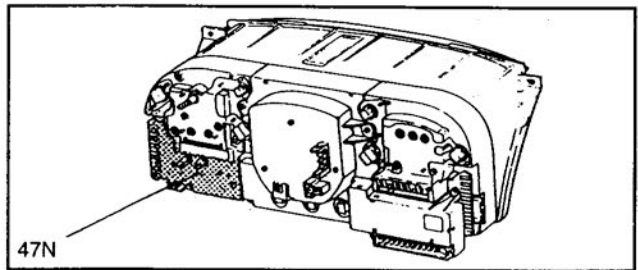
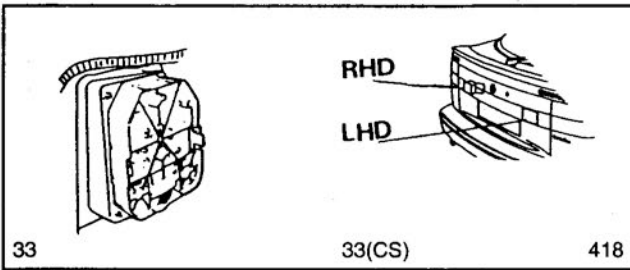
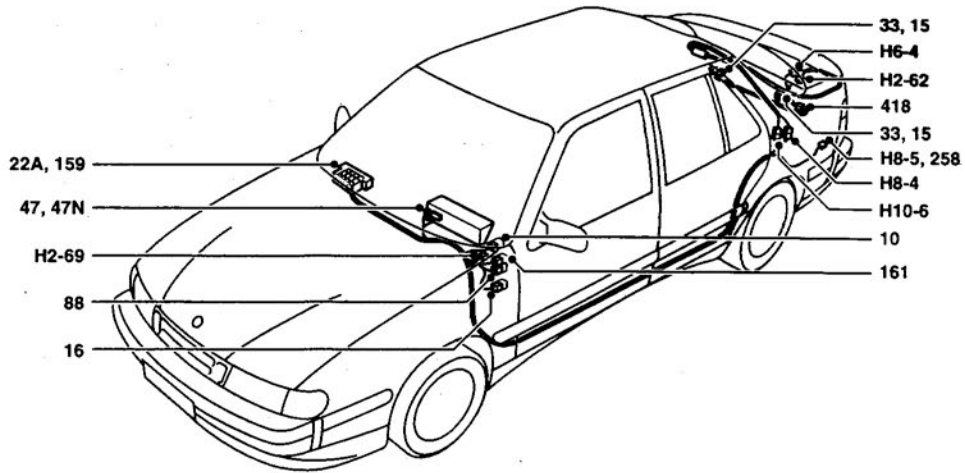

Direction indicators, hazard flashers

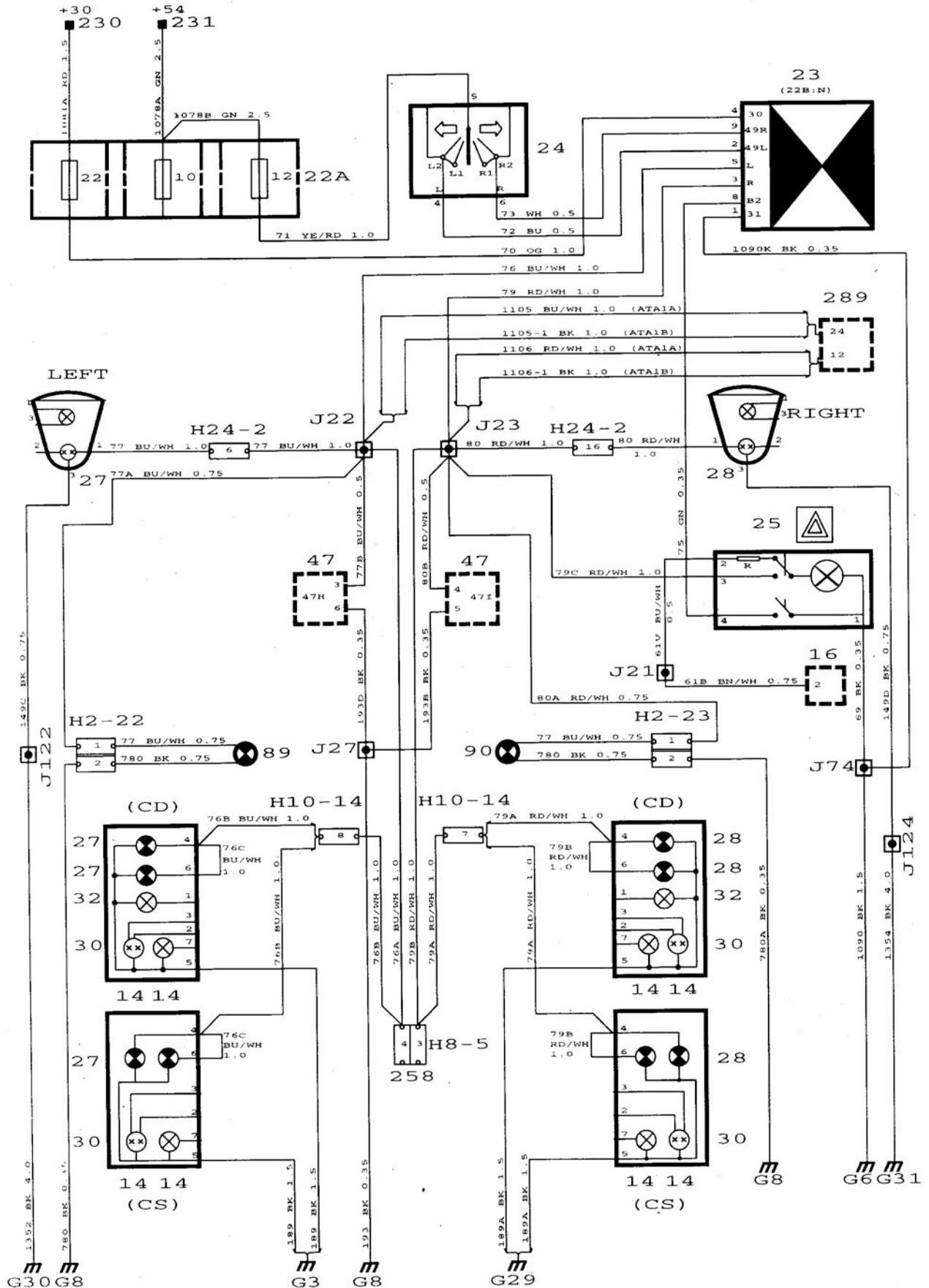

ATA1A = US/CA
 ATA1B = SE/EU/GB/ME/PA/LA/AU

Description of operation

Direction indicators

Voltage is fed from fuse 12 to the direction indicator stalk switch and then on to flasher relay 23. From the flasher relay, current pulses then go to the left-hand or right-hand direction indicator lamps via fuse 22.

In stalk switch positions L1 and R1, the left-hand and right-hand direction indicator lamps respectively are connected as long as the stalk switch is held in the appropriate position. In positions L2 and R2, connection takes place in the same way except that disconnection is automatic when the steering wheel returns to the straight ahead position.

The two indicator lamps 47H (left-hand side) and 47I (right-hand side) are connected in parallel with the relevant direction indicator lamps on the outside of the car.

Direction indicator lamps on a trailer, if any, are supplied with current via connector 258 (H8-5).

In addition, the car is equipped with side direction indicator lamps 89 (left) and 90 (right).

The direction indicator bulbs are duplicated in the rear lights. If one bulb fails, the other bulb still carries on working and the flasher relay will start to work faster.

Hazard flashers

Voltage is fed from fuse 22 to flasher relay 23, connection 30.

Switch 25 for the hazard flashers closes the contact in the switch and connection B2 in flasher relay 23 is grounded.

From the flasher relay, current pulses go to the left-hand and right-hand direction indicators, to the two indicator lamps 47H and 47I and to side direction indicators 89 and 90, which then start to flash.

When the switch is activated, the indicator lamp in the switch also lights up.

Direction indicators/hazard flashers on any trailer are supplied with current via connector 258 (H8-5).

Fault diagnosis hints

Direction indicators

The car's direction indicators are operative only when the ignition switch is in the Drive position.

- 1 Check that fuses 12 and 22 are intact and supplied with current.
- 2 Check that current is supplied to connection 5 on direction indicator stalk switch 24.
- 3 Check that current is supplied to flasher relay connections 49L and 49R when the direction indicator stalk switch is moved to left and right.
- 4 Also check that the bulbs are intact and supplied with current.
- 5 Check the connectors, wiring harness and ground connections.

Hazard flashers

The car hazard flashers are always supplied with current via flasher relay 23.

- 1 Check that fuse 22 is intact and supplied with current.
- 2 Check that current is supplied to connection 30 on flasher relay 23.
- 3 Activate the switch and check that connection B2 on flasher relay 23 is grounded to the switch.
- 4 Check that the bulbs are OK and supplied with current.
- 5 Check the connectors, wiring harness and ground connections.

Component locations

16	Rheostat, lighting for controls, on dashboard between the steering wheel and driver's door.	H2-22	2-pin connectors Beside the left-hand side direction indicator light (green contact).
14	Rear lights in the rear light clusters.	H2-23	Beside the right-hand side direction indicator light (green contact).
22A	Fuse board behind the cover flap in the glove box.		10-pin connector
23	Flasher relay in main fuse box behind the glove box.	H10-14	In the luggage compartment on the left-hand side beside the filament monitor.
24	Stalk switch, direction indicators, on the left of the steering column.		24-pin connector
25	Switch, hazard flashers, on dashboard by the centre air vent.	H24-2	Behind the left-hand headlamp.
27	Direction indicator lamps, left-hand side, in front and rear light clusters.	G3	Grounding point, luggage compartment, left-hand side, under the left-hand rear light cluster.
28	Direction indicator lamps, right-hand side, in front and rear light clusters.	G6	Grounding point, negative distribution terminal, in main fuse box behind the glove box.
30	Brake lights in rear light clusters.	G8	Grounding point, dashboard, by the left-hand front loudspeaker socket.
32	Rear lights CD: in rear light clusters. CS: in tailgate light fitting.	G29	Grounding point, luggage compartment, on the right-hand side by the right-hand rear light cluster.
	<i>in the main instrument display panel</i>	G30	Grounding point, left-hand structural member behind the left-hand headlamp.
47H	Indicator lamp, left-hand direction indicators.	G31	Grounding point, right-hand structural member behind the right-hand headlamp.
47I	Indicator lamp, right-hand direction indicators.		
89	Side direction indicators, left, on the left-hand front wing.		
90	Side direction indicators, right, on the right-hand front wing.		
230	Distribution terminal (+30 circuit) in main fuse box behind the glove box.		
231	Distribution terminal (+54 circuit) in main fuse box behind the glove box.		
258 (H8-5)	Connection for trailer lighting, in luggage compartment below the left-hand light cluster.		
289	Anti-theft alarm control module, on right-hand side under the dashboard behind the knee shield.		

Components

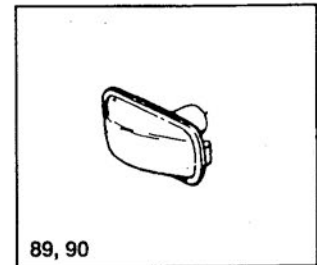
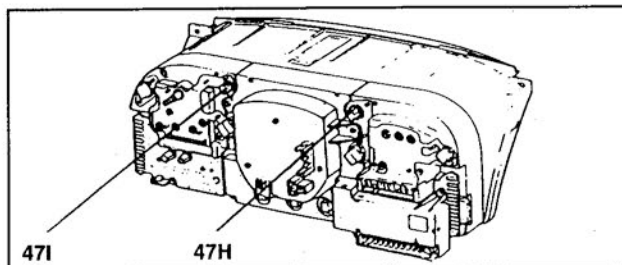
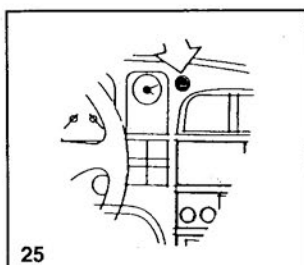
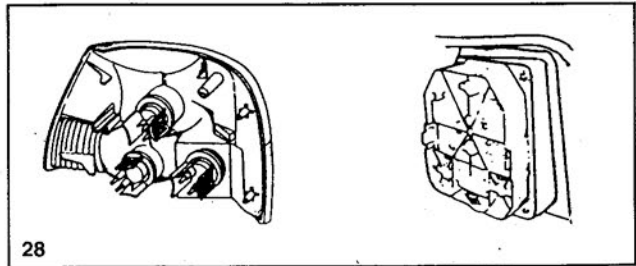
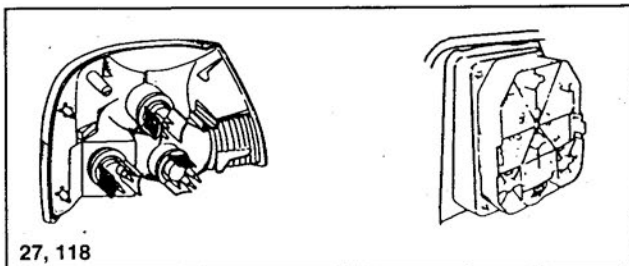
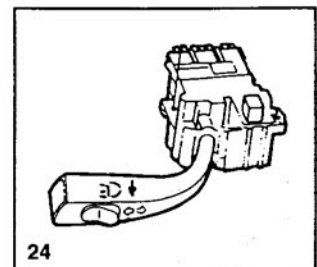
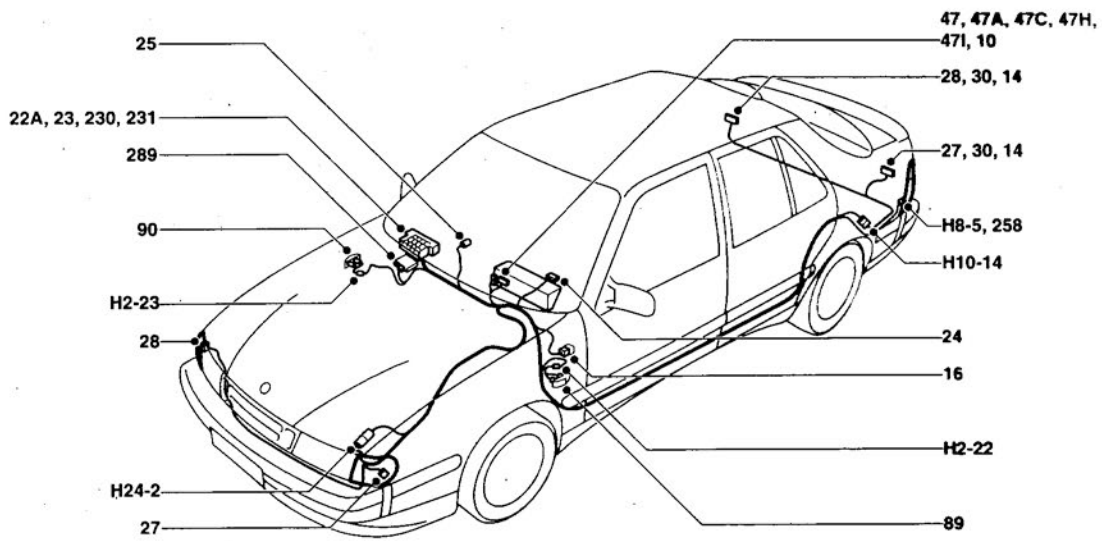

Courtesy lights

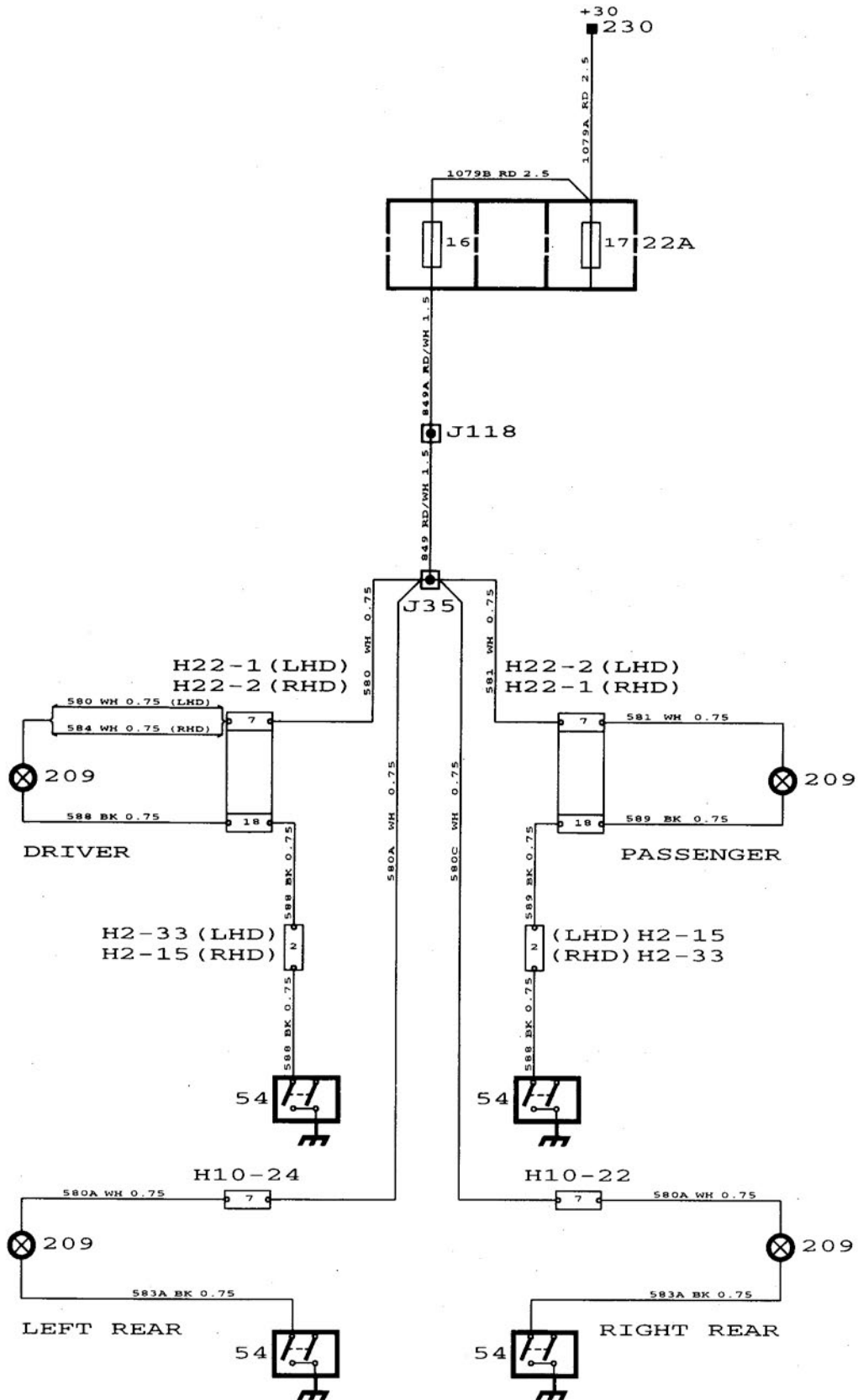

Description of operation

Courtesy lights

Voltage is fed from fuse 16 to courtesy lights 209 and door switch 54 in each door pillar.

When a door is opened, the door switch closes and the lighting in the door goes on. The door switch is of 2-pole type and in addition to the courtesy lights also controls the interior lighting.

Fault diagnosis hints

- 1 Check that fuse 16 is intact and supplied with current.
- 2 Check that the bulb in question is intact and supplied with current.
- 3 Check that the door switch in question is in proper working order.
- 4 Check the connectors, wiring harness and ground connections.

Component locations

- 22A Fuse board behind the cover flap
in the glove box.
- 54 Door switch in each door pillar.
- 209 Courtesy light in each door.
- 230 Distribution terminal (+30 circuit) in
main fuse box behind the glove
box.
- 2-pin connectors*
- H2-15 In the right-hand A pillar.
- H2-33 In the left-hand A pillar.
- 10-pin connectors*
- H10-22 In right-hand B pillar.
- H10-24 In left-hand B pillar.
- 22-pin connectors*
- H22-1 Behind the cable entry in the left-
hand A pillar.
- H22-2 Behind the cable entry in the right-
hand A pillar.

Components

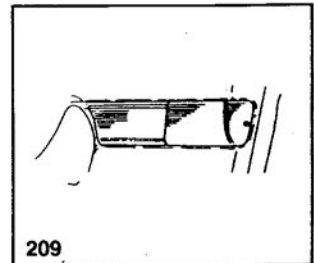
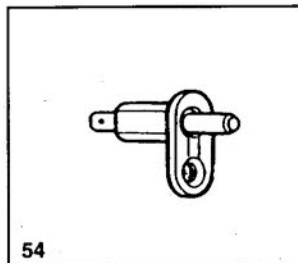
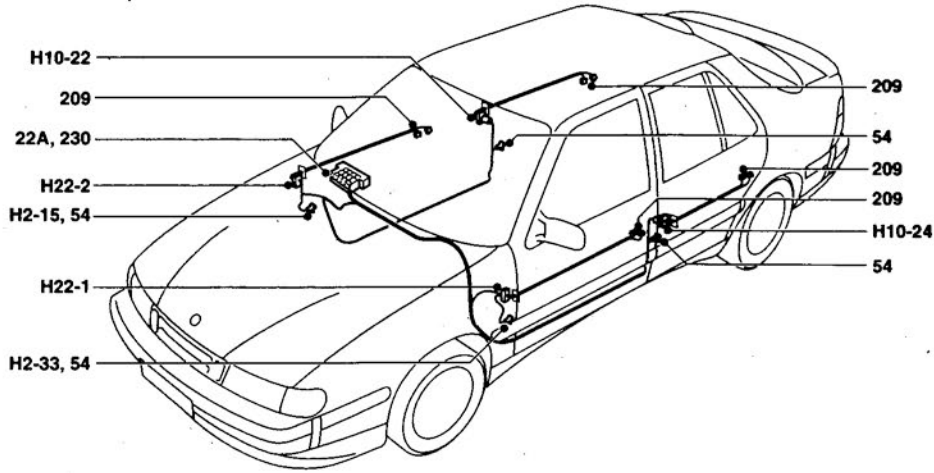

C351W-4524

Interior lighting

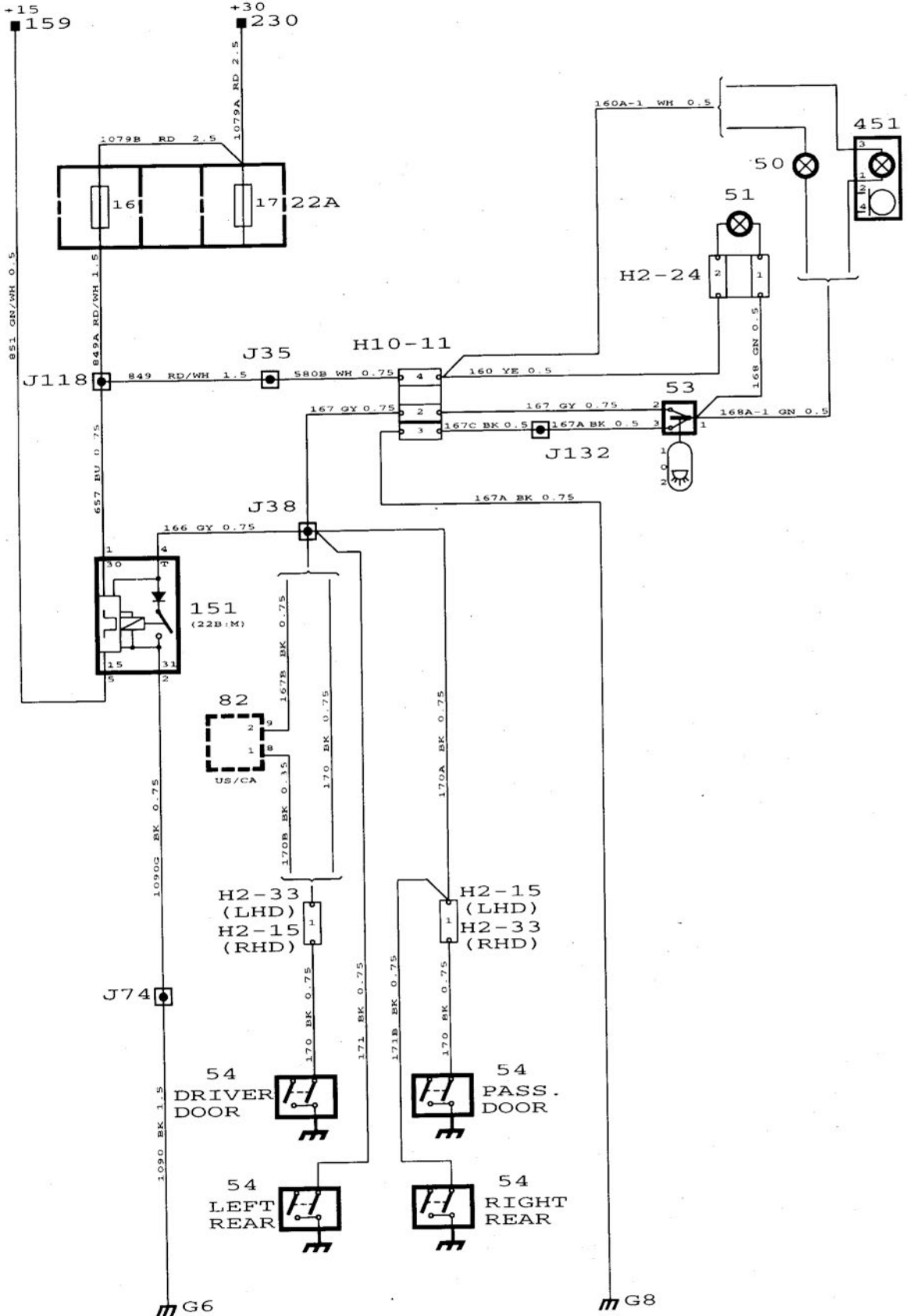

Description of operation

Interior lighting with/without time delay

For certain markets/models, the interior lighting circuit incorporates relay 151 which gives a time delay.

The lighting circuit and the time-delay relay are supplied with current via fuse 16. The relay is also supplied with current from the +15 circuit.

The interior lighting comes on when a door is opened. Door switch 54 then closes and relay 151 operates since its connection (T) is grounded. When the door is closed, the circuit is broken. The interior lighting remains on, however, because the relay's time-delay circuit maintains the ground connection across contacts T and 31.

The time delay is about 15 seconds, but will be interrupted if the ignition switch is turned to the Drive position. Relay connections 15 and 30 will then both be supplied with positive voltage, at which point the relay releases and the ground circuit across contacts T and 31 is broken.

Fault diagnosis hints

- 1 Check that fuse 16 is intact and supplied with current.
- 2 Check that lamps 50 and 51 are OK and supplied with current.
- 3 Check that connection 30 of relay 151 is supplied with current.
- 4 Turn the ignition switch to the Drive position. Check that fuse 13 is intact and supplied with current.
- 5 Check that relay connection 15 is supplied with current.
- 6 Check that switch 53 is in working order.
- 7 Check the door switches, connectors, wiring harness and ground connections.

Component locations

22A	Fuse board behind the cover flap in the glove box.
50	Roof lamp, rear.
51	Roof lamp, front.
53	Switch, interior lighting, in centre console by the gear lever.
54	Door switch in each door pillar.
82	Relay, seat-belt/key reminder, in main fuse box behind the glove box.
151	Time-delay relay, delayed interior lighting, in main fuse box behind the glove box.
159	Distribution terminal (+15 circuit), in main fuse box behind the glove box.
230	Distribution terminal (+30 circuit), in main fuse box behind the glove box.
451	Glass breakage sensor, in front roof lamp. <i>2-pin connectors</i>
H2-15	In the right-hand A pillar.
H2-24	Under the roof console beside the interior rear-view mirror.
H2-33	In the left-hand A pillar. <i>10-pin connector</i>
H10-11	On the far left under the dashboard, behind the knee shield.
G6	Grounding point, negative distribution terminal, in main fuse box 22B behind the glove box.
G8	Grounding point, dashboard, by the left-hand front loudspeaker socket.

Components

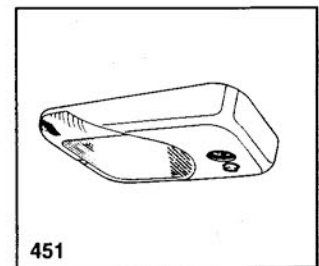
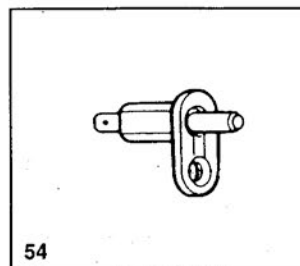
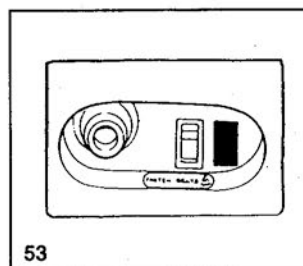
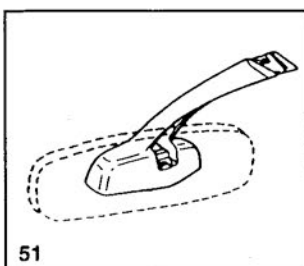
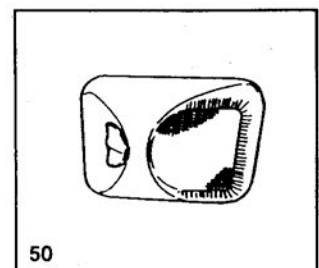
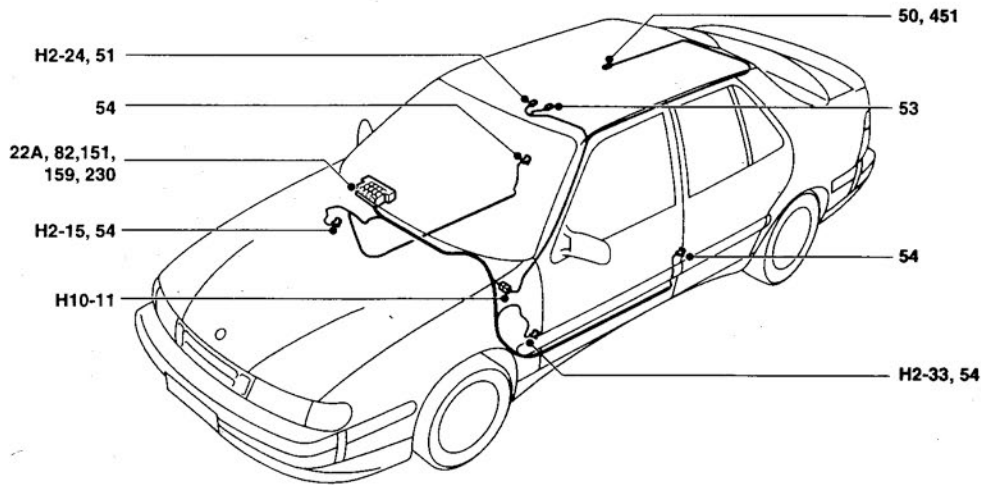

C351W-4525

Luggage compartment lighting

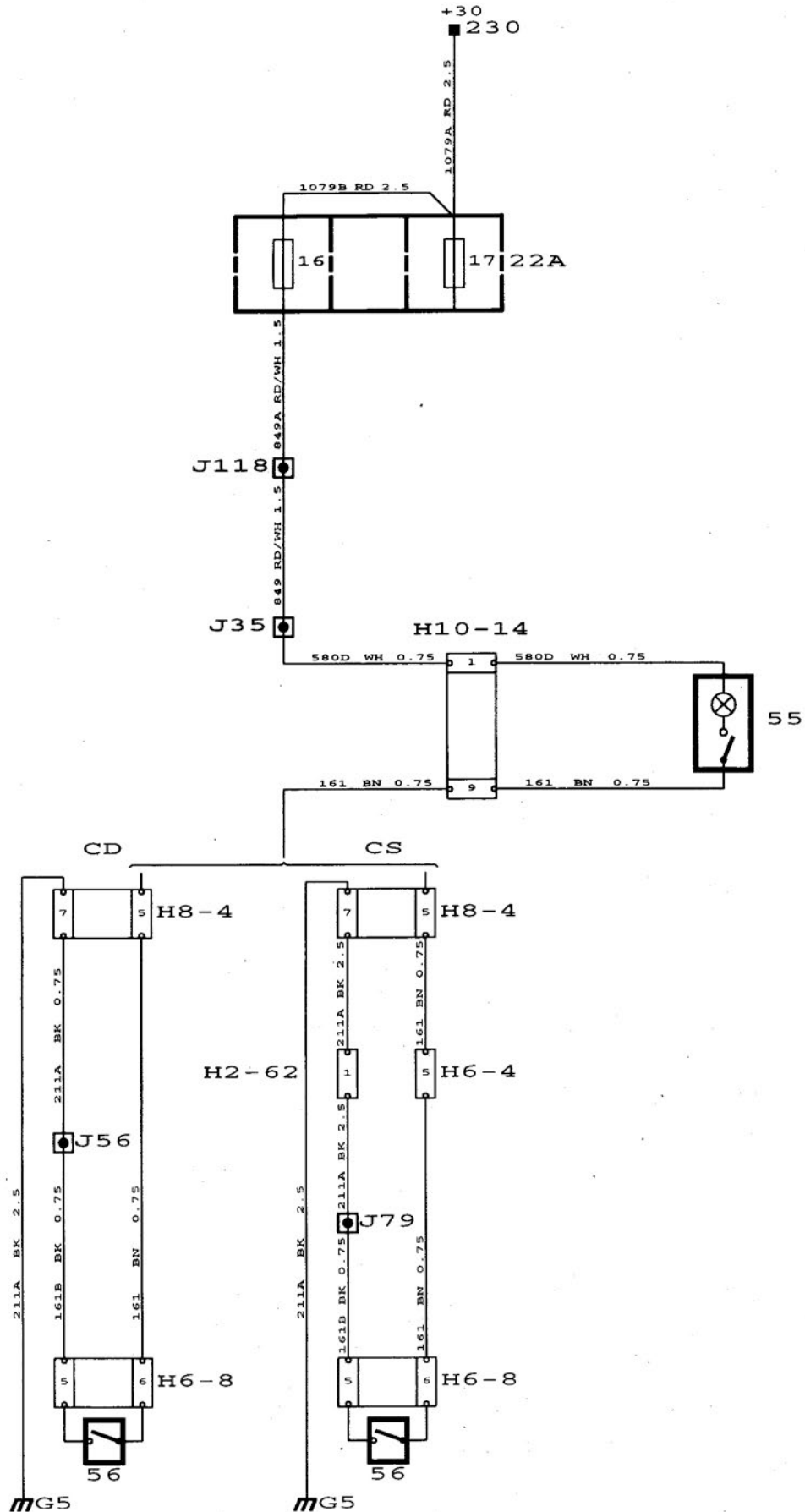

Description of operation

Current is supplied via fuse 16 to luggage compartment lamp 55 and on to switch 56. When the tailgate is opened, the switch closes the circuit to ground and the lamp lights up.

The luggage compartment lighting can be switched off manually by means of the switch on the lamp.

Fault diagnosis hints

- 1 Check that fuse 16 is intact and supplied with current.
- 2 Check that the bulb is OK and supplied with current.
- 3 Check that the switch on the lamp and the luggage compartment switch are in working order.
- 4 Check the connectors, wiring harness and ground connections.

Component locations

- 22A Fuse board behind the cover flap in the glove box.
- 55 Luggage compartment lamp, on the right-hand side in the luggage compartment.
- 56 Luggage compartment lighting switch, in the tailgate.
- 230 Distribution terminal (+30 circuit) in main fuse box behind the glove box.
2-pin connector
- H2-62 In the tailgate on the left-hand side.
6-pin connector
- H6-4 In the tailgate on the left-hand side beside the rear window.
8-pin connector
- H8-4 By the left-hand rear wheel housing.
10-pin connector
- H10-14 In the luggage compartment on the left-hand side, beside the filament monitor.
- G5 Grounding point, rear seat, left-hand side.

Components

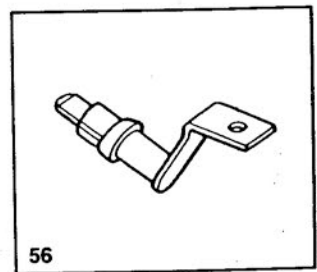
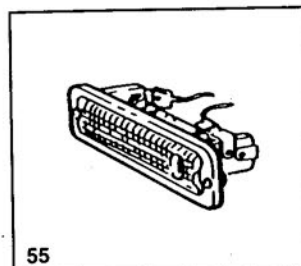
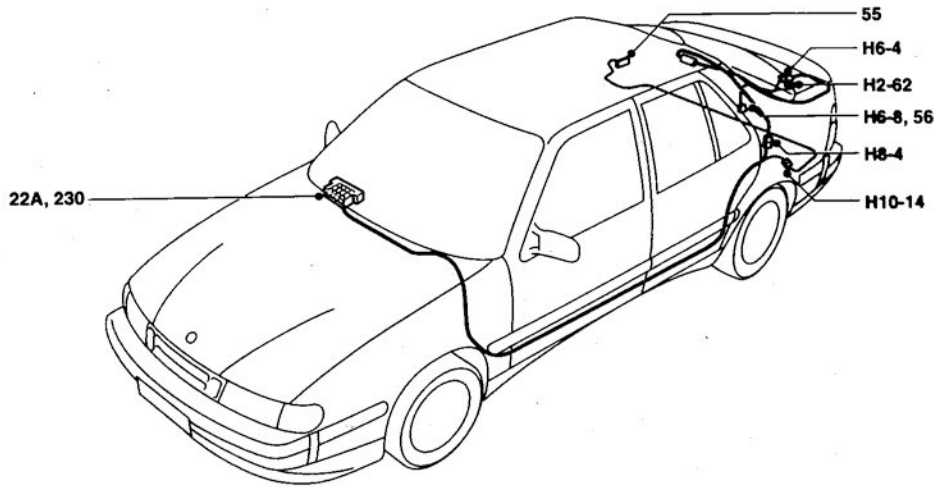

C351W-4526

Glove box light

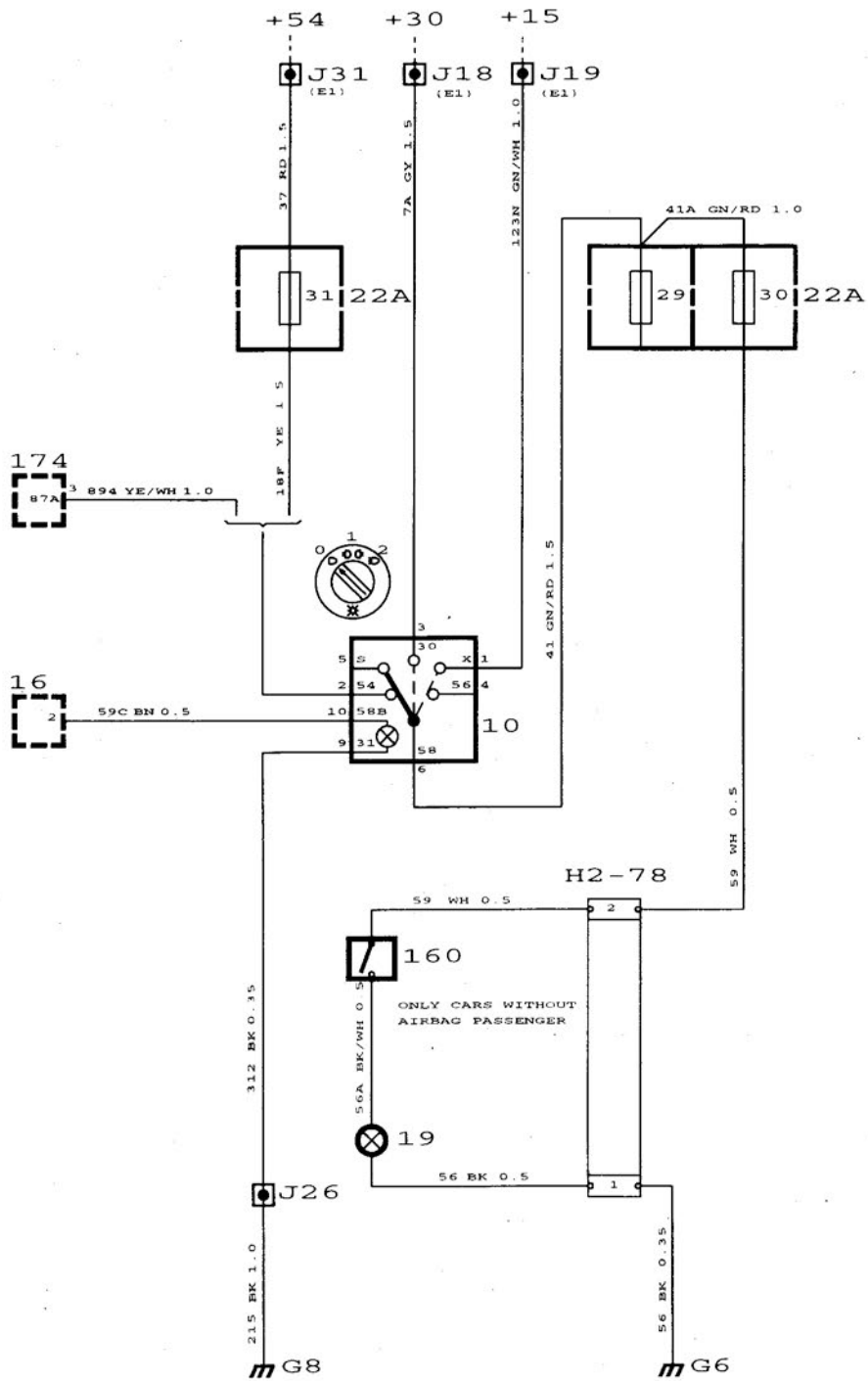

Description of operation

Glove box light

When light switch 10 is in position 1 (parking position) or position 2 (headlamps), current is supplied via fuse 30 to switch 160 in the glove box. When the glove box door is opened, the switch grounds the circuit and lamp 19 lights up.

Cars for certain markets are fitted with daylight driving lights. Either the daylight driving lights relay or fuse 31 supplies positive voltage to switch 160, even when the light switch is in position 0.

Fault diagnosis hints

- 1 Check that fuses 30 and 31 are intact and supplied with current.
- 2 Check lamp 19.
- 3 Check switch 160.
- 4 Check the connectors, wiring harness and ground connections.

Component locations

- 10 Lights switch on dashboard between steering wheel and driver's door.
- 16 Rheostat, lighting for controls, on dashboard between the steering wheel and driver's door.
- 19 Lighting, in glove box.
- 22A Fuse board behind the cover flap in the glove box.
- 160 Switch, for glove box lighting, in glove box on right-hand side.
- 174 Relay, daylight driving lights, in main fuse box behind the glove box.
2-pin connector
- H2-78 Behind the glove box beside the glove box lamp.
- G6 Grounding point, negative distribution terminal, in main fuse box behind the glove box.
- G8 Grounding point, dashboard, beside the front left-hand speaker socket.

Components

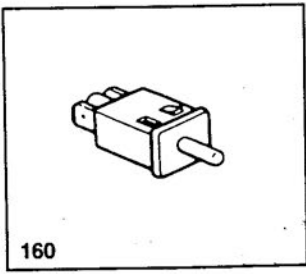
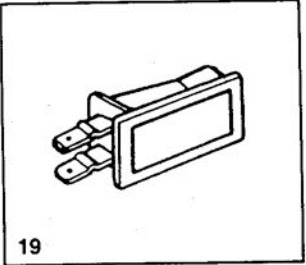
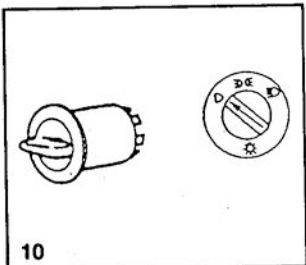
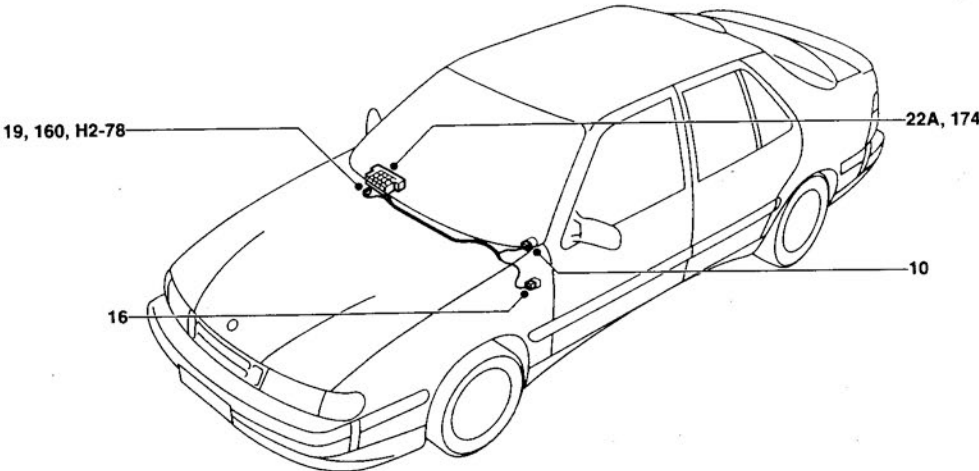

C351W-452B

Reading lamps and illuminated vanity mirrors

(SOP) This wiring diagram has been superseded during the model year by the schematic on the next page.

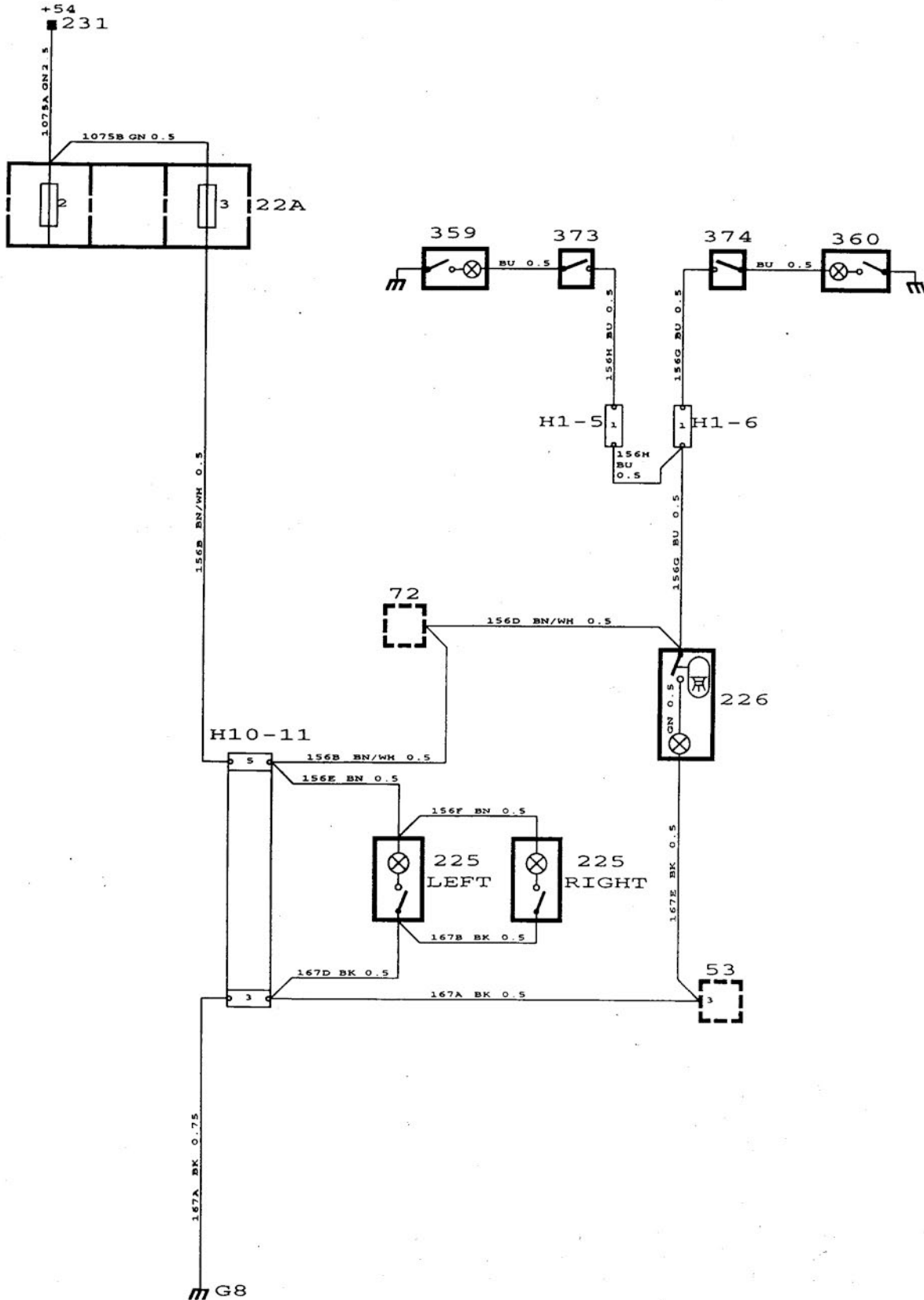

Reading lamps and illuminated vanity mirrors

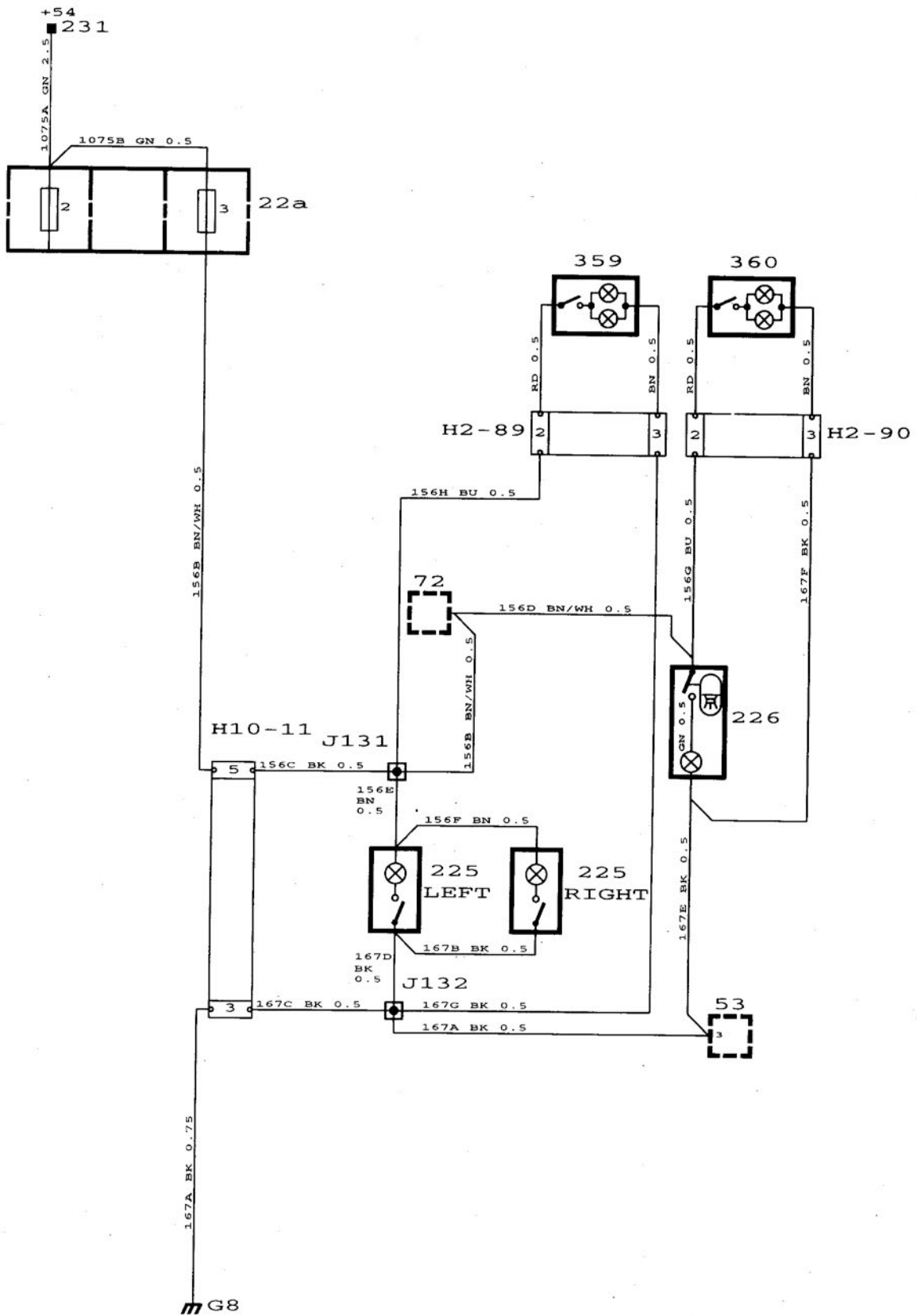

Description of operation

Reading lamps

Reading lamps for the rear seat passengers are provided in both C pillars. For the front seat passenger, a reading lamp is located in the roof console beside the interior rear-view mirror.

The lamps are of spotlight type and can be switched on and off by means of the switch beside each lamp.

Current is supplied via fuse 3 to lamp 226 and on to lamps 225.

Lighting for vanity mirrors

Cars for certain markets are equipped with lighting for the vanity mirrors in the car's sun visors. Lamps 359 and 360 are supplied with current via switches 373 and 374.

The switches are located beside the inner mounting of each sun visor. The lights go on when the sun visors are folded down but can be turned off using the integral switches. The switches are controlled by the sliding cover in front of each mirror.

The fitting of switches 373 and 374 has been discontinued during the model year.

Fault diagnosis hints

Reading lamps

- 1 Check that fuse 3 is intact and supplied with current.
- 2 Check the switches on each lamp.
- 3 Check the connectors, wiring harness and ground connections.

Lighting for vanity mirrors

- 1 Check that fuse 3 is intact and supplied with current.
- 2 Check switches 373 and 374.
- 3 Check the switches on each lamp.
- 4 Check the connectors, wiring harness and ground connections.

Component locations

- 22A Fuse board behind the cover flap in the glove box.
- 53 Switch, interior lighting, in centre console by the gear lever.
- 72 Seat-belt warning lamp, in roof console above the interior rear-view mirror.
- 225 Reading lamp, in each C pillar.
- 226 Passenger reading lamp, in the roof console beside the interior rear-view mirror.
- 231 Distribution terminal (+54 circuit) in main fuse box behind the glove box.
- 359 Lighting, vanity mirror, in left-hand sun visor.
- 360 Lighting, vanity mirror, in right-hand sun visor.
- 373 Main switch, left-hand vanity mirror, beside the sun visor's inner mounting.
- 374 Main switch, right-hand vanity mirror, beside the sun visor's inner mounting.
- 1-pin connectors*
- H1-5 In the roof console, beside the interior rear-view mirror.
- H1-6 In the roof console, beside the interior rear-view mirror.
- 10-pin connector*
- H10-11 On the far left under the dashboard behind the knee shield.
- G8 Grounding point, dashboard, beside the front left-hand speaker socket.

Components

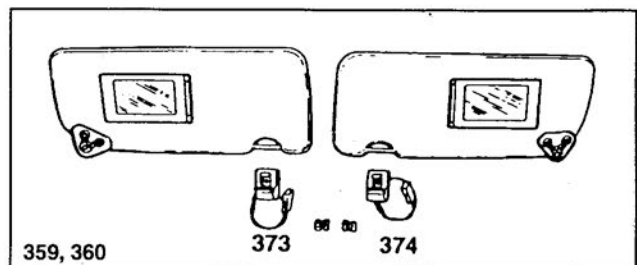
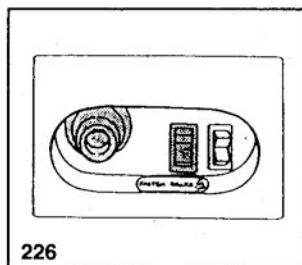
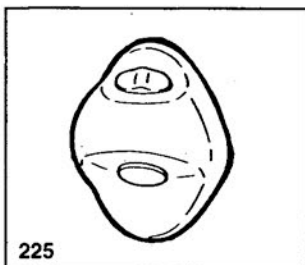
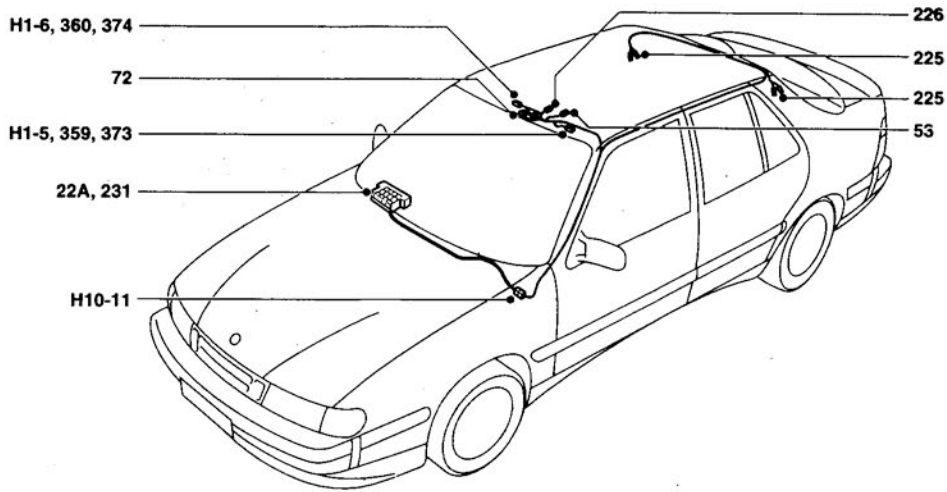

C351W-4527

Lighting for instruments and controls

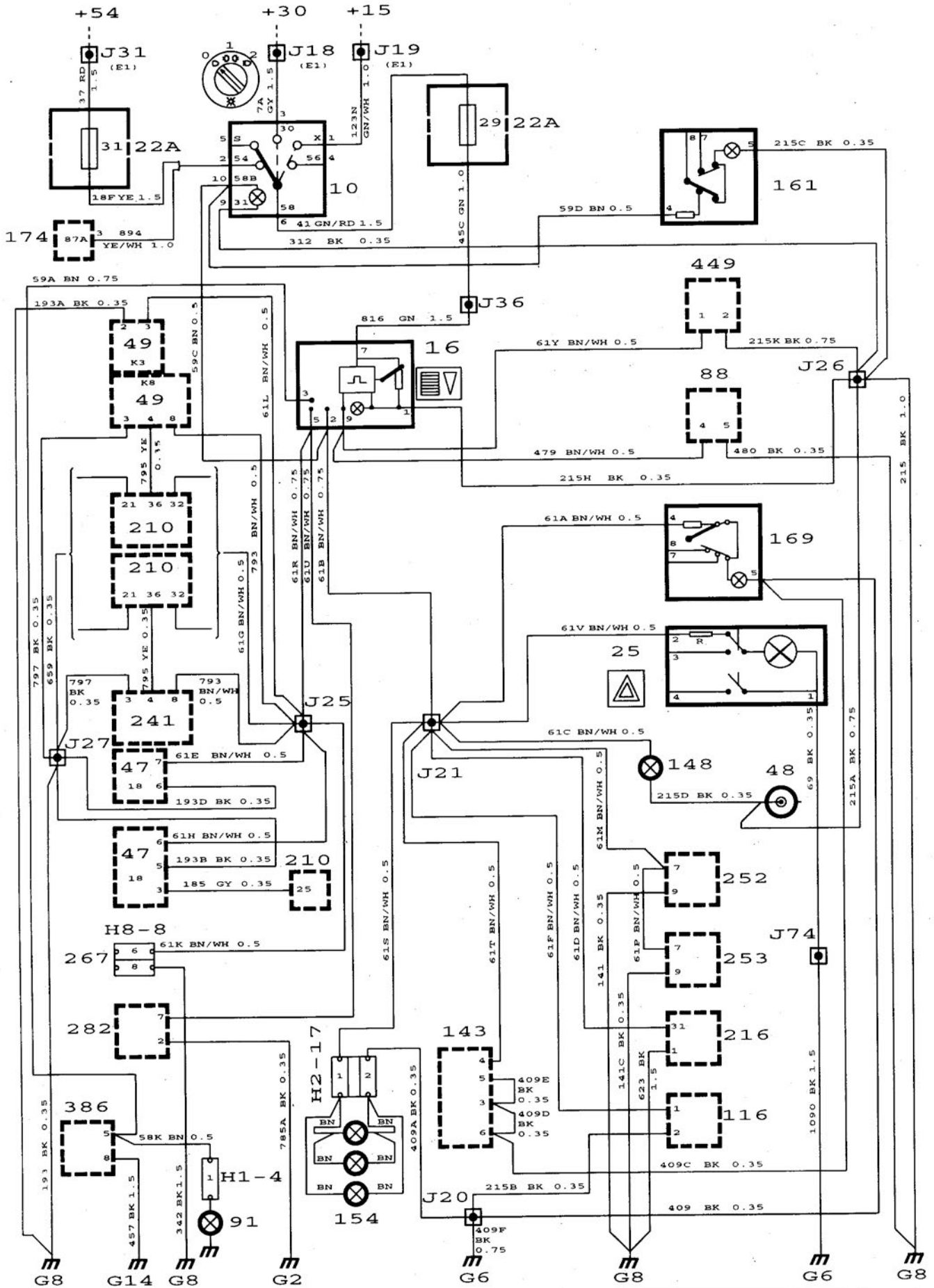

Description of operation

Rheostat 16, lighting for controls, is equipped with an internal electronic unit.

The rheostat is supplied with current via fuse 29. It is used for steplessly adjusting the brightness of the lighting of connected components by means of a PWM signal.

The brightness of the lighting of the rheostat is also adjusted at the same time.

Current from pin 2 is supplied to the following components:

10	Lights switch
25	Hazard flashers switch
116	Electrically heated rear window switch
143	Switch, recirculation
148	Ashtray lighting, front
154	Lighting, heater controls
161	Rear fog light switch
169	Switch, A/C
216	Climate control unit
252	Rheostat, heating pad, driver's seat
253	Rheostat, heating pad, passenger's seat
267	Radio dial illumination

Current from pin 3 of the rheostat is supplied to the following components:

91	Selector lever indicator
386	Switches, electric window lifts, electrically operated sunroof

Current from pin 5 is supplied to the following components:

18	Lighting, main instrument display panel 47
49/241	Clock or SCC trip computer
210	EDU trip computer
267	Radio dial illumination
282	Headlamp beam adjustment switch

Current from pin 9 of the rheostat is supplied to the following components:

88	Extra fog lights switch
449	TCS ON/OFF switch

Fault diagnosis hints

- 1 Check that fuse 29 is intact and supplied with current.
- 2 Check that current is supplied to pin 7 of the rheostat.
- 3 Check that pins 2, 3, 5 and 9 of the rheostat are live.
- 4 Check that pin 1 of the rheostat is connected to ground.
- 5 Check that the connections and grounding of each component are satisfactory.

Component locations

10	Lights switch on dashboard between steering wheel and driver's door.	267 (H10-3)	Radio connector (10-pin) on the centre console beside the place reserved for the radio.
16	Rheostat, lighting for controls, on dashboard between the steering wheel and driver's door.	282	Switch, headlamp beam adjustment, on dashboard between the steering wheel and driver's door.
18	Lighting, main instrument display panel on dashboard.	386	Switch, electric window lifts and electrically operated sunroof, on the centre console between the seats.
22A	Fuse board behind the cover flap in the glove box.		
25	Switch, hazard flashers, beside centre air vent in dashboard.	449	Switch, TCS ON/OFF, on the dashboard.
47	Main instrument display panel, dashboard.		<i>1-pin connector</i>
48	Cigarette lighter on the centre console beside the ashtray.	H1-4	Under the centre console beside the selector lever.
49	Clock in the centre of the dashboard.		<i>2-pin connector</i>
88	Switch, extra fog lights, on dashboard between the steering wheel and driver's door.	H2-17	Adjacent to the heater control panel.
91	Lighting, selector lever indicator, beside the selector lever in the centre console.	G2	Grounding point on the battery tray.
116	Switch, electrically heated rear window, on control panel for heating and ventilation.	G6	Grounding point, negative distribution terminal, in main fuse box (22B) behind the glove box.
143	Switch, recirculation, on the dashboard between the centre console and steering wheel.	G8	Grounding point, dashboard, by the left-hand front loudspeaker socket.
148	Ashtray lighting, cigarette lighter on centre console.	G14	Grounding point, left-hand seat member, under the front left-hand seat.
154	Lighting, control panel for heating and ventilation on centre console.		
161	Switch, rear fog light, on dashboard between the steering wheel and driver's door.		
169	A/C Switch, on the dashboard between the centre console and steering wheel.		
174	Relay, daylight driving lights, in main fuse box behind the glove box.		
210	EDU trip computer in the main instrument display panel.		
216	ACC control module in the middle of the dashboard.		
241	SCC trip computer in the centre of the dashboard.		
252	Rheostat, driver's seat heating pad, on dashboard between the steering wheel and centre console.		
253	Rheostat, passenger's seat heating pad, on dashboard between the steering wheel and centre console.		

Components

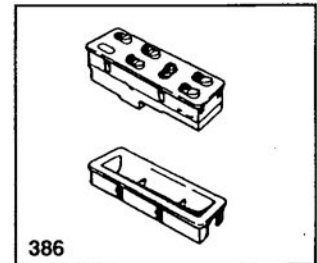
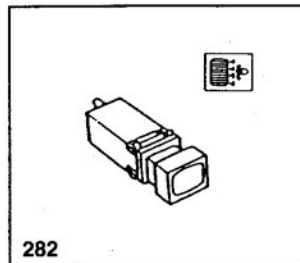
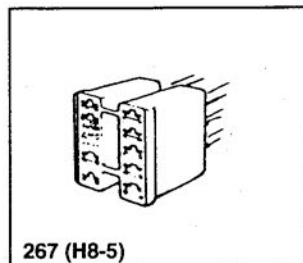
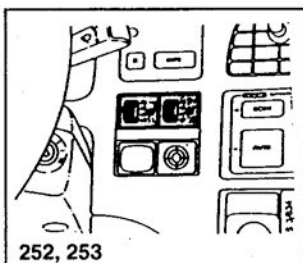
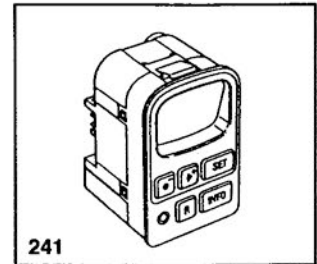
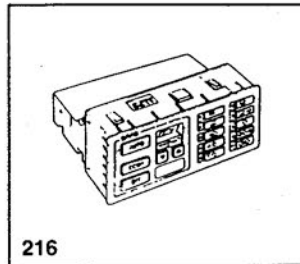
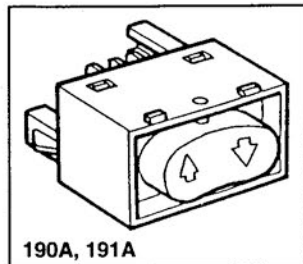
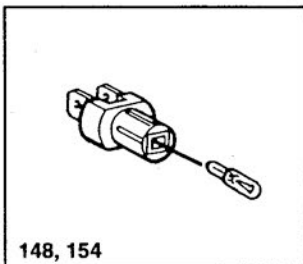
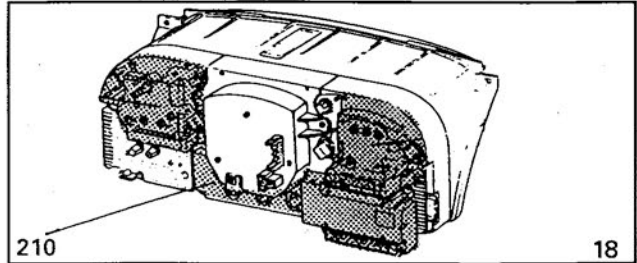
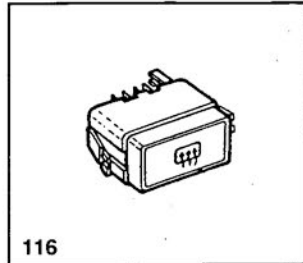
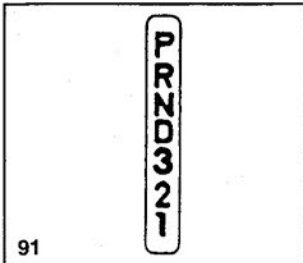
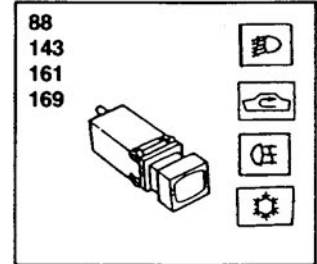
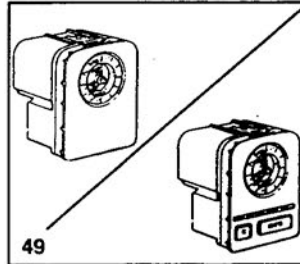
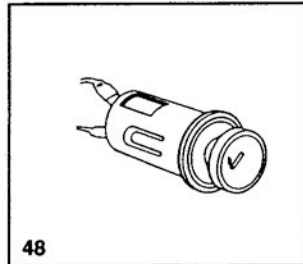
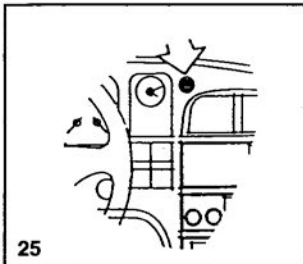
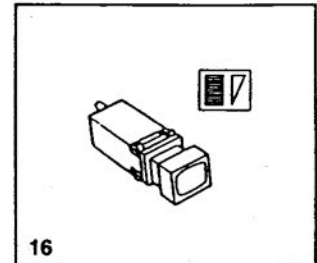
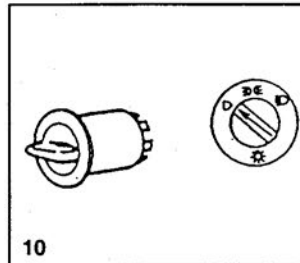
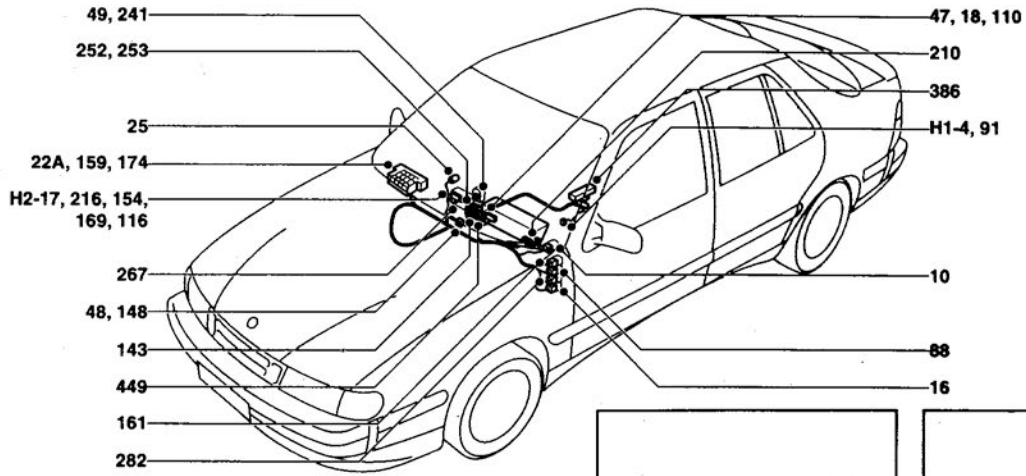

Pre-installed trailer wiring

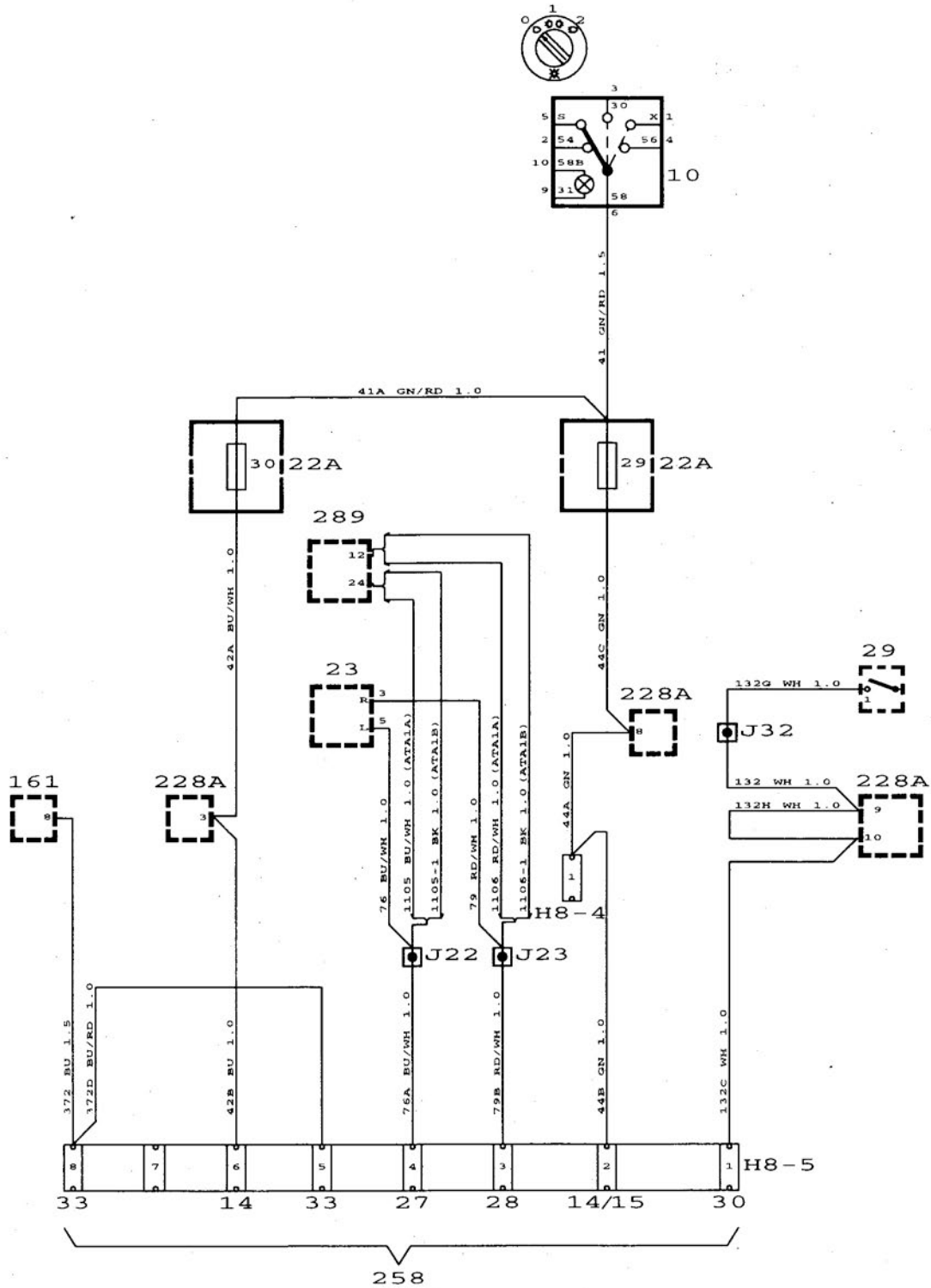

Description of operation

All cars are electrically prepared for the fitting of a towbar. For this purpose, 8-pin connector 258 (H8-5) is provided in the luggage compartment on the left-hand side under the left-hand rear light.

Current is supplied via connector 258 (H8-5) to the following lights on the trailer:

Pin 1	Brake light 30 (from brake light switch 29).
Pin 2	Rear light 14, right-hand side, and number plate lighting 15 (from light switch 10 and fuse 29).
Pin 3	Direction indicators 28, right-hand side (from flasher relay 23).
Pin 4	Direction indicators 27, left-hand side (from flasher relay 23).
Pins 5 and 8	Rear fog light 33 (from switch 161 for rear fog light).
Pin 6	Rear light 14, left-hand side (from light switch 10 and fuse 30).

The grounding cable from the towbar's electrical connector must be connected to rear grounding point G3 on the car, using a separate cable terminal.

Fault diagnosis hints

- 1 Check the electrical connections of the towbar connector, particularly for corrosion.
- 2 Check that current is supplied to all terminals in connector 258 (H8-5).
- 3 Inspect the fuses and wiring harness.

Component locations

- | | |
|---------------|--|
| 10 | Lights switch on dashboard between steering wheel and driver's door. |
| 22A | Fuse board behind the cover flap in the glove box. |
| 23 | Flasher relay in main fuse box behind the glove box. |
| 29 | Brake light switch beside the brake pedal. |
| 161 | Switch, rear fog light, between the steering wheel and driver's door. |
| 228A | Filament monitor, rear lamps, in luggage compartment on the left-hand side. |
| 258
(H8-5) | 8-pin connector for trailer lighting, in luggage compartment below the left-hand light cluster. |
| 289 | Control module, anti-theft alarm, under the dashboard on the right-hand side behind the knee shield.
<i>8-pin connector</i> |
| H8-4 | By the left-hand rear wheel housing. |

Components

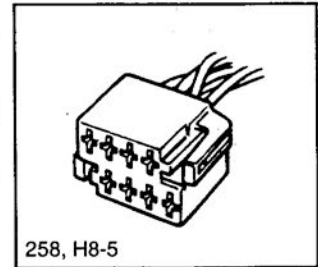
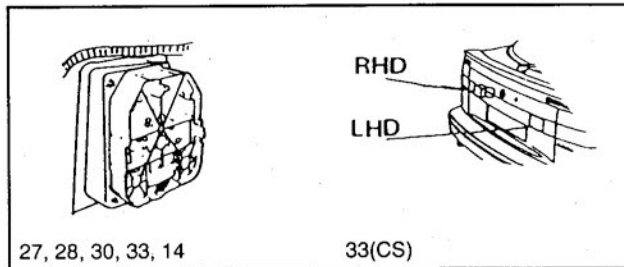
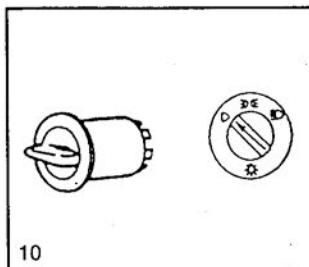
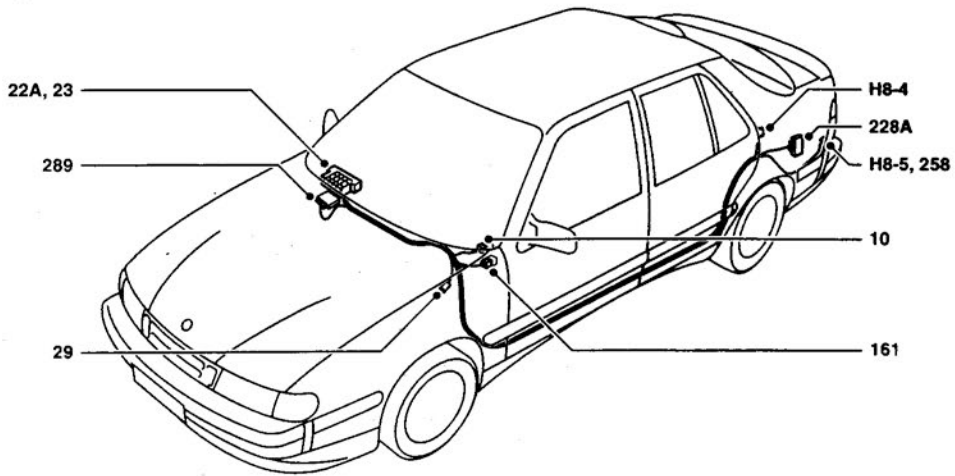

C371W-4530

Description of operation

Windscreen wipers

The car's windscreen wipers can run at two speeds and intermittently. The system also includes windscreen washers.

Current is supplied via fuse 8 to windscreen wiper switch 61, wiper motor terminal 53A, and to relay 83 for intermittent operation.

With switch 61 in position J (intermittent operation), current is supplied from terminal J to the intermittent operation relay, causing it to operate.

The relay contacts close and current flows from terminal 53M to switch terminal 31b, through the switch and on to wiper motor terminal 53. The wiper motor now operates the wipers at regular intervals. The intermittent operation relay controls the time between wipes.

With the switch in position I, current flows from terminal 53 to wiper motor terminal 53 and the motor runs at low speed. This is the same as for position T, but in this position the switch is spring-loaded.

With the switch in position II, current flows from terminal 53b to wiper motor terminal 53b. The motor now runs at high speed.

The wiper motor has an integral mechanically controlled switch. This controls the current so that the wiper motor always returns to the parked position after the current has been cut off with the switch.

This is achieved by the windscreen wiper motor being supplied with current from terminal 53a via the integral rest position switch. The current flows via the rest position switch through the intermittent operation relay and switch and then back to the windscreen wiper motor.

In the wiper's rest position, this contact is broken and as terminals 53 and 53b are then without current, the motor stops.

Washing starts when the stalk switch is moved towards the steering wheel rim (position P). Washer motor 63 is then supplied with current from terminal P of the switch.

If the stalk switch is only moved momentarily towards the steering wheel rim, the wipers automatically wipe four times.

Fault diagnosis hints

Windscreen wipers

- 1 Check that fuse 8 is intact and supplied with current.
- 2 Check the connectors, wiring harness and ground connections.
- 3 Check that the terminals given in the table are supplied with current in the different switch positions:

Position	Terminal on ...			
	Switch 61	Motor 62	Motor 63	Relay 83
0	15	53a		15
J	J,15,31b,53	53,53a,31b		1,15,53M,53S
T	15,31b,53	53,53a,31b		15,53M,53S
I	15,31b,53	53,53a,31b		15,53M,53S
II	15,31b,53b	53a,53b,31b		15,53M,53S
P	P,15,31b,53	53,53a,31 b	1	T,15,53M,53S

Component locations

- 22A Fuse board behind the cover flap in the glove box.
- 61 Switch, windscreen wiper, on the right-hand side of the steering column.
- 62 Windscreen wiper motor, in engine bay on left-hand side (RHD on right-hand side) of bulkhead partition.
- 63 Washer motor, on the washer fluid reservoir in the right-hand wheel housing.
- 83 Relay, intermittent wiper operation, in main fuse box behind the glove box.
- 231 Distribution terminal (+54 circuit) in main fuse box behind the glove box.
2-pin connector
- H2-11 Beside the windscreen wiper motor.
3-pin connector
- H3-5 Beside the windscreen wiper motor.
6-pin connector
- H6-5 In the front right-hand corner behind the light cluster beside the washer fluid reservoir.
24-pin connector
- H24-2 Behind the left-hand headlamp.
- G2 Grounding point, battery tray, on the left-hand wheel housing.
- G6 Grounding point, negative distribution terminal, in main fuse box 22B behind the glove box.
- G31 Grounding point, right-hand structural member behind the right-hand headlamp.

Components

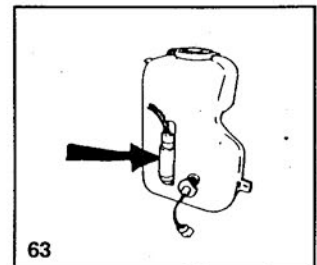
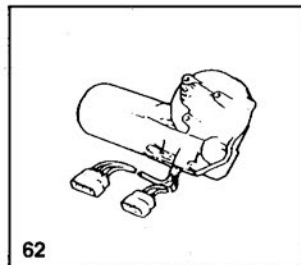
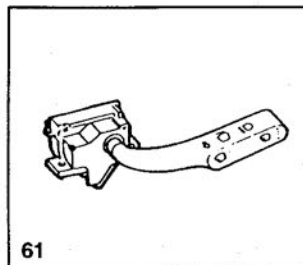
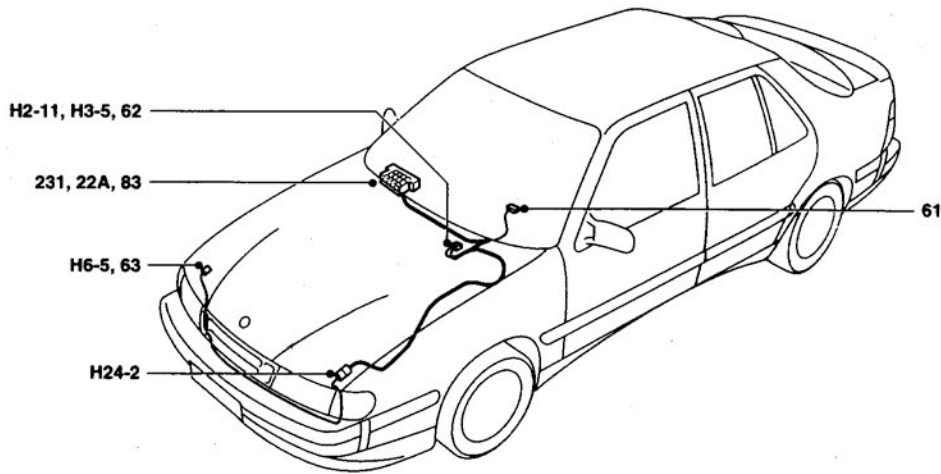

C363W-4531

Headlamp wipers

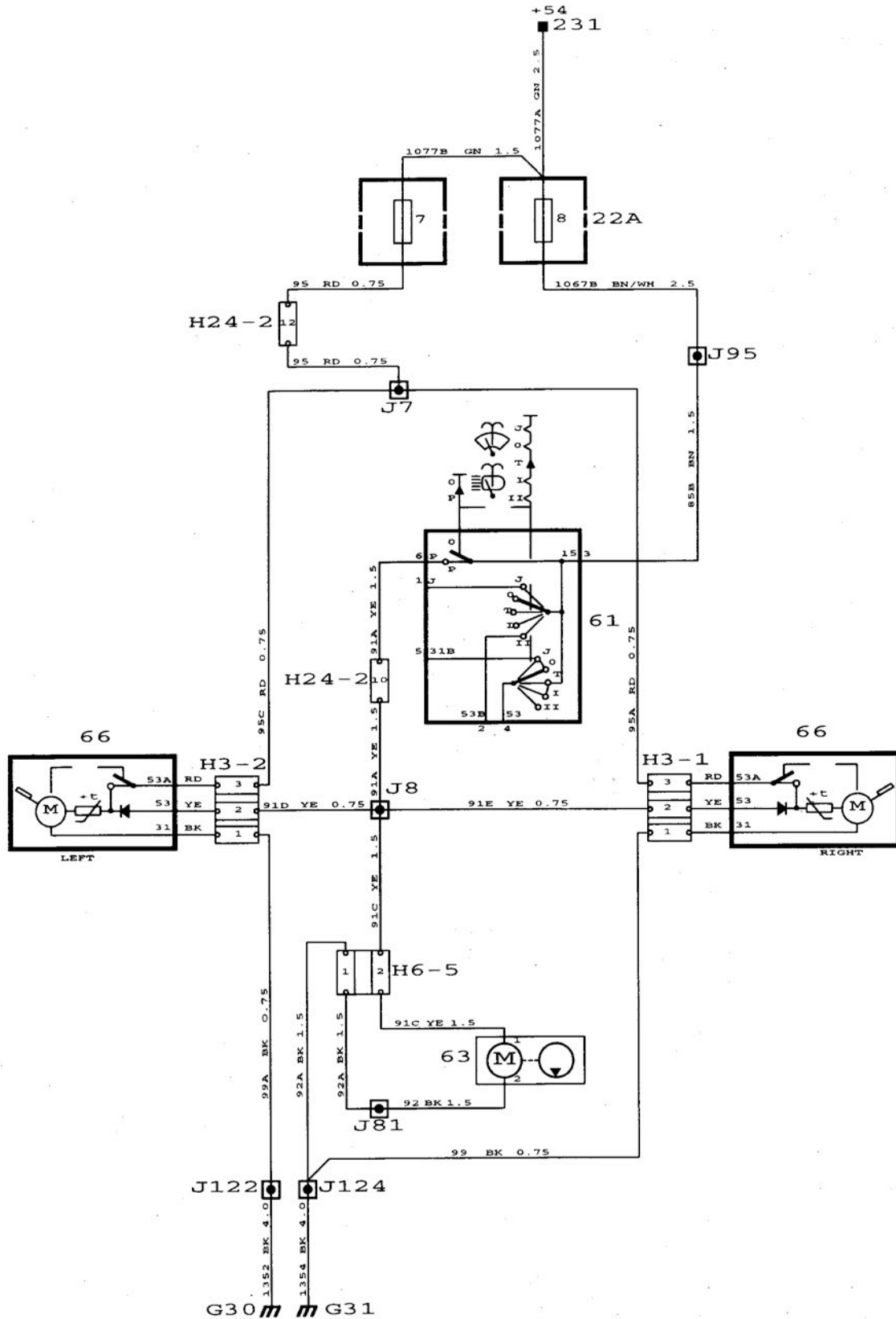

Description of operation

Current is supplied via fuse 7 to each wiper motor 66 and also via fuse 8 to switch 61 for operation of the headlamp wipers.

When the stalk switch is moved towards the steering wheel rim (position P), motors 66 for the headlamp wipers and washer motor 63 start simultaneously.

When the stalk is released, breaking the circuit, the wiper motors are still supplied with current via fuse 7. When the wiper motors have completed a cycle of five strokes, their integral limit switch breaks the circuit and the wipers stop in the parked position.

A diode in each motor prevents current from the motor feedback circuit from flowing back to the washer motor.

Each wiper motor is internally protected against overload with a circuit breaker actuated by a PTC resistor. The circuit breaker is connected in series with the motor and trips if the load becomes excessive, as might happen if the wiper blades are frozen to the headlamp lenses, for instance.

Fault diagnosis hints

Check with switch 61 in position 0.

- 1 Check that fuses 7 and 8 are intact and supplied with current.
- 2 Check that switch terminal 15 is supplied with current.
- 3 Check the connectors, wiring harness and ground connections.

Component locations

- 22A Fuse board behind the cover flap in the glove box.
- 61 Switch, windscreen wiper, on the right-hand side of the steering column.
- 63 Washer motor, on the washer fluid reservoir in the right-hand wheel housing.
- 66 Headlamp wiper motors, behind each headlamp.
- 231 Distribution terminal (+54 circuit) in main fuse box behind the glove box.
- 3-pin connectors*
- H3-1 Behind the right-hand headlamp wiper.
- H3-2 Behind the left-hand headlamp wiper.
- 6-pin connector*
- H6-5 In the front right-hand corner behind the light cluster beside the washer fluid reservoir.
- 24-pin connector*
- H24-2 Behind the left-hand headlamp.
- G30 Grounding point, left-hand structural member behind the left-hand headlamp.
- G31 Grounding point, right-hand structural member behind the right-hand headlamp.

Components

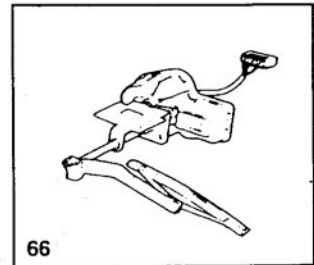
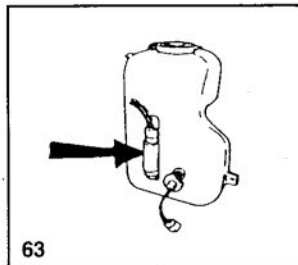
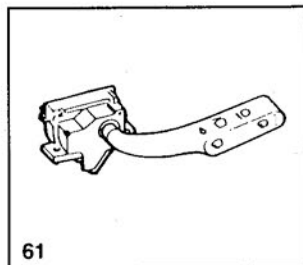
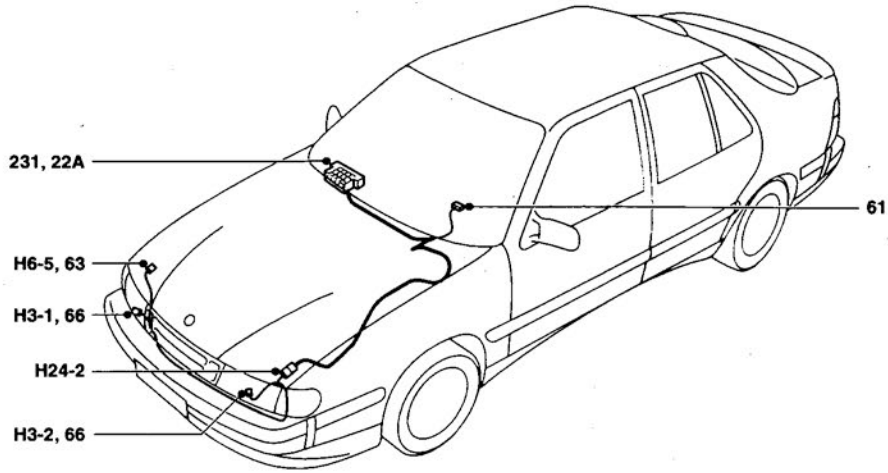

C363W-4532

Headlamp beam adjustment

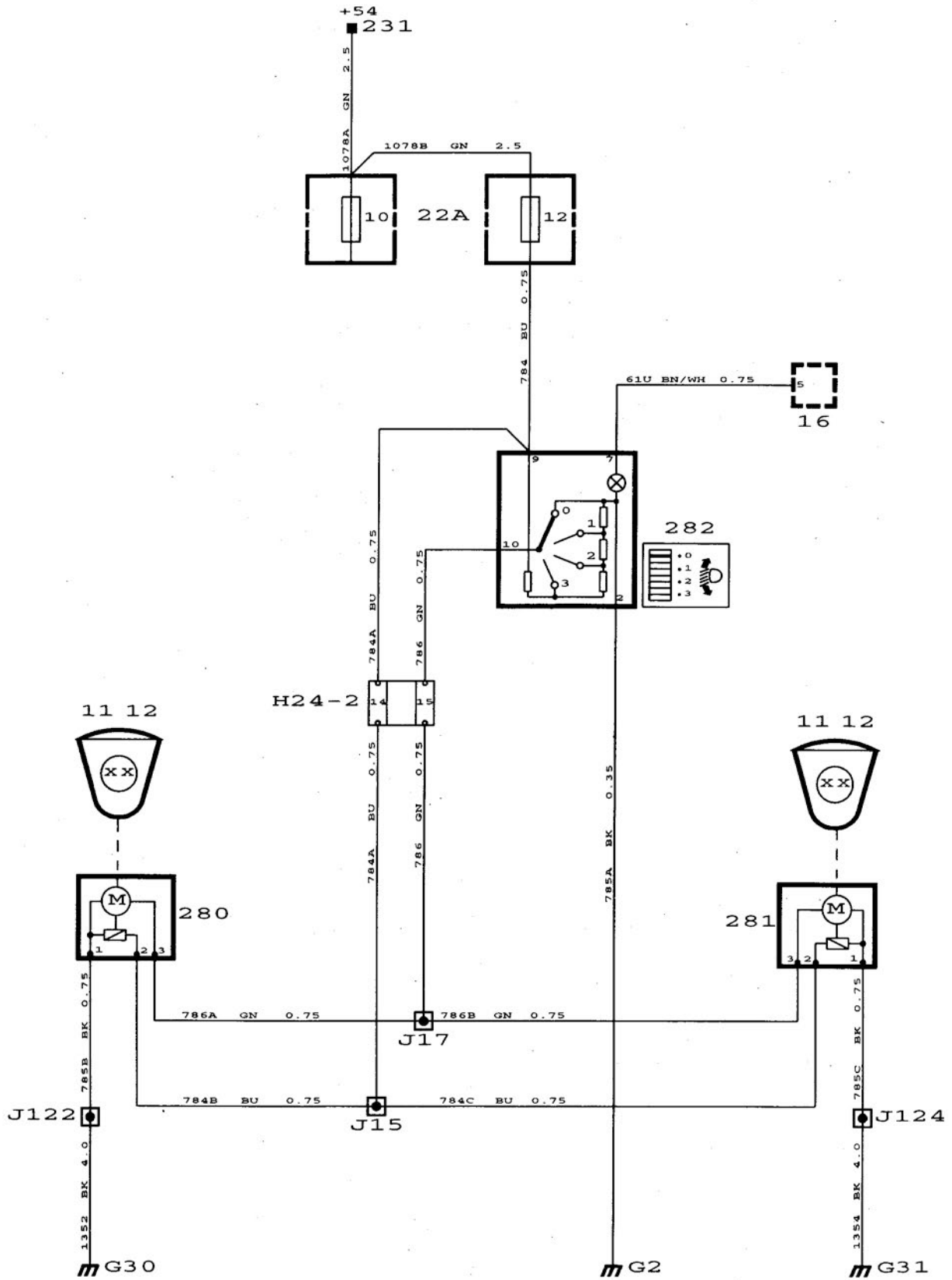

Description of operation

Headlamp beam adjustment

Some models for certain markets are equipped with a headlamp beam adjustment system. The driver can adjust the setting of the headlamps using the switch on the dashboard. This avoids dazzling the drivers of other vehicles when the car is heavily loaded.

With the ignition switch in the Drive position, current is supplied to terminal 9 on light switch 282 via fuse 12.

With the switch in position 0, the headlamps are at their normal setting. When the switch is turned to position 1, electric motors 280 and 281 are supplied with current and rotate a number of turns (stepping motors). These motors actuate the setting screws and the setting of the headlamps is lowered. When the switch is turned to positions 2 and 3, the setting is lowered a further two steps.

The beam setting is raised in steps in the same way, 3-2-1-0.

Fault diagnosis hints

Headlamp beam adjustment

The headlamp beam adjustment system will be operative when the ignition switch is in the Drive position.

- 1 Check that fuse 12 is intact and supplied with current.
- 2 Check that current is supplied to switch 282.
- 3 Check, by activating the switch, that current is supplied to motors 280 and 281.
- 4 Check the connectors, wiring harness and ground connections.

Component locations

- 11 Full beam in LH and RH headlamps.
- 12 Dipped beam in LH and RH headlamps.
- 16 Rheostat, instrument lighting, on dashboard between the steering wheel and driver's door.
- 22A Fuse board behind the cover flap in the glove box.
- 231 Distribution terminal (+54 circuit) in main fuse box behind the glove box.
- 280 Motor, headlamp beam adjustment, adjacent to the left-hand headlamp.
- 281 Motor, headlamp beam adjustment, adjacent to the right-hand headlamp.
- 282 Switch, headlamp beam adjustment, on dashboard between the steering wheel and driver's door.
24-pin connector
- H24-2 Behind the left-hand headlamp.
- G2 Grounding point, battery tray, on the left-hand wheel housing.
- G30 Grounding point, left-hand structural member behind the left-hand headlamp.
- G31 Grounding point, right-hand structural member behind the right-hand headlamp.

Components

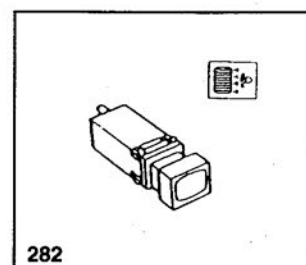
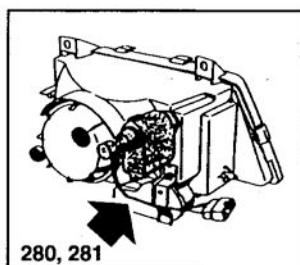
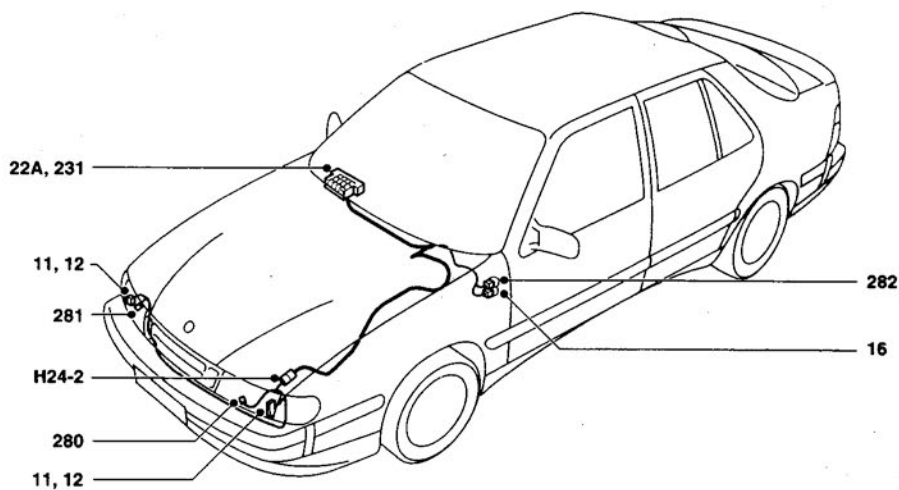

C351W-4533

Rear window wiper CS

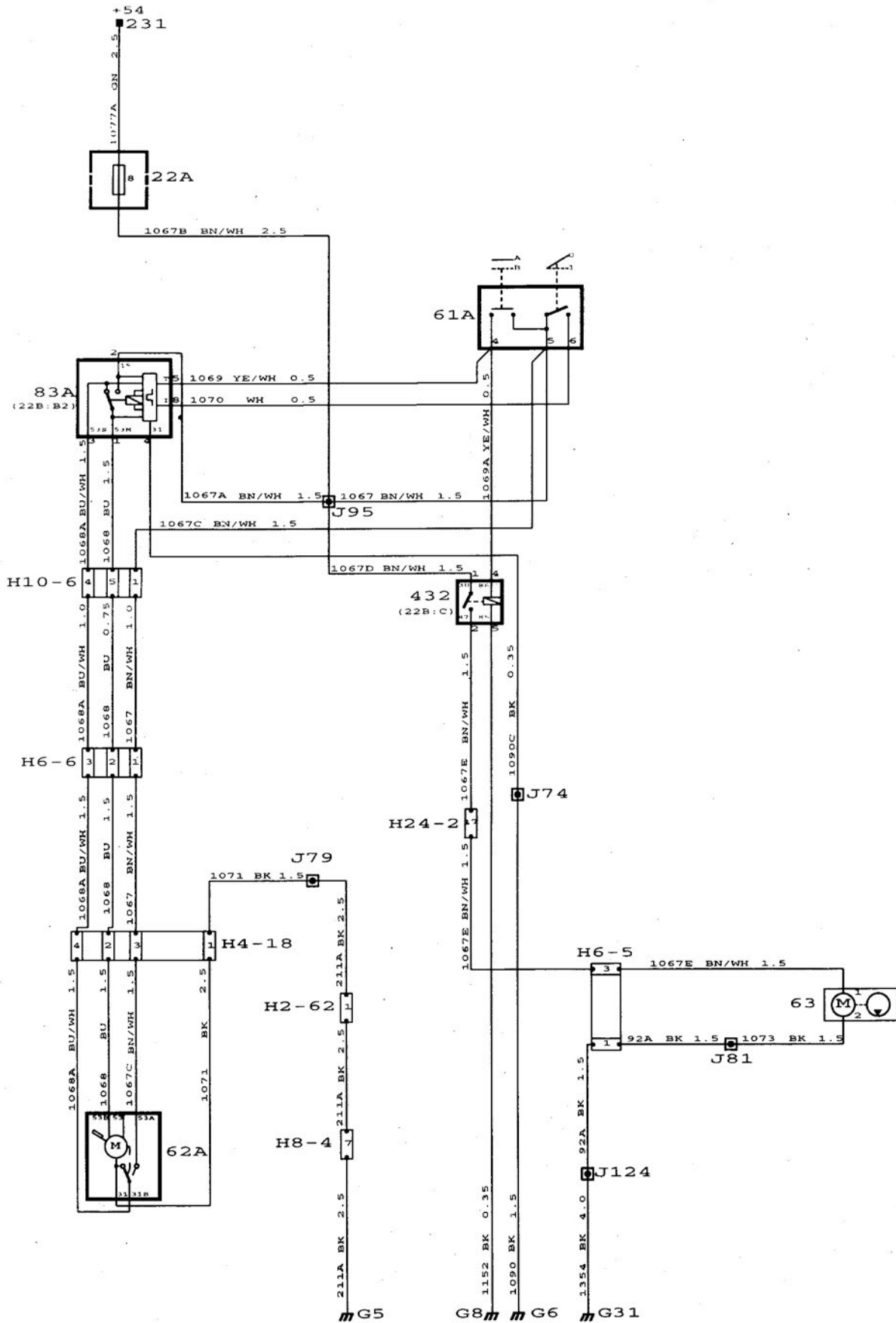

Description of operation

Only the CS model is fitted with a rear window wiper. Current is supplied via fuse 8 to rear window wiper switch 61A, rear window washer relay 432 and to terminal 53A of rear window wiper motor 62A.

When switch 61A is in position 1, current is supplied from terminal 6 of the switch to the intermittent operation relay which then operates. The relay contacts close and current flows from terminal 53M to wiper motor terminal 53b. The wiper motor now runs at regular intervals. The intermittent operation relay controls the interval between wipes.

The wiper motor incorporates a mechanically actuated switch which controls the supply of current so that the motor always returns the wiper to the parked position after the circuit has been broken by the switch.

This is achieved by supplying the wiper motor with current from terminal 53a via the integral rest position switch. The current flows via the rest position switch, through the intermittent operation relay and then back to the rear window wiper motor.

When the wiper is in the rest position this circuit will be broken and if terminal 53b is then without current the motor will stop.

Washing starts when the spring-loaded button marked with the washer symbol is pressed (position B). Rear window washer relay 432 is then supplied with current from terminal 4. The relay operates and washer motor 63 is supplied with current from terminal 87 of the relay.

The intermittent operation relay is also supplied with current via terminal T and the rear window wiper runs at the same time as the rear window is being washed.

Fault diagnosis hints

The rear window wiper will be operative when the ignition switch is in the Drive position.

- 1 Check that fuse 8 is intact and supplied with current.
- 2 Check the connectors, wiring harness and ground connections.
- 3 Check that the terminals given in the table are supplied with current in the different switch positions:

Position	Terminal on ...				
	61A	62A	63	83	432
0	5	53A		15	30
1	5,6	53a,53b, 31b		1,15,53M, 53S	30
A	5	53a		15	30
B	4,5	53a,53b, 31b	1	T,15,53M, 53S	86,87,30

Component locations

22A	Fuse board behind the cover flap in the glove box.
61A	Switch, rear window wiper, on the windscreen wiper stalk switch on the right-hand side of the steering column.
62A	Motor, rear window wiper, in the tailgate beside the window
63	Washer motor, on the washer fluid reservoir in the right-hand wheel housing.
83A	Relay, intermittent wiper operation, in main fuse box behind the glove box.
231	Distribution terminal (+54 circuit) in main fuse box behind the glove box.
432	Relay, rear window washer, in main fuse box behind the glove box. <i>2-pin connector</i>
H2-62	In the tailgate on the left-hand side. <i>4-pin connector</i>
H4-18	Beside the rear window wiper motor. <i>6-pin connectors</i>
H6-5	In the front right-hand corner behind the light cluster beside the washer fluid reservoir.
H6-6	To the right of the rear window wiper. <i>8-pin connector</i>
H8-4	By the left-hand rear wheel housing. <i>10-pin connector</i>
H10-6	By the left-hand rear wheel housing. <i>24-pin connector</i>
H24-2	Behind the left-hand headlamp.
G5	Under the left-hand rear seat.
G6	Grounding point, negative distribution terminal, in main fuse box 22B behind the glove box.
G8	Grounding point, dashboard, by the left-hand front loudspeaker socket.
G31	Grounding point, right-hand structural member behind the right-hand headlamp.

Components

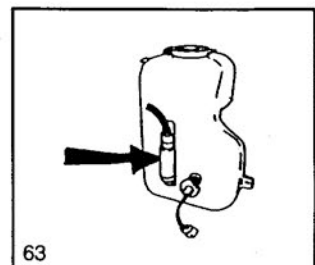
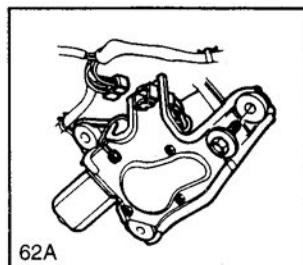
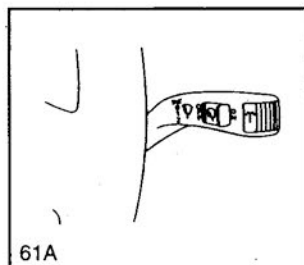
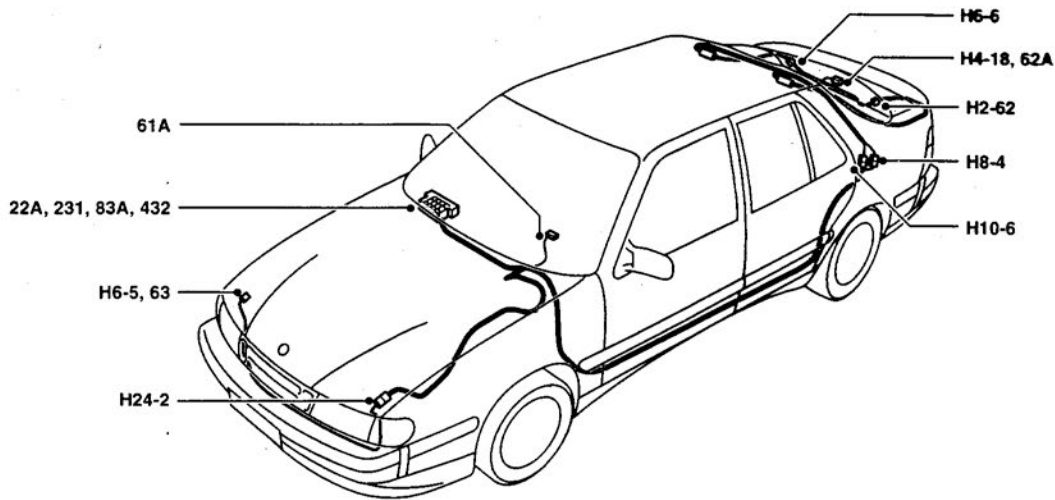

C363W-4534

Tachometer unit

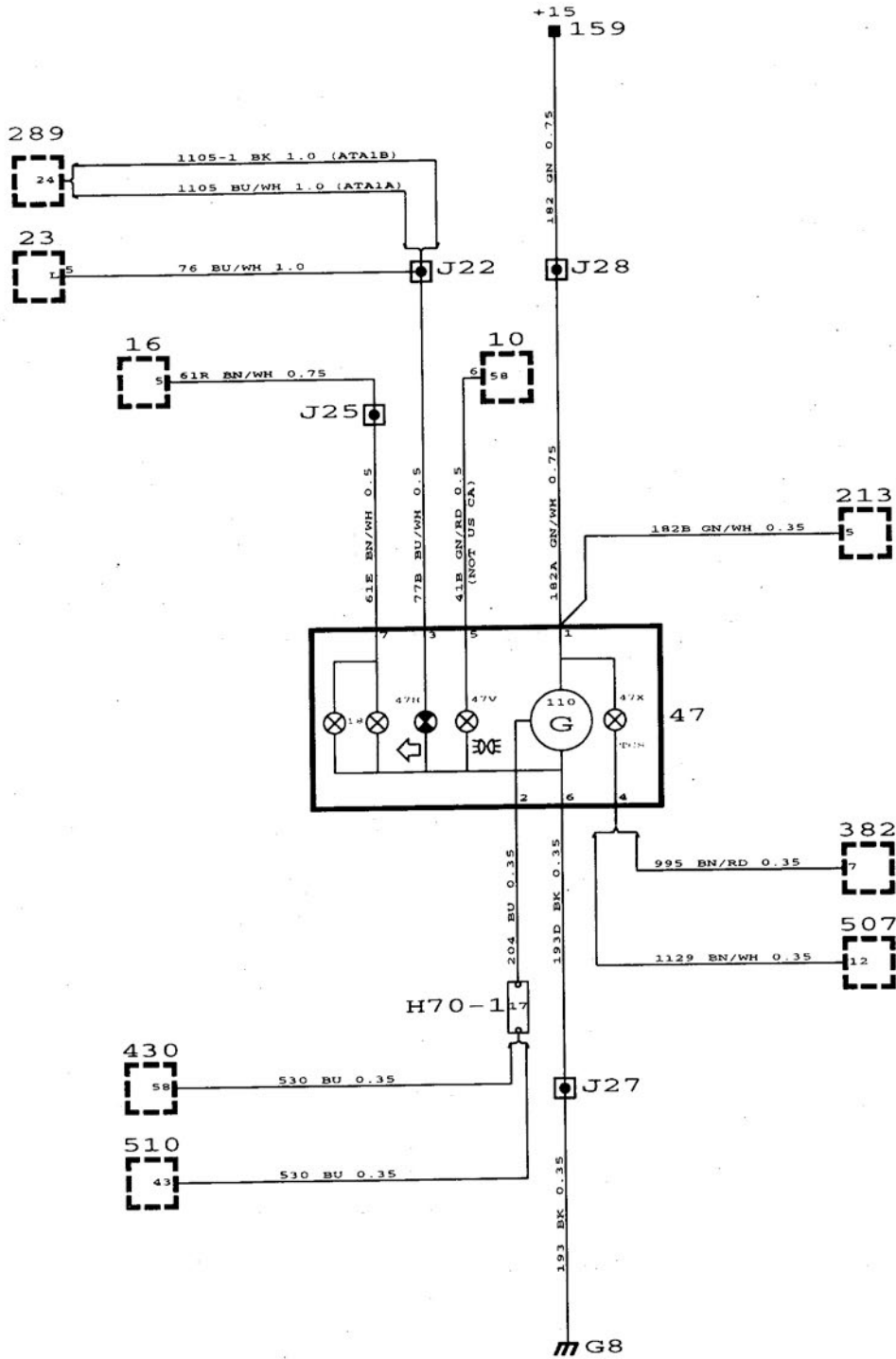

ATA1A = US/CA

ATA1B = SE/EU/GB/ME/PA/LA/AU

Description of operation

Tachometer (rev counter) 110

Tachometer 110 in main instrument display panel 47 is supplied with current via fuse 13 and pin 1. The control pulses needed by the tachometer to show engine rpm are obtained from control module 430 or 510 via pin 2. The tachometer is connected to ground via pin 6.

Instrument lighting 18

Background lighting of the instruments is controlled from rheostat 16 (lighting for controls) via pin 5 and the lamps are connected to ground via pin 6.

Indicator lamp 47H

The indicator lamp for the left-hand direction indicators is controlled from flasher relay 23 via pin 3 and connected to ground via pin 6.

Indicator lamp, lights on, 47V

An indicator lamp that shows when the parking lights are on is fitted on cars for certain markets.

With the ignition switch in the Drive position, current is supplied via lights switch 10 to pin 5 and to one of the poles on 47V. The lamp's other pole is connected to ground via pin 6.

Indicator lamp 47X

The lamp is supplied with positive current on pin 1 via fuse 13. When pin 4 of the lamp is grounded, either via ABS-TC control module 382 or TTS control module 507, the lamp lights up.

Fault diagnosis hints

- 1 Check that fuse 13 is intact and supplied with current.
- 2 Check the connectors, wiring harness and ground connections.

The lights-on indicator lamp is activated when lights switch 10 is turned to position 1 or 2.

- 1 Check that the lights switch is supplied with current.
- 2 Check that the bulb is OK and that current is supplied to the card for the warning and indicator lamps and also to the tachometer.
- 3 Check the connectors, wiring harness and ground connections.

Component locations

- 10 Lights switch on dashboard between steering wheel and driver's door.
- 16 Rheostat, lighting for controls, on dashboard between the steering wheel and driver's door.
- 23 Flasher relay, on the relay board behind the glove box.
- in the main instrument display panel:*
- 18 Instrument lighting
- 47H Indicator lamp, left-hand direction indicators.
- 47V Indicator lamp, lights on (EU).
- 47X TCS (anti-spin) indicator lamp.
- 110 Tachometer (rev counter)
- 159 Distribution terminal (+15 circuit) in main fuse box behind the glove box.
- 213 Pictogram, in the main instrument display panel.
- 289 Anti-theft alarm control module, on the right-hand side below the dashboard behind the knee shield.
- 382 ABS-TC control module on the battery tray
- 430 Saab Trionic control module, in engine bay on the left behind the bulkhead partition.
- 507 TCS V6 control module, under the left-hand front seat.
- 510 Motronic 2.8.1 control module, in the engine bay behind the bulkhead partition.
- 70-pin connector*
- H70-1 In the engine bay, behind the bulkhead partition.
- G8 Grounding point, dashboard, by the left-hand front loudspeaker socket.

Components

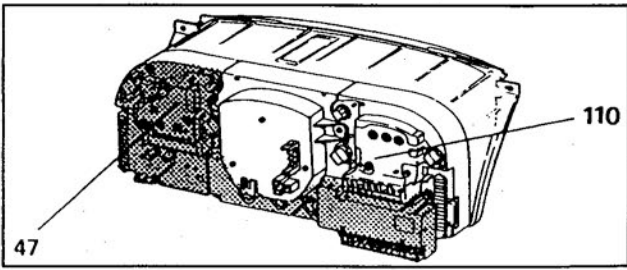
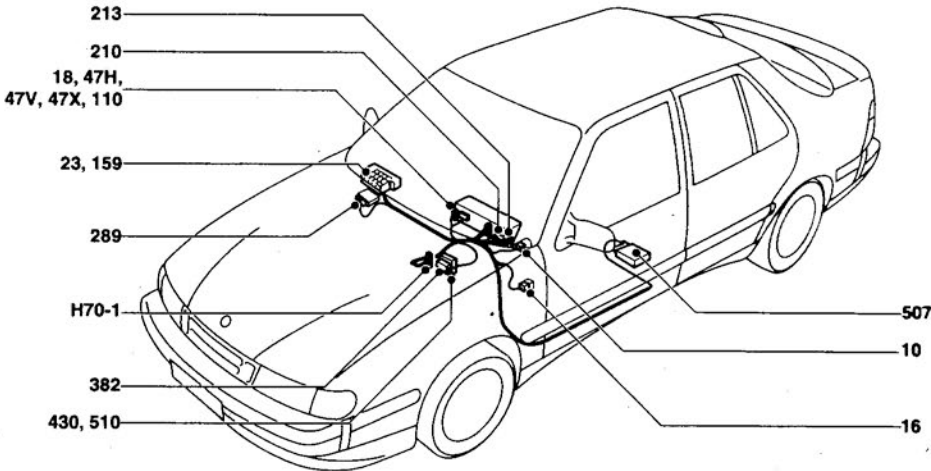

C381W-4535

Coolant temperature gauge

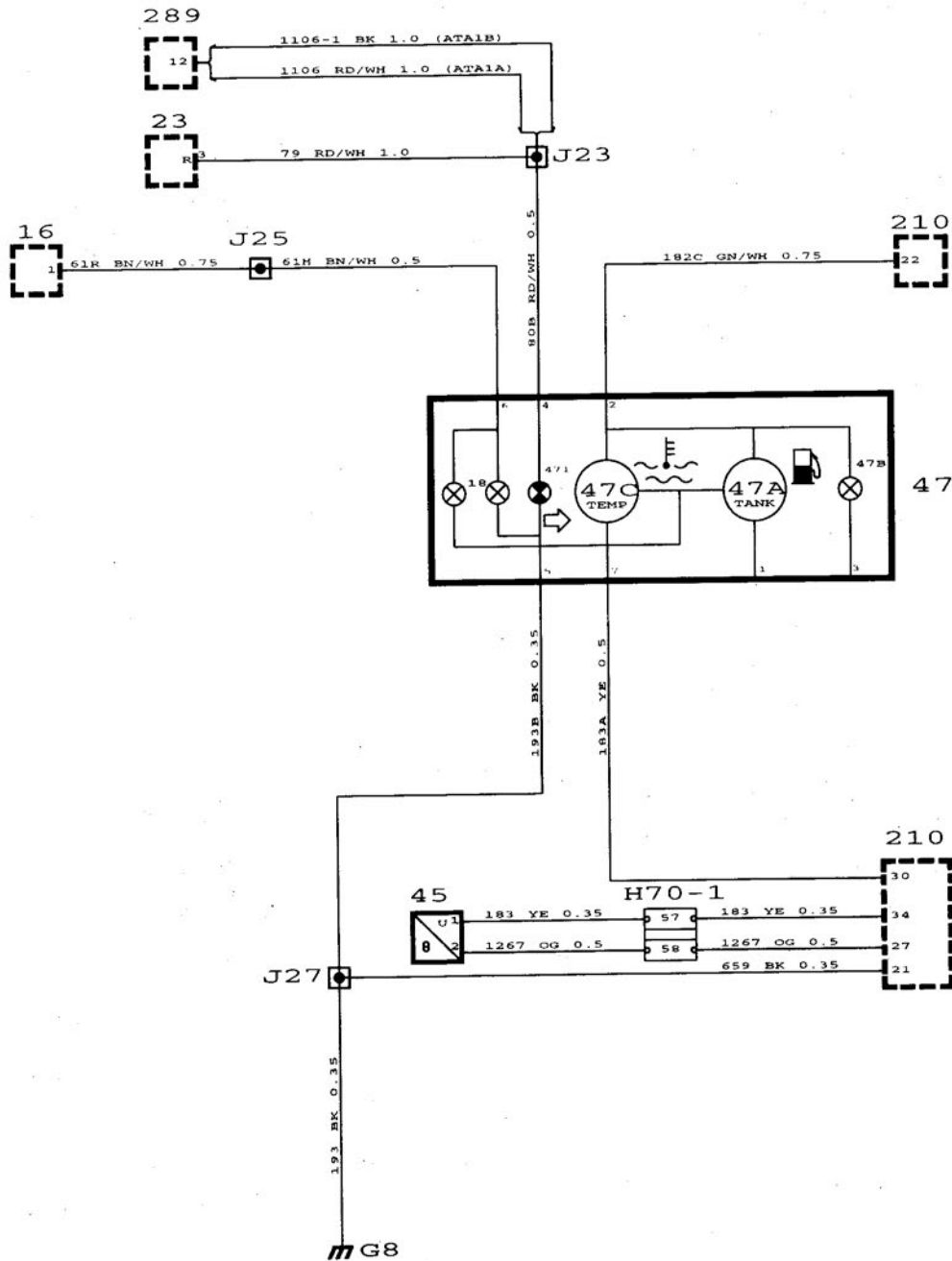

ATA1A = US/CA
 ATA1B = SE/EU/GB/ME/PA/LA/AU

Description of operation

Coolant temperature gauge 47C

The temperature gauge displays the temperature of the engine coolant.

When the ignition switch is in the Drive position, 12 V is supplied to pin 2 of the temperature gauge from pin 22 of EDU 210. Engine coolant temperature sensor 45 is connected to the EDU which, after processing the information, sends a signal of 1-9 V to pin 7 of the tank/temperature unit.

1 V = min. temperature.

9 V = max. temperature.

Temperature gauge 47C, fuel gauge 47A, instrument lighting lamps 18, and indicator lamp 47I are connected to ground via pin 5.

Instrument lighting 18

Backlighting of the instruments is controlled by rheostat 16 (lighting for controls) via pin 6.

Indicator lamp 47I

The indicator lamp for the right-hand direction indicators is controlled by flasher relay 23 via pin 4.

Fault diagnosis hints

The temperature gauge is activated when the ignition switch is turned to the Drive position.

- 1 Check that current is supplied to pin 2.
- 2 Check that current is supplied to pin 22 of EDU 210.
- 3 Check that 1-9 V is applied to pin 7.
- 4 Check the connectors, wiring harness and ground connections.

For fault diagnosis of the EDU system, see Service Manual 3:5 **EDU programmable trip computer**.

Component locations

- 16 Rheostat, lighting for controls, on dashboard between the steering wheel and driver's door.
- 18 Lighting in the main instrument display panel.
- 23 Flasher relay in main fuse box behind the glove box.
- 45 Engine coolant temperature sensor, on the left-hand side of the thermostat housing.
- in the main instrument display panel*
- 47A Fuel gauge.
- 47B Indicator lamp for low fuel level.
- 47C Coolant temperature gauge
- 47I Indicator lamp, right-hand direction indicators.
- 210 EDU trip computer in the main instrument display panel.
- 289 Anti-theft alarm control module, under dashboard on the right behind the knee shield.
- 70-pin connector*
- H70-1 In the engine bay, behind the bulkhead partition.
- G8 Grounding point, dashboard, by the left-hand front loudspeaker socket.

Components

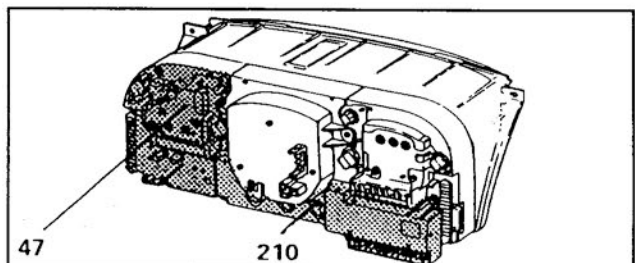
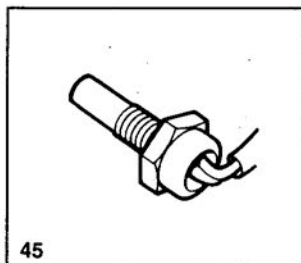
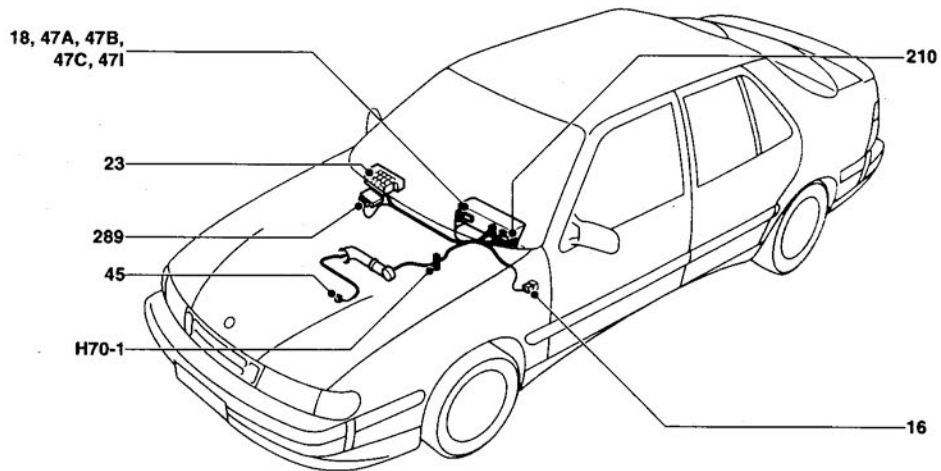

C381W-4536

Fuel gauge

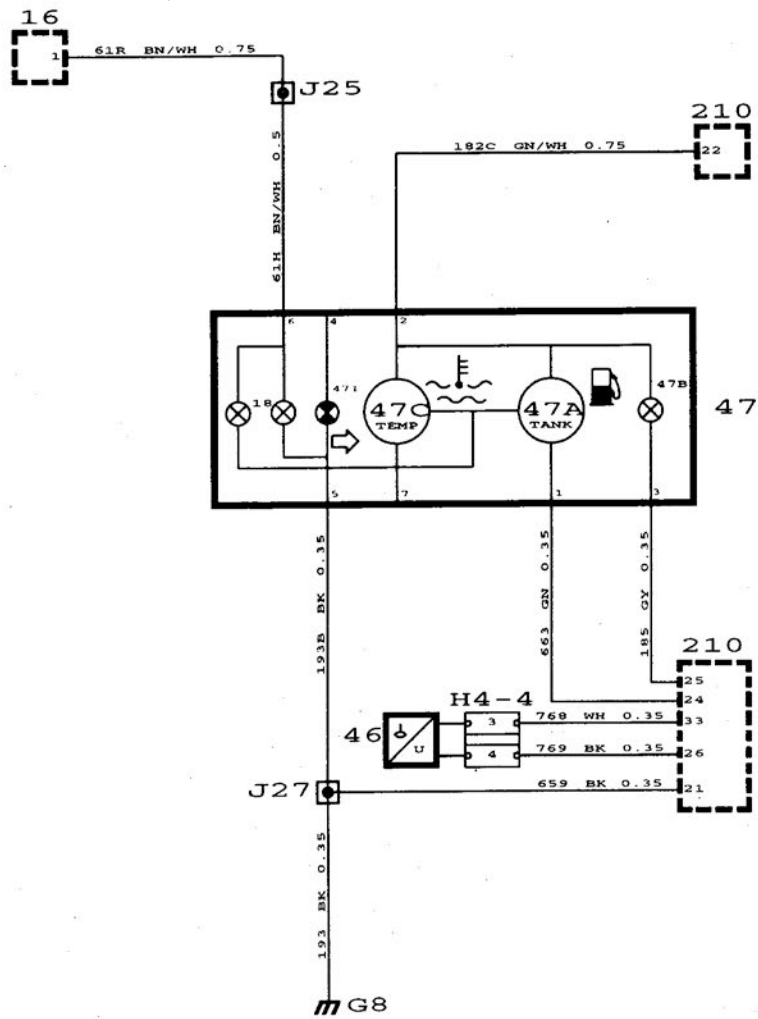

Description of operation

Fuel level sensor 46

The fuel level sensor is integrated into the fuel pump.

Fuel gauge 47A

When the ignition switch is in the Drive position, 12 V is supplied to pin 2 of the temperature instrument from pin 22 of EDU 210. Fuel level sensor 46 is connected to the EDU which, after processing the information, sends a 1-9 V signal to pin 1 of the tank/temperature unit.

1 V = tank empty.

9 V = tank full.

Temperature gauge 47C, fuel gauge 47A, instrument lighting lamps 18, and indicator lamp 47I are connected to ground via pin 5.

Instrument lighting 18

Backlighting of the instruments is controlled by rheostat 16 (lighting for controls) via pin 6.

Indicator lamp 47I

The indicator lamp for the right-hand direction indicators is controlled by flasher relay 23 via pin 4.

Pilot lamp 47B

Fuel warning lamp 47B is controlled by EDU 210. When the fuel level in the tank drops below 10 l, the lamp is grounded via pin 3.

Fault diagnosis hints

Fuel gauge

The fuel gauge is activated when the ignition switch is turned to the Drive position.

- 1 Check that current is supplied to pin 2.
- 2 Check that current is supplied to pin 22 of EDU 210.
- 3 Check that 1-9 V is applied to pin 1.
- 4 Check the connectors, wiring harness and ground connections.

Fuel warning lamp

The fuel warning lamp lights up for 4 seconds when the ignition switch is turned to the Drive position, provided that there is more than 10 litres of fuel in the tank.

For fault diagnosis of the EDU system, see Service Manual 3:5 **EDU programmable trip computer**.

Component locations

- 16 Rheostat, lighting for controls, on dashboard between the steering wheel and driver's door.
- 23 Relay, direction indicators, in main fuse box behind the glove box.
- 46 Fuel level sensor, in fuel tank under the luggage compartment floor.

in the main instrument display panel:

- 18 Lighting for instruments.
- 47A Fuel gauge
- 47B Indicator lamp for low fuel level.
- 47C Coolant temperature gauge.
- 47I Indicator lamp, right-hand direction indicators.
- 110 Tachometer (rev counter).
- 210 EDU trip computer in the main instrument display panel.
- 289 Anti-theft alarm control module, under dashboard on the right-hand side behind the knee shield.

4-pin connector

- H4-4 Beside the fuel pump under the luggage compartment floor.
- G8 Grounding point, dashboard, by the left-hand front loudspeaker socket.

Components

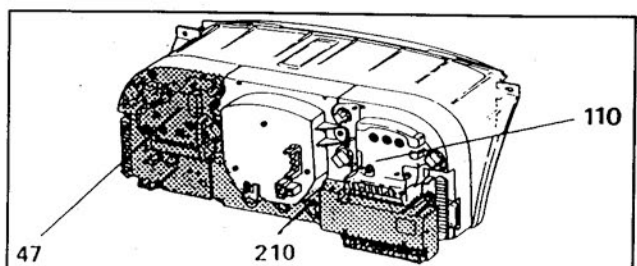
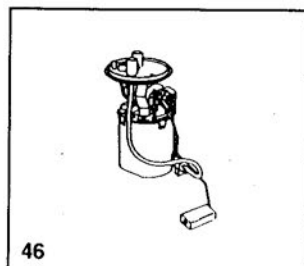
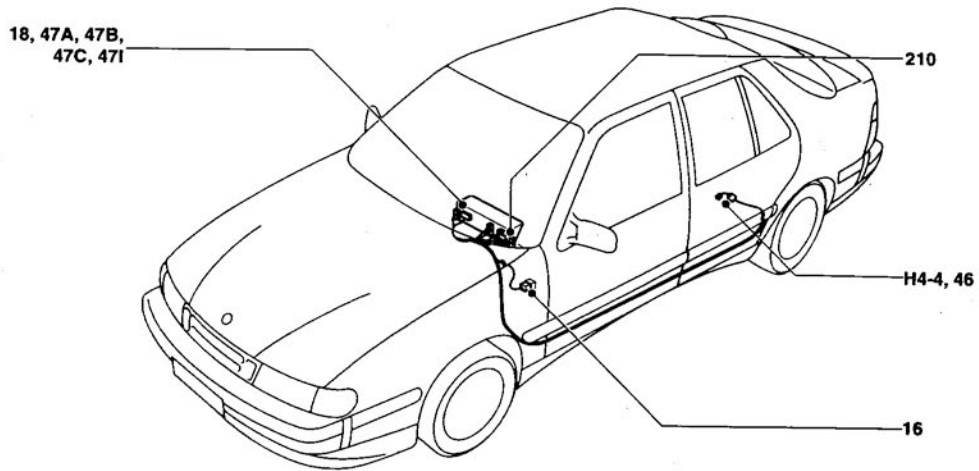

C:3R1W-4527

Speedometer without buzzer

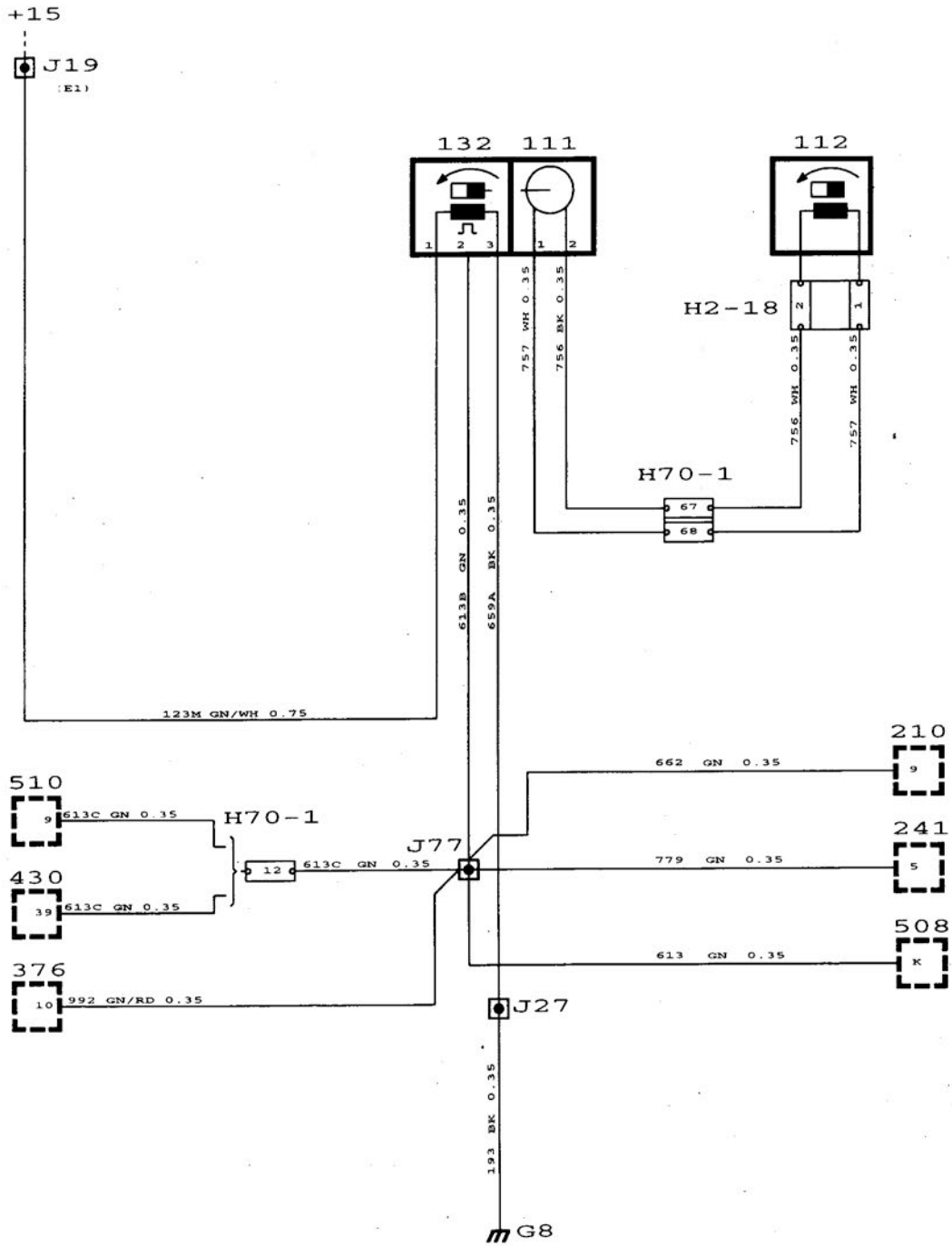

Speedometer with buzzer

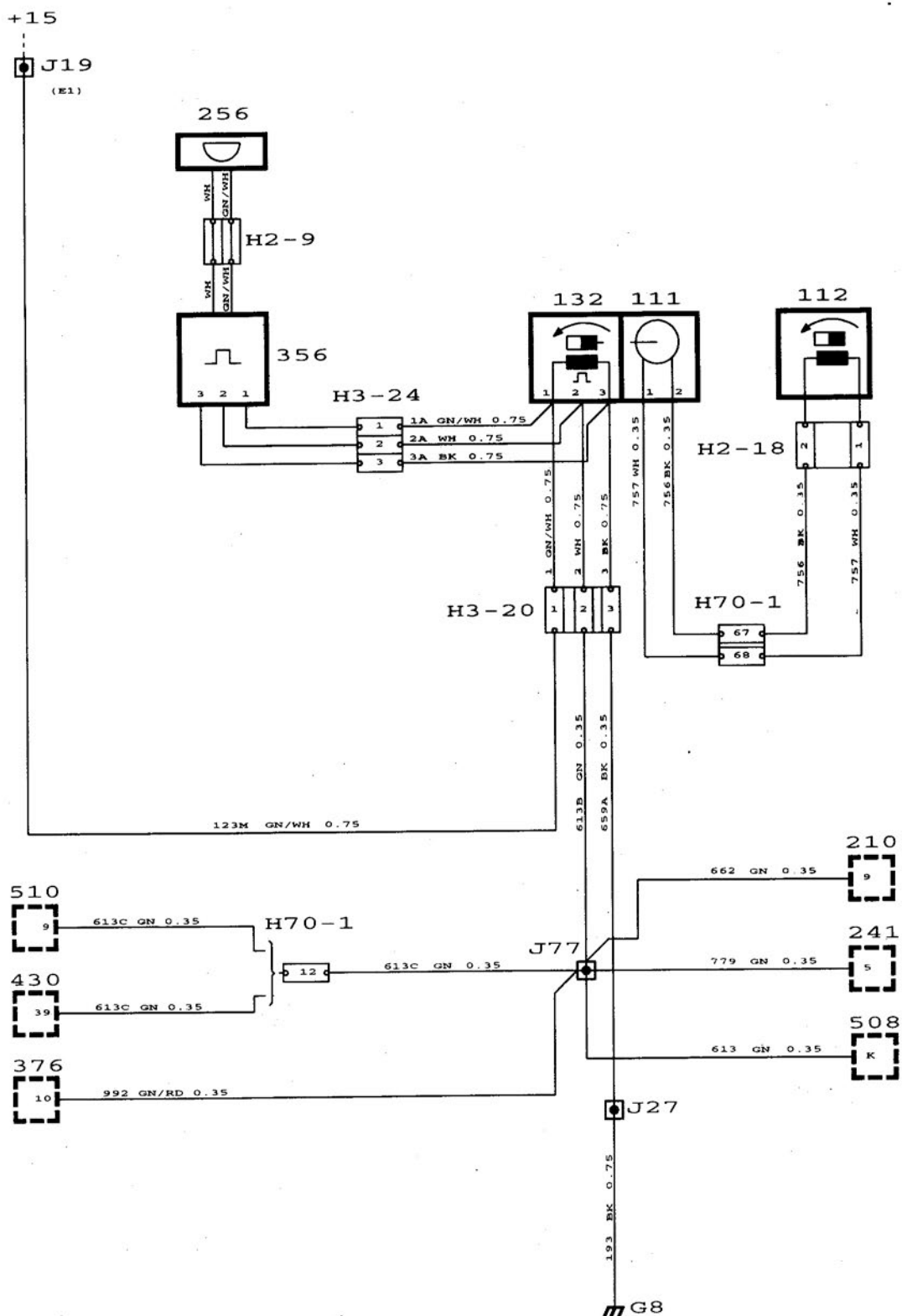

Description of operation

Without buzzer

The car is fitted with an electronic speedometer. Transmission between the gearbox and the speedometer is electronic.

When ignition switch 20 is in the Drive position, current is supplied to pin 1 of the sensor, vehicle speed sensor 132, which sends a pulsed signal to the Cruise Control and speed warning systems, as well as to other systems.

The pulse frequency is 2,458 pulses per kilometre.

Vehicle speed sensor 112 is mounted in the gearbox. It transmits an alternating current, the frequency of which varies with the speed of the car, to electronic speedometer 111 in the main instrument display panel. The pulse frequency of VSS 112 is four times that of VSS 132.

With buzzer

In certain markets, the speedometer incorporates speed warning buzzer 256 and speed warning control module 356.

Fault diagnosis hints

- 1 Check that current is supplied to pin 1 of the speed sensor.
- 2 Check that there is no open circuit in sensor 112.
- 3 Check the connectors, wiring harness and ground connections.

Component locations

- 111 Electronic speedometer in the main instrument display panel.
- 112 Sensor, electronic speedometer, on the gearbox.
- 132 Vehicle speed sensor, in the speedometer.
- 210 EDU trip computer in the main instrument display panel.
- 241 SCC trip computer in the centre of the dashboard.
- 256 Speed warning buzzer, in the centre console's bottom storage compartment.
- 356 Speed warning control module, at the rear of the bottom storage compartment in the centre console.
- 376 ETS throttle control module, under left-hand front seat.
- 430 Saab Trionic control module, in engine bay on the left-hand side of the bulkhead partition.
- 508 Control module, Cruise Control system, adjacent to the battery tray.
- 510 Control module, Motronic 2.8.1, in engine bay behind the bulkhead partition.
- 2-pin connectors*
- H2-9 In the centre console under the front ashtray.
- H2-18 In the engine bay behind the engine under the intake manifold.
- 3-pin connectors*
- H3-20 Behind the main instrument display panel adjacent to the speedometer (ME).
- H3-24 Adjacent to speed warning control module 356.
- 70-pin connector*
- H70-1 In the engine bay, behind the bulkhead partition.
- G8 Grounding point, dashboard, beside the front left-hand speaker socket.

Components

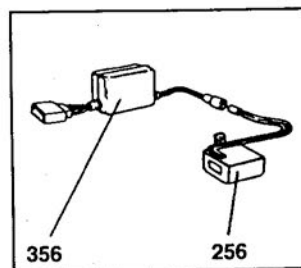
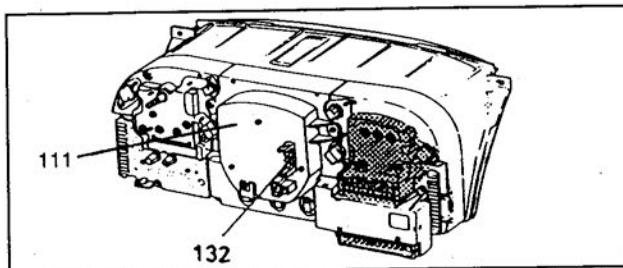
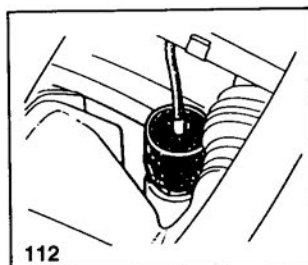
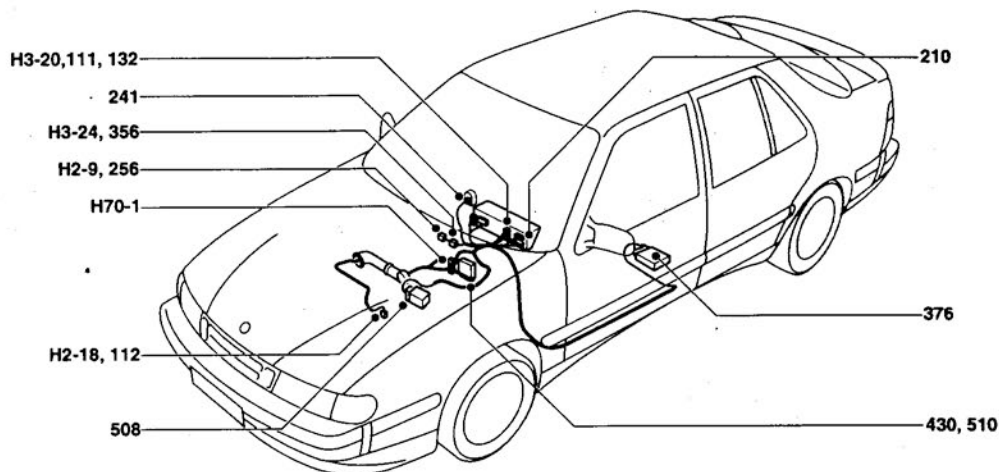

C381W-4538

EDU 3 trip computer and clock

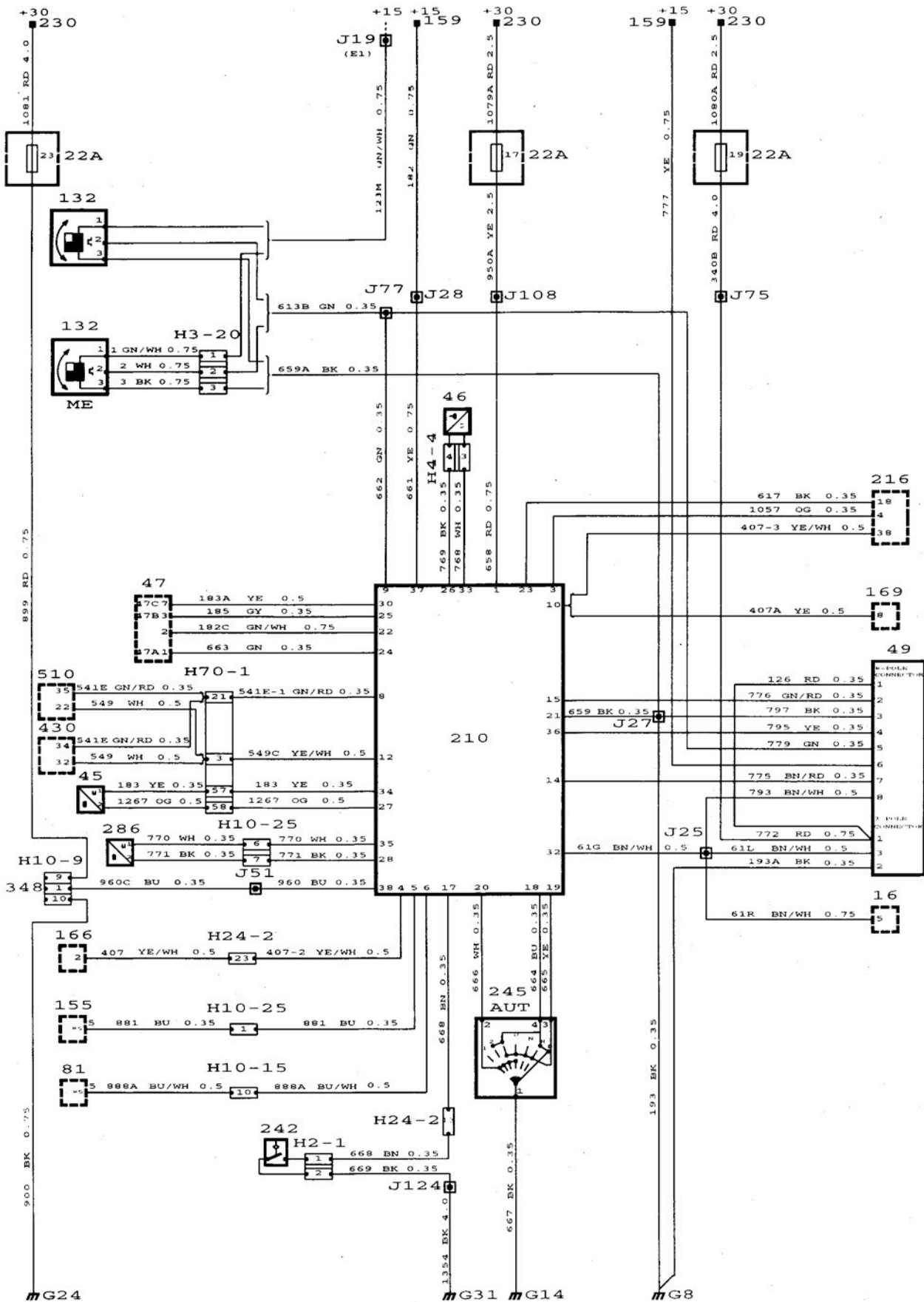

Description of operation

General

The EDU 3 trip computer (Electronic Display Unit) is available in two basic versions, one for a manual gearbox and one for automatic transmission. The computer is programmable, which means that a replacement trip computer must be programmed for the car model, etc. in which it is fitted.

Programming is performed with the ISAT scan tool. In addition, the ISAT scan tool can be used to carry out certain adjustments and tests and to obtain read-outs of diagnostic trouble codes.

The trip computer provides the following information:

In the left-hand part of the display

- Current and average fuel consumption.
- Range on remaining fuel.
- Battery voltage.
- Outside temperature.

In the right-hand part of the display

- Selector lever position (on cars with automatic transmission).
- Current fuel consumption (horizontal scale).
- Warning message CHECK ENGINE (malfunction indicator lamp) in the event of a malfunction in the Trionic or Motronic engine management systems or in the ETS electronically controlled throttle.
- Warning message CHECK RADIATOR LEVEL if the coolant level is too low.

When the ignition is switched on, all check indicator lamps should light up and then go out one by one within 4 seconds.

Use the R and INFO buttons to select the different functions of the trip computer and the display in km or miles, for instance. The buttons are situated on clock 49 or SCC trip computer 241.

- Trip computer 210 is supplied with current continuously via fuse 17 and also via fuse 13 when the ignition switch is in the Drive position.
- The brightness of the display is automatically adjusted in daylight by means of a sensor on either the SCC unit or the clock. When driving in the dark, display brightness can be adjusted with rheostat 16 (lighting for controls).

Cars with a manual gearbox



Cars with automatic transmission



Fuel consumption

In order to calculate and present current and average fuel consumption, the trip computer requires data on:

- the distance driven from vehicle speed sensor 132 via pin 9.
- current fuel consumption from the engine control module via pin 8. The control module uses the control pulses to the injectors, the frequency of which corresponds to the current fuel consumption.

Range on remaining fuel.

To show the range (the distance that can be driven with the fuel remaining in the tank), fuel level sensor 46 is connected to the trip computer via pin 33. The trip computer calculates the range from the average fuel consumption over the last 20 minutes.

Quantity of fuel

The trip computer supplies about 12 V to the fuel gauge via pin 22. From pin 24 the trip computer supplies a 1-9 V signal which controls the reading shown on fuel gauge 47A.

1 V = tank empty, 9 V = tank full. When about 10 litres of fuel remains in the tank the trip computer grounds, via pin 25, the indicator lamp (low fuel warning 47B), which then lights up.

Engine coolant temperature

The trip computer supplies about 12 V to the coolant temperature gauge via pin 22. From pin 24 the trip computer supplies a 1-9 V signal which controls the reading shown on coolant temperature gauge 47C.

1 V = minimum temperature, 9 V = maximum temperature.

Outside temperature

Information about the current outside temperature is obtained from outside temperature sensor 286 via pin 35. The sensor is located behind the car's front spoiler.

After processing, the current outside temperature value is sent to the ACC control module via pin 23. The signal is a pulse train.

The ice warning function is automatically activated and displays the outside temperature as soon as the temperature comes within the range of -3 °C to +3 °C. The temperature is then shown on the display until another function is selected with the INFO button or until the outside temperature leaves the range -6 °C to +6 °C, that is to say the function has a certain hysteresis (delay).

Low coolant level

The warning signal for low coolant level is received from sensor 242 via pin 17. The sensor closes when the level is too low.

Radiator fan control

The radiator fans are controlled via the trip computer. By grounding relay 155 via pin 5, the fan starts at low speed (2-speed fan 366) or in the case of fan 37, at normal speed. Relay 81 is grounded via pin 6, which activates the high speed mode on the 2-speed fan.

After-running of the fans is also controlled by the trip computer. When the ignition switch is turned to the OFF position, the trip computer checks the temperature of the coolant. If it is too high, the trip computer allows after-running for a maximum of 3.5 minutes.

A/C control

When the A/C system is to be engaged, a 12 V signal is received via pin 10 from ACC control module 216 or from A/C switch 169. The trip computer checks the temperature of the coolant and if it is not too high, sends a 12 V signal via pin 4 to pressure switch 166.

CHECK ENGINE

The malfunction indicator (CHECK ENGINE) lamp in the trip computer lights up if there is a fault in the Trionic or Motronic systems. The data is received via pin 12.

Gear position indication

In cars with automatic transmission, the trip computer is connected to transmission range switch 245 via pins 18, 19 and 20.

Signals from the clock/SCC

The following information comes from the clock or the SCC:

- INFO button via pin 14.
- R button via pin 15.
- Light sensor signal via pin 36.

Backlighting

Lighting of the display is controlled by rheostat 16 and also by the value of the light sensor.

The operation of the trip computer is described in more detail in Service Manual "3:5 Electrical system, EDU".

Fault diagnosis hints

Check fuses 13 and 17.

Check the relevant wiring harness connections, connectors and grounding points.

Resistances for outside temperature sensor

	Minimum kohms	Maximum kohms
± 0°C	5.8	6.2
+ 10°C	3.8	4.1
+ 20°C	2.5	2.8
+ 30°C	1.7	1.9

Resistances for engine coolant temperature sensor

	Minimum kohms
± 0°C	5.7
+ 10°C	3.7
+ 20°C	2.4
+ 30°C	1.6
+ 60 °C	0,57
+ 80 °C	0.3
+100 °C	0,18
+110 °C	0,14
+120 °C	0,11

All diagnostic and trouble code readouts obtained by means of the ISAT scan tool are described in Service Manual "3:5 EDU programmable trip computer".

Component locations

16	Rheostat, lighting for controls, on dashboard between the steering wheel and driver's door.	H2-1	<i>2-pin connector</i> Beside the coolant expansion tank.
22A	Fuse board behind the cover flap in the glove box.	H3-20	<i>3-pin connector</i> Behind the main instrument display panel beside the speedometer (ME).
45	Engine coolant temperature sensor on left-hand side of thermostat housing.		<i>4-pin connector</i>
46	Fuel level sensor in fuel tank under the luggage compartment floor.	H4-4	Beside the fuel pump under the luggage compartment floor.
	<i>in the main instrument display panel</i>		<i>10-pin connectors</i>
47A	Fuel gauge	H10-15	Behind the left-hand headlamp.
47B	Fuel level indicator lamp.	H10-25	Behind the left-hand headlamp.
47C	Coolant temperature gauge		<i>24-pin connector</i>
49	Clock in the centre of the dashboard.	H24-2	Behind the left-hand headlamp.
			<i>70-pin connector</i>
81	Relay, 2-speed radiator fan, in main fuse box in front of the battery.	H70-1	In the engine bay, behind the bulkhead partition.
132	Vehicle speed sensor, in the speedometer.	G8	Grounding point, dashboard, by the left-hand front loudspeaker socket.
155	Relay, A/C radiator fan, in main fuse box in front of the battery.	G14	Grounding point, left-hand seat member, under the left-hand front seat.
159	Distribution terminal (+15 circuit) in main fuse box behind the glove box.	G24	Grounding point, right-hand seat member, under the right-hand front seat.
166	3-stage pressure switch for radiator fan, on the receiver in front of the right-hand wheel housing.	G31	Grounding point, right-hand structural member behind the right-hand headlamp.
169	A/C switch, on the dashboard between the centre panel and steering wheel.		
210	EDU trip computer in the main instrument display panel.		
216	ACC control module in the middle of the dashboard.		
230	Distribution terminal (+30 circuit) in main fuse box behind the glove box.		
242	Coolant level switch in the coolant expansion tank.		
245	EDU transmission range switch (automatic transmission) beside the selector lever.		
286	Outside temperature sensor, on the left-hand side behind the front spoiler.		
348 (H10-9)	Scan tool diagnostics data link connector under the right-hand seat.		
430	Control module, Trionic engine management system, in engine bay on left-hand side behind the bulkhead partition.		
510	Motronic control module, in engine bay behind the bulkhead partition.		

Components

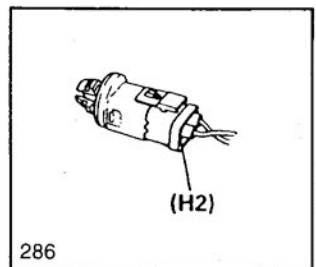
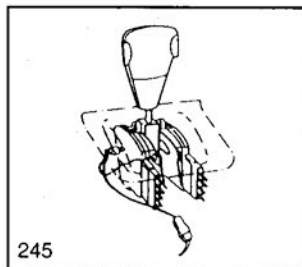
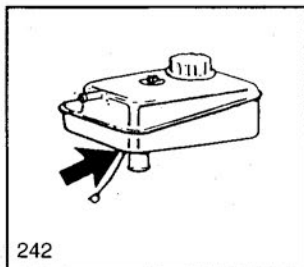
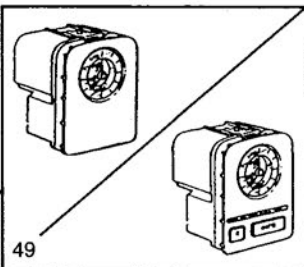
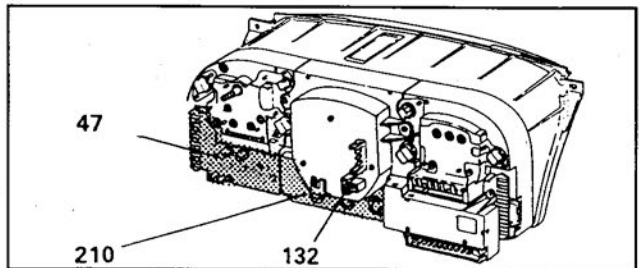
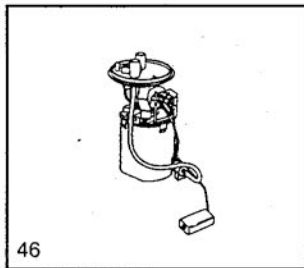
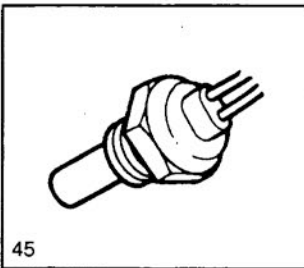
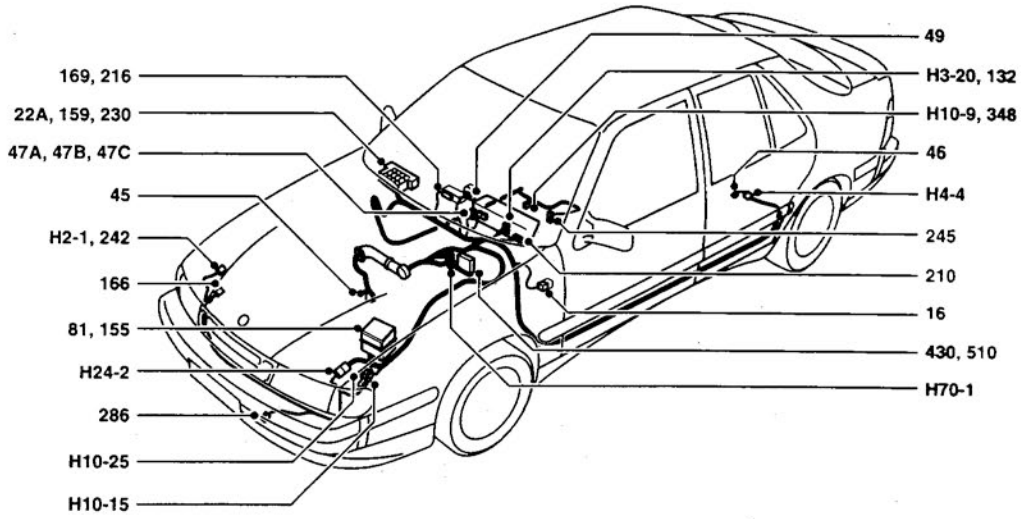

SCC trip computer

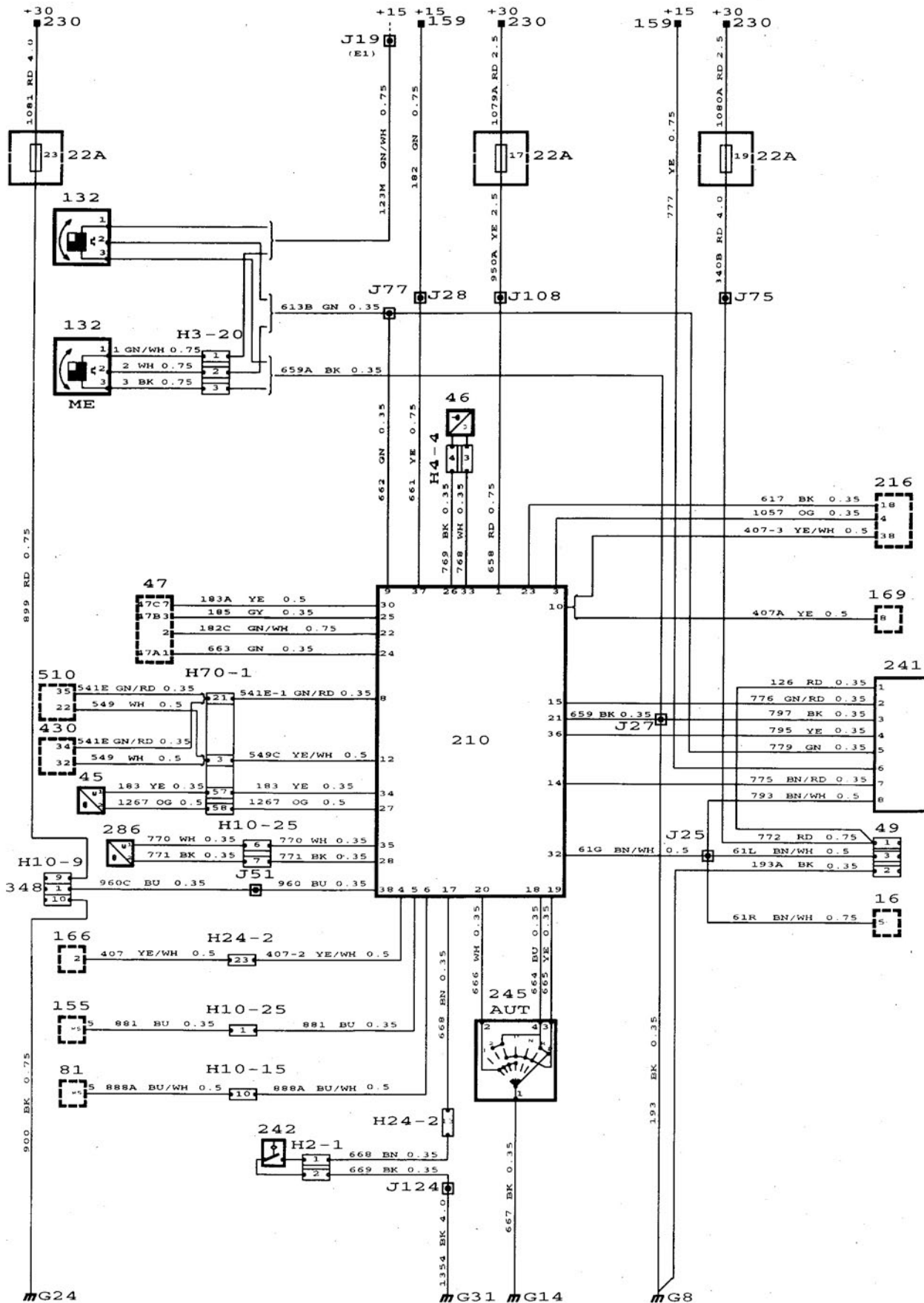

Description of operation

The SCC trip computer (Saab Car Computer) has the following functions:

(left-hand side ◀)

- DIST. TO DEST. (distance to destination).
- AVER. SPEED (average speed).
- SPEED WARN. (speed warning)

(right-hand side ▶)

- CLOCK (clock function).
- ARRIVAL (arrival time).
- ALARM (alarm function).



The trip computer is operated by means of the buttons situated below the display.

Presentation in kilometres or miles can also be selected with these buttons.

For a further description of operation and directions for use, see the car's "Owner's Manual".



The bottom row on the trip computer includes a light sensor and two buttons. The light sensor is used for automatic control of display brightness on the SCC and EDU trip computer in daylight.

The brightness of the button illumination is controlled by rheostat 16 (lighting for controls) on the dashboard.

R and **INFO** are used for the EDU trip computer. These, together with the light sensor, are connected to trip computer EDU 210 via an 8-pin connector. For more information on the EDU trip computer, see Service Manual "3:5 Electrical system, EDU".

SCC trip computer 241 is supplied with current from fuse 19 continuously and also from fuse 13 when the ignition switch is in the Drive position.

To process and display the information for the different functions, the trip computer requires information from vehicle speed sensor 132, terminal 2. The signal is obtained via the EDU.

Fault diagnosis hints

The trip computer is activated by turning the ignition switch to the Drive position.

- 1 Check that fuses 13 and 19 are OK and supplied with current.
- 2 Check that current is supplied to pin 1 of the trip computer, via clock 49 and pin 6.
- 3 Check that current is supplied to vehicle speed sensor 132, terminal 1, and from the vehicle speed sensor, terminal 2, to the EDU trip computer, terminal 9.
- 4 Check that current is supplied from the EDU to the SCC.
- 5 Check that the contact surfaces of the connectors are undamaged and clean. This is important as the currents involved are weak.
- 6 Check the wiring harness and ground connections.

All diagnostic and trouble code readouts obtained by means of the ISAT scan tool are described in Service Manual "3:5 EDU programmable trip computer".

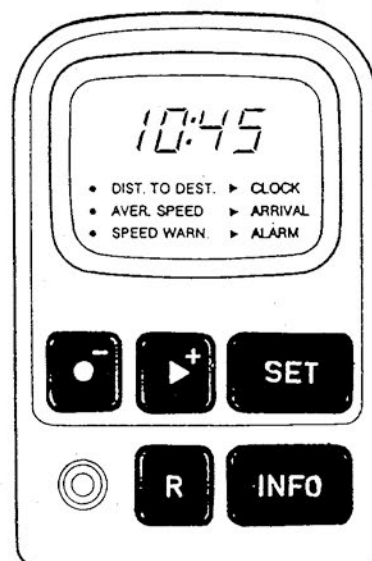

Component locations

16	Rheostat, lighting for controls, on dashboard between the steering wheel and driver's door.	H2-1	<i>2-pin connector</i> Beside the coolant expansion tank.
22A	Fuse board behind the cover flap in the glove box.	H3-20	<i>3-pin connector</i> Behind the main instrument display panel beside the speedometer (ME).
45	Engine coolant temperature sensor, on the left-hand side of the thermostat housing.		<i>4-pin connector</i>
46	Fuel level sensor in fuel tank under the luggage compartment floor. <i>in the main instrument display panel</i>	H4-4	Beside the fuel pump under the luggage compartment floor. <i>10-pin connectors</i>
47A	Fuel gauge	H10-15	Behind the left-hand headlamp.
47B	Fuel level indicator lamp.	H10-25	Behind the left-hand headlamp.
47C	Coolant temperature gauge		<i>24-pin connector</i>
81	Relay, 2-speed radiator fan, in main fuse box in front of the battery.	H24-2	Behind the left-hand headlamp. <i>70-pin connector</i>
132	Vehicle speed sensor, in the speedometer.	H70-1	In the engine bay, behind the bulkhead partition.
155	Relay, A/C radiator fan, in main fuse box in front of the battery.	G8	Grounding point, dashboard, by the left-hand front loudspeaker socket.
159	Distribution terminal (+15 circuit) in main fuse box behind the glove box.	G14	Grounding point, left-hand seat member, under the left-hand front seat.
166	3-stage pressure switch for the radiator fan, on the receiver in front of the right-hand wheel housing.	G24	Grounding point, right-hand seat member, under the right-hand front seat.
169	A/C switch, on the dashboard between the centre console and steering wheel.	G31	Grounding point, right-hand structural member behind the right-hand headlamp.
210	EDU trip computer in the main instrument display panel.		
216	ACC control module in the middle of the dashboard.		
230	Distribution terminal (+30 circuit) in main fuse box behind the glove box.		
241	SCC trip computer in the centre of the dashboard.		
242	Coolant level switch in the coolant expansion tank.		
245	EDU transmission range switch (automatic transmission) beside the selector lever.		
286	Outside temperature sensor, on left-hand side behind the front spoiler.		
348 (H10-9)	Scan tool diagnostics data link connector under the right-hand seat.		
430	Control module, Trionic engine management system, in engine bay on the left-hand side behind the bulkhead partition.		
510	Motronic control module, in engine bay behind the bulkhead partition.		

Components

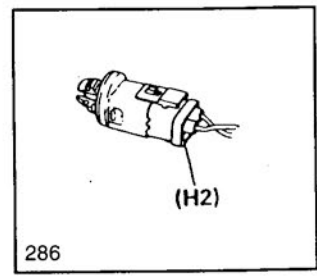
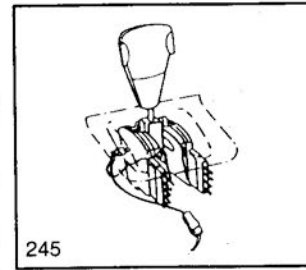
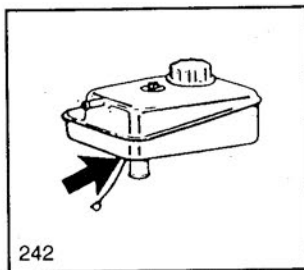
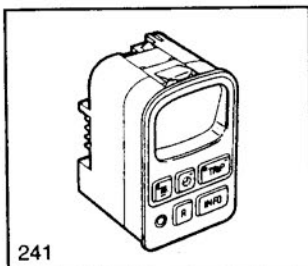
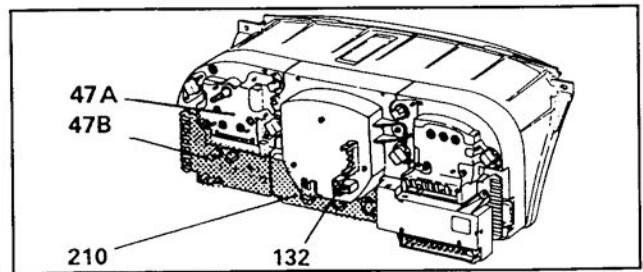
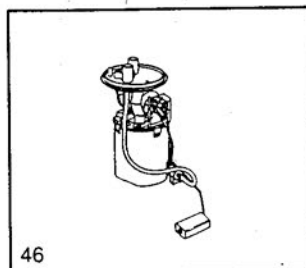
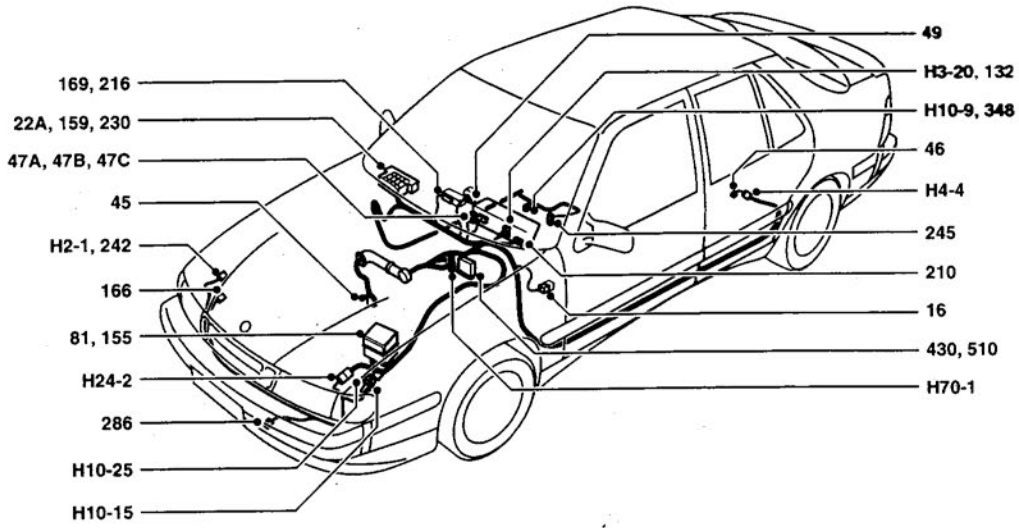

C381W-4540

Description of operation

47E Indicator lamp, charging

The charging indicator lamp indicates to the driver whether the battery is being charged or not.

When ignition switch 20 is in the Drive position, current (+15 circuit) is supplied via fuse 13 to pin 5 of the main instrument display panel and on to one of the poles of indicator lamp 47E. The other lamp pole is connected to generator 2 via pin 3 in the main instrument display panel.

When the generator is not rotating or if it is not charging for some reason or other, the charging warning lamp circuit is grounded through the generator and the lamp will light up.

When the generator is charging, terminal D+ receives the same voltage as B+. The charging lamp is then supplied with the same voltage on both terminals and the lamp goes out.

For a complete description and fault-tracing hints, see the section **Starting and charging systems**, on page 51.

47F Brake warning lamp

The brake warning lamp indicates to the driver when the level is too low in the brake fluid reservoir.

When the ignition switch is in the Drive position, current (+15 circuit) is supplied via fuse 13 and pin 5 of the main instrument display panel to one of the poles of warning lamp 47. The other pole of the lamp is connected via pin 11 of the main instrument display panel to brake warning lamp switch 42. If the level of brake fluid in the reservoir is too low, the switch closes and the warning lamp lights up.

For cars equipped with ABS, see the **ABS anti-lock brakes** section on page 353.

Fault diagnosis hints

The brake warning lamp is activated by turning the ignition switch to the Drive position.

- 1 Check the brake system warning circuit by pressing the button located on the brake fluid reservoir. The float is then grounded and the lamp should light up.
- 2 Check that fuse 13 is intact and supplied with current.
- 3 Check that the bulb is OK and that the lamp connections on the card for warning and indicator lamps are supplied with current.
- 4 Check the connectors, wiring harness and ground connections.

47G Indicator lamp, full beam

The indicator lamp shows the driver when full beams are on.

One pole of the indicator lamp is supplied with current from full beam fuse 3 via pin 2 of the main instrument display panel. The other pole of the indicator lamp is grounded via pin 7 of the main instrument display panel.

For a complete description and fault-tracing hints, see the section entitled **Headlamps**, on page 105.

47J Indicator lamp, electrically heated rear window

The indicator lamp shows the driver when the electrically heated rear window is switched on. When it is, one pole of the indicator lamp is supplied with current via pin 10 of the main instrument display panel. The other pole of the lamp is grounded via pin 7 of the main instrument display panel.

For a complete description and fault-tracing hints, see the section entitled **Electrically heated rear window**, on page 285.

47K Indicator lamp, upshift (US, manual gearbox)

The indicator lamp indicates to the driver that a higher gear should be engaged.

One pole of the indicator lamp is supplied with current via pin 5 of the main instrument display panel. The other pole of the lamp is grounded via pin 14 from pin 55 of Trionic control module 430.

47L EXH Indicator lamp

In certain markets, an EXH indicator lamp is included which reminds the driver that parts of the exhaust emission control system must be maintained.

One pole of the pilot lamp is supplied with current from pin 5 of the EXH relay via pin 14 of the lamp unit. The other pole of the lamp is grounded via pin 7 of the lamp unit.

For a complete description and fault-tracing hints, see the section entitled **EXH Warning**, on page 261.

47M Indicator lamp, handbrake

The handbrake indicator lamp shows the driver when the handbrake is applied.

When ignition switch 20 is in the Drive position, current (+15 circuit) is supplied via fuse 13 to pin 5 of the main instrument display panel and to one pole of indicator lamp 47M. The other pole of the lamp is connected to handbrake switch 43 via pin 13 of the main instrument display panel. The lamp remains on as long as the handbrake is applied.

Fault diagnosis hints

The indicator lamp is activated when the ignition switch is turned to the Drive position.

- 1 Check that fuse 13 is intact and supplied with current.
- 2 Check that the bulb is OK and that the lamp connections on the card for warning and indicator lamps are supplied with current.
- 3 Disconnect the cable and ground it to the handbrake switch. If the lamp lights up, the circuit is OK.
- 4 Check the connectors, wiring harness and ground connections.

47N Indicator lamp, rear fog light

In certain markets, an indicator lamp is included which shows the driver when the rear fog light is switched on. One pole of the indicator lamp is supplied with current via pin 6 of the main instrument display panel. The other pole of the lamp is grounded via pin 7 of the main instrument display panel.

For a complete description and fault-tracing hints, see the section entitled **Rear fog light** on page 151.

47Q ABS Indicator lamp

If there is a fault in the ABS or TCS systems, warning lamp 47Q lights up and the system is disconnected. The car's brake system then works as a conventional system.

One pole of the lamp is supplied with current via pin 5 and grounded via pin 8 in each system.

47R Indicator lamp, washer fluid level

The washer fluid level indicator lamp shows the driver when the washer fluid is about to run out.

When ignition switch 20 is in the Drive position, current (+15 circuit) is supplied via fuse 13 to pin 5 of the main instrument display panel and on to one pole of indicator lamp 47R.

The other pole of the lamp is connected to level switch 195 via pin 9 of the main instrument display panel. When the level in the reservoir has dropped to 0.5 litres or less, the level switch closes and the lamp lights up.

Fault diagnosis hints

The level sensor is activated by the ignition switch being turned to the Drive position.

- 1 Check that fuse 13 is intact and supplied with current.
- 2 Check that the bulb is OK and that the lamp connections on the card for warning and indicator lamps are supplied with current.
- 3 With 0.5 dm (litres) in the reservoir, the sensor should close and the lamp light up.
- 4 Check the connectors, wiring harness and ground connections.

47U Indicator lamp, Cruise Control

In certain markets, an indicator lamp is included which shows the driver when the Cruise Control is on. One pole of the indicator lamp is supplied with current via pin 6 of the main instrument display panel. The other pole of the lamp is grounded via pin 7 of the main instrument display panel. For a complete description and fault-tracing hints, see the section entitled **Cruise control system**, on page 325.

47Y TCS OFF indicator lamp

Cars equipped with the TCS have a switch for manually disengaging the system. When the system is manually disengaged, indicator lamp 47Y lights up.

One pole of the indicator lamp is supplied with current via pin 5. The other pole is grounded via pin 12 of the TCS control module that the car is equipped with.

Testing the indicator and warning lamps

By turning ignition switch 20 to a special Test position it is possible to check whether certain lamps on card 47 (for indicator and warning lamps) are OK. The Test position is situated between the Drive and Start positions.

When the ignition switch is turned to the Drive position, current (+15 circuit) is supplied via fuse 13 to the lamps that are to be tested (terminal 5 on card 47 for pilot and warning lamps).

When the ignition switch is then turned to the Test position, positive current continues to be supplied at the same time as the lamps are grounded via pin 1 of the main instrument display panel and because terminals C and C1 of the ignition switch are connected to each other.

The following lamps are connected in circuit during the test:

- 47F Warning lamp, brakes
- 47M Indicator lamp, handbrake
- 47R Indicator lamp, washer fluid level

Component locations

2	Generator at the rear of the engine on the right-hand side.	342A	Fuse board in main fuse box in front of battery.
20	Ignition switch, on the right-hand side of the steering column.	376	ETS throttle control module, under left-hand front seat.
42	Brake fluid level warning switch, on the brake fluid reservoir behind the battery.	382	TC-ABS control module, on the battery tray.
43	Handbrake switch, under the handbrake lever.	416	Relay, EXH warning, on a bracket behind the front seat member on the right-hand side.
47	Main instrument display panel <i>in the main instrument display panel</i>	430	Control module, Trionic engine management system, in engine bay on the left-hand side behind the bulkhead partition.
47E	Charging indicator lamp.		
47F	Warning lamp, brakes.	507	TCS V6 control module, under the left-hand front seat.
47G	Full beam indicator lamp		
47J	Indicator lamp, electrically heated rear window.	508	Control module, Cruise Control system, adjacent to the battery tray.
47K	SHIFT UP indicator light.		
47L	EXH warning lamp.		<i>2-pin connectors</i>
47M	Indicator lamp, handbrake.	H2-10	Beside the washer fluid reservoir.
47N	Indicator lamp, rear fog light.	H2-19	Under the dashboard to the left of the steering wheel.
47Q	ABS/ ABS-TCS warning lamp.		<i>4-pin connector</i>
47R	Indicator lamp, washer fluid level.		
47U	Cruise Control system indicator lamp.	H4-15	To the left under the right-hand seat.
47Y	TCS CTRL warning lamp		<i>6-pin connector</i>
113	Time-delay relay, electrically heated rear window, in main fuse box behind the glove box.	H6-5	In the front right-hand corner behind the light cluster beside the washer fluid reservoir.
113	Relay, electrically heated rear window, in main fuse box behind the glove box.		<i>10-pin connector</i>
141	Cruise Control switch on the direction indicator stalk switch on the left-hand side of the steering wheel.	H10-15	Behind the left-hand headlamp.
			<i>24-pin connectors</i>
		H24-1	In the engine bay on the bulkhead partition.
159	Distribution terminal (+15 circuit) in main fuse box behind the glove box.	H24-2	Behind the left-hand headlamp.
			<i>70-pin connector</i>
161	Rear fog light switch, on the dashboard between the steering wheel and driver's door.	H70-1	In the engine bay, behind the bulkhead partition.
		G2	Grounding point, battery tray, on the left-hand wheel housing.
195	Level switch, in the washer fluid reservoir in the right-hand wheel housing.	G8	Grounding point, dashboard, by the left-hand front loudspeaker socket.
		G31	Grounding point, right-hand structural member behind the right-hand headlamp.
213	Pictogram, in the main instrument display panel.		
228B	Filament monitor, front lamps, in main fuse box in front of the battery.		
291	ABS control module on the battery tray.		
294	TC-ABS pressure switch, on the hydraulic unit.		
299	Brake fluid level sensor, TC-ABS, in the brake fluid reservoir.		

Components

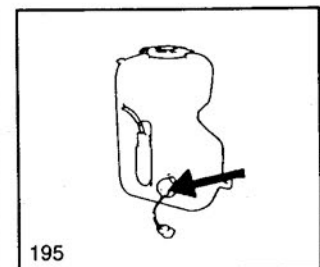
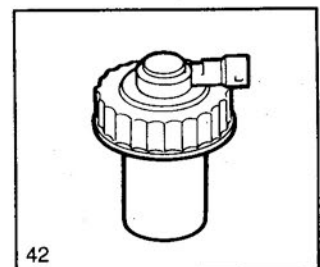
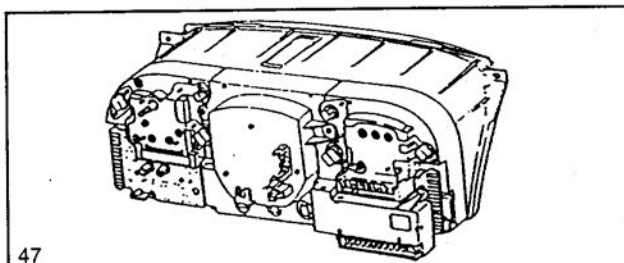
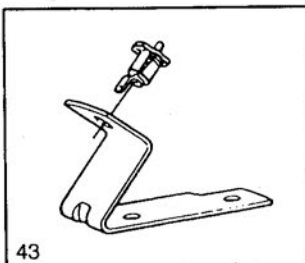
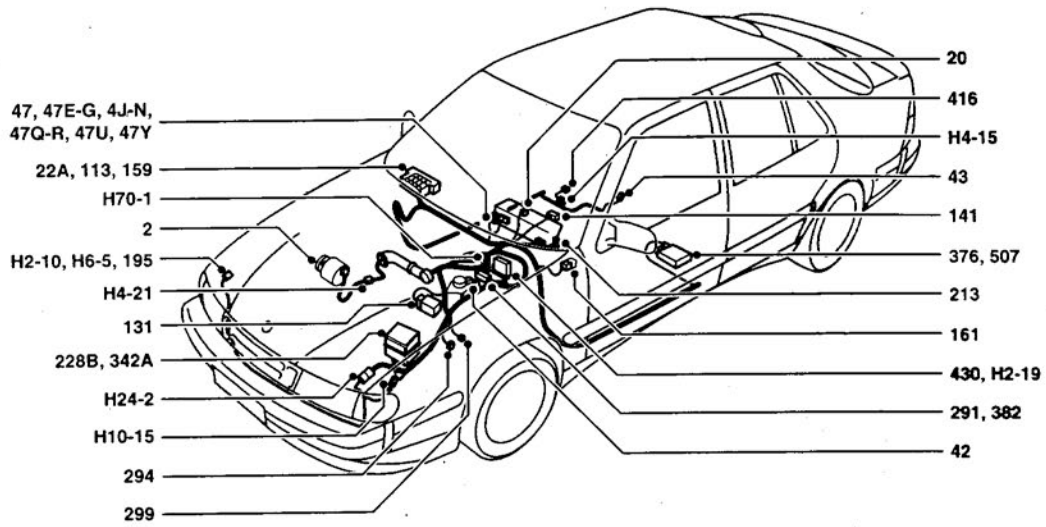

C381W-4541

Pictogram-Filament monitor without memory

(SOP) This wiring diagram has been superseded during the model year by the schematic on page 240.

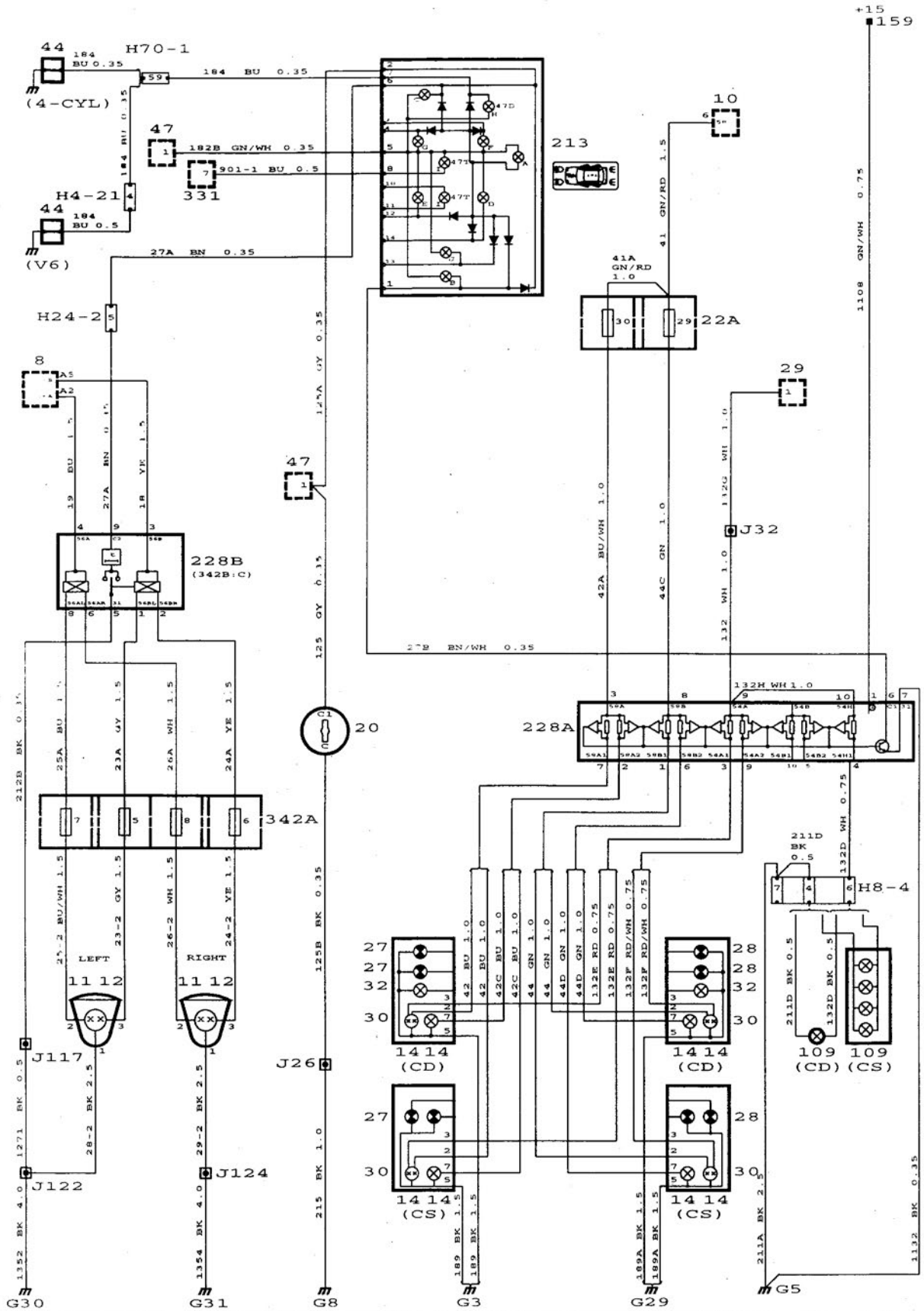

Pictogram-Filament monitor (with memory), oil pressure warning lamp

(SOP) This wiring diagram has been superseded during the model year by the schematic on the next page.

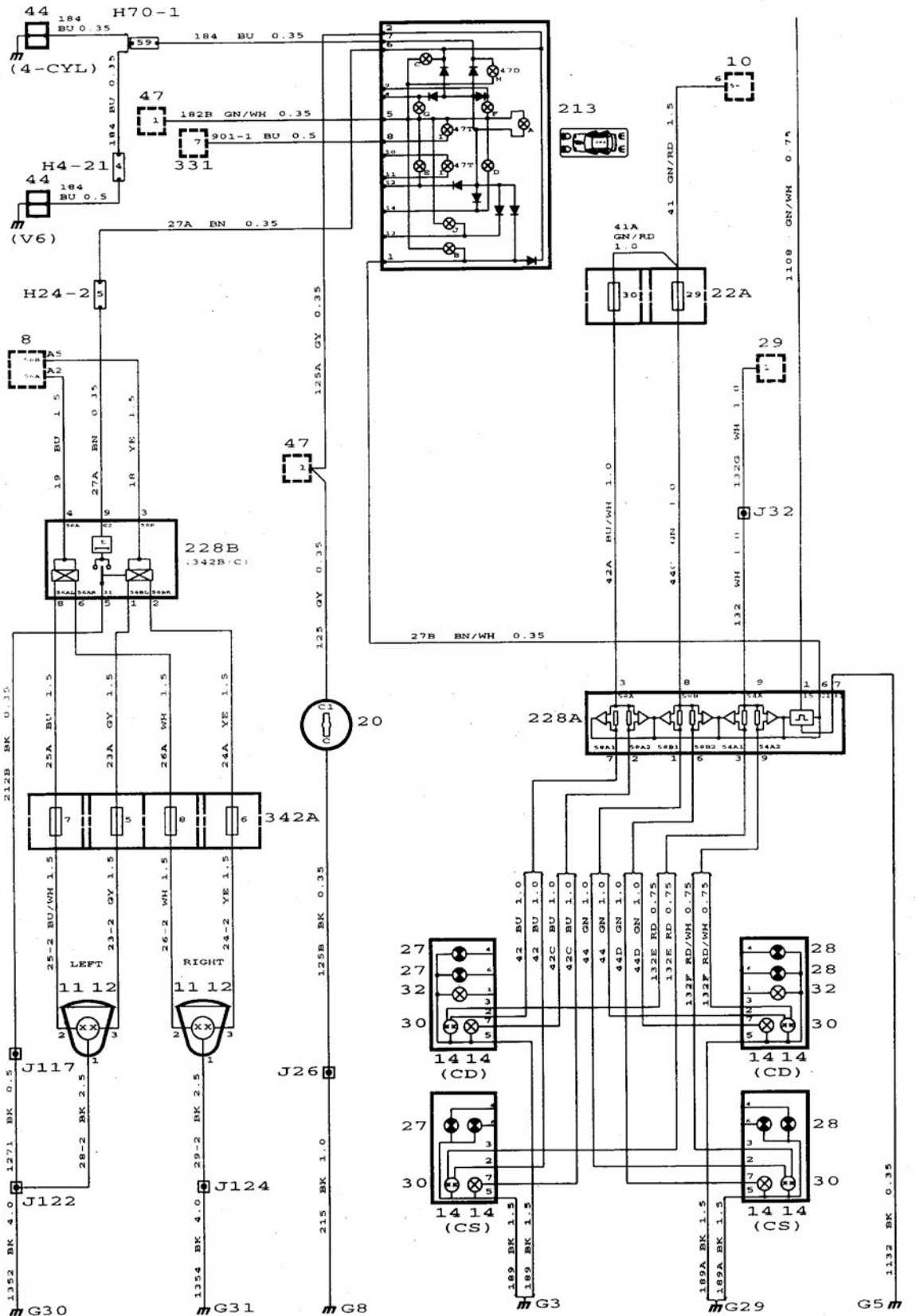

Pictogram-Filament monitor (with memory), oil pressure warning lamp

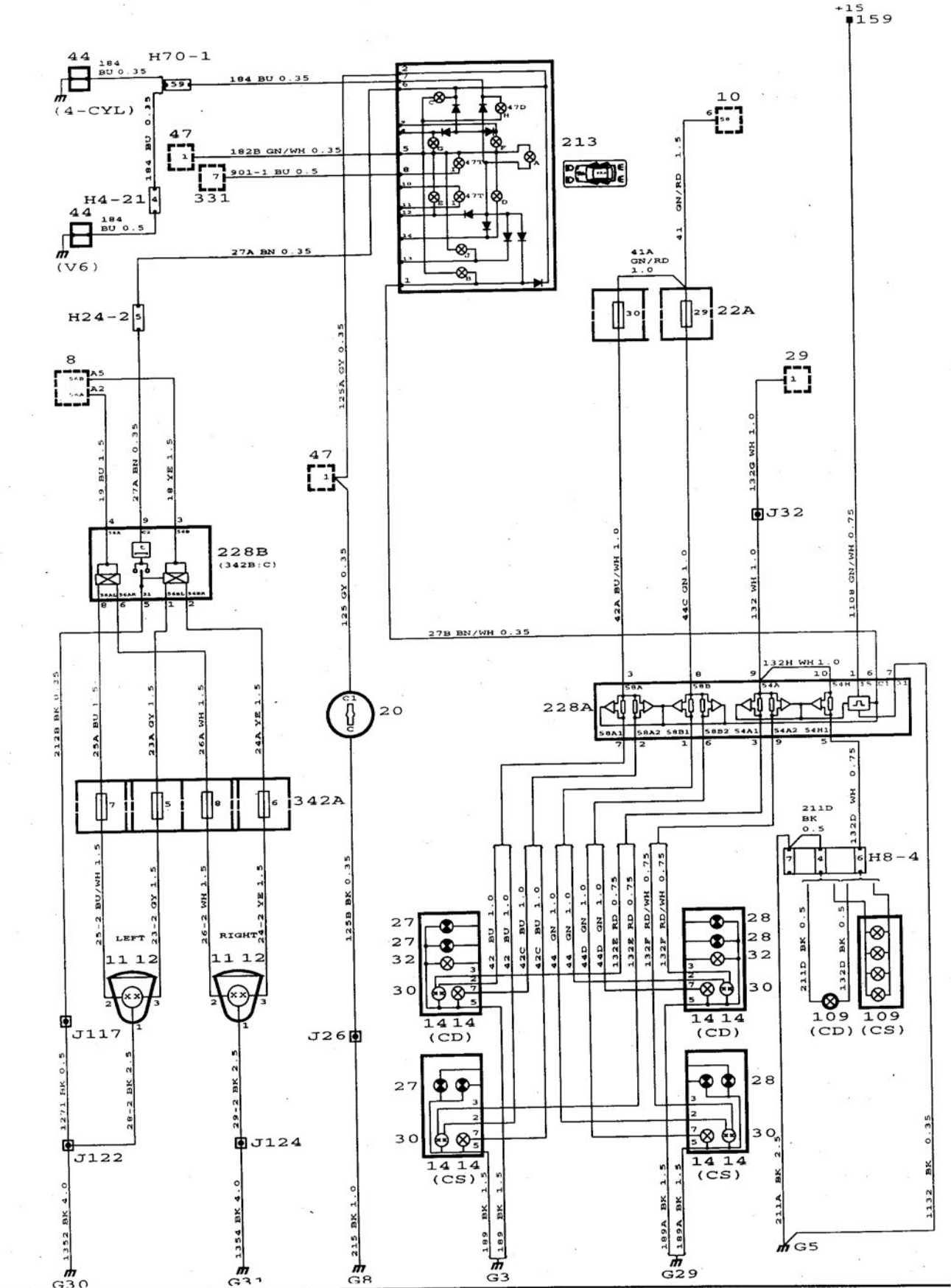

Description of operation

Certain parts of the car's lighting system are monitored by two filament monitors 228A and B and pictogram 213.

The five lamps F, G, D, E and J in the pictogram are covered individually in the **Pictogram-Door indication** section on page 247.

Filament monitor

Filament monitor 228B monitors full and dipped beams and filament monitor 228A monitors rear lights and brake lights.

Filament monitor 228B incorporates relays which act on the pictogram and light lamp C if there is a fault while filament monitor 228A incorporates shunt resistors which act on the pictogram and light lamp B if there is a fault.

The lamp in the centre, A (central warning lamp), lights up the car's outline on the pictogram and always comes on when a fault is detected.

When ignition switch 20 is in the Drive position, current is supplied to pictogram terminal 5.

Front filament monitor

If there is a fault in any lighting circuit, an imbalance arises and the relay is activated. Terminal C2 in the filament monitor and lamps C and A (central warning lamp) in the pictogram are grounded and the lamps light up.

Rear filament monitor

The filament monitor senses if the current to one of the lamps is incorrect. Terminal C1 in the filament monitor and lamps B and A (central warning lamp) in the pictogram are grounded and the lamps light up.

In certain markets, the filament monitor incorporates a circuit for monitoring brake light switch 29, see the section entitled **Brake lights with/without reset memory**, on page 133.

For high-level brake lights, there is a special monitoring function for brake light 109. see the section entitled **Brake lights and high-level brake light**, on page 139.

Oil pressure warning lamp 47D

The oil pressure warning lamp shows the driver if the engine oil pressure becomes too low.

If the engine oil pressure drops below 0.3-0.5 bar, the engine oil pressure sensor closes and lamp 47D lights up.

The pictogram central warning lamp is also grounded and the pictogram lights up.

Airbag warning lamp 47T

The airbag warning lamp shows the driver if there is a fault in the airbag system, see the section entitled **Airbag**, on page 367.

Testing the indicator and warning lamps

When the ignition switch is turned to the Drive position, current is supplied to those lamps that are to be tested (terminal 5 on the pictogram).

When the ignition switch is then turned to the Test position, which is situated between the Drive and Start positions, positive current continues to be supplied at the same time as the lamps are grounded as connections C and C1 of the ignition switch are connected to each other.

The following lamps in the pictogram are connected in circuit during testing:

- Central warning lamp A
- Lamp C for front lighting
- Lamp B for rear lighting
- Oil pressure warning lamp H/ 47D

Fault diagnosis hints

The indicator lamps in pictogram 213 are activated by turning ignition switch 20 to the Drive position.

- 1 Check that current is supplied to terminal 5 of the pictogram.
- 2 Check the pictogram bulbs. Do this with the ignition switch in the Test position, see above.
- 3 Check that terminal 1 of filament monitor 228A is supplied with current in the Drive position (certain markets only).
- 4 With the ignition in the Drive position, disconnect and ground the engine oil pressure sensor cable. If the lamp lights up, the circuit is OK.
- 5 Check the connectors, wiring harness and ground connections.

When changing the filament monitor, check against the spare parts catalogue that it is replaced with the correct variant for the market in question.

Component locations

8	Lighting relay, in main fuse box in front of the battery.	H4-21	4-pin connector Beside the generator (V6).
10	Lights switch on dashboard between steering wheel and driver's door.	H8-4	8-pin connector By the left-hand rear wheel housing.
11	Full beam in LH and RH headlamps.		24-pin connector
12	Dipped beam in LH and RH headlamps.	H24-2	Behind the left-hand headlamp. 70-pin connector
14	Rear lights in the rear light clusters.	H70-1	In the engine bay, behind the bulkhead partition.
20	Ignition switch, on the right-hand side of the steering column.	G3	Grounding point, luggage compartment, beside the rear left-hand light cluster.
27	Direction indicator lamps, left-hand side, in front and rear light clusters.	G5	Grounding point, under the rear seat on the left.
28	Direction indicator lamps, right-hand side, in front and rear light clusters.	G8	Grounding point, dashboard, by the left-hand front loudspeaker socket.
29	Brake light switch beside the brake pedal.	G29	Luggage compartment grounding point, right-hand, beside the rear right-hand light cluster.
30	Brake lights in each rear light cluster.	G30	Grounding point on the left-hand structural member behind the left-hand headlamp.
32	Reversing light bulbs: CD: in rear light clusters. CS: in tailgate light fitting.	G31	Grounding point, on the right-hand structural member behind the right-hand headlamp.
44	Engine oil pressure sensor: 2.0 I, T: on the upper part of the oil housing to the right at the rear of the engine. 2.3 I, T: on the block at the front of the engine.		
47	Main instrument display panel in the dashboard.		
109	High-level brake light CD: in rear window. CS: in tailgate.		
159	Distribution terminal (+15 circuit) in main fuse box behind the glove box.		
213	Pictogram, in the main instrument display panel.		
228A	Filament monitor, rear lamps, in luggage compartment on the left-hand side.		
228B	Filament monitor, front lamps, in main fuse box in front of the battery.		
331	SRS control module, in front part of the centre console under the dashboard.		
342A	Fuse board in main fuse box in front of battery.		

Components

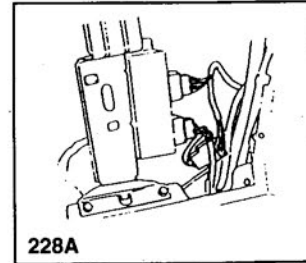
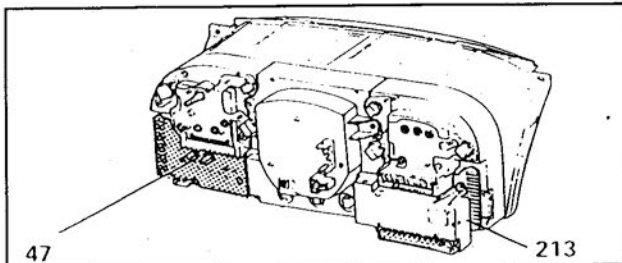
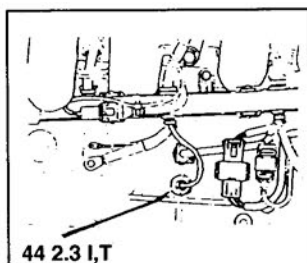
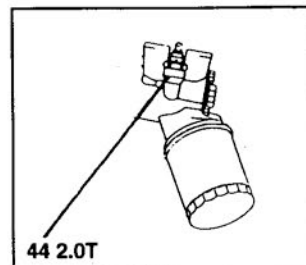
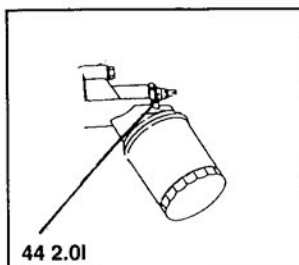
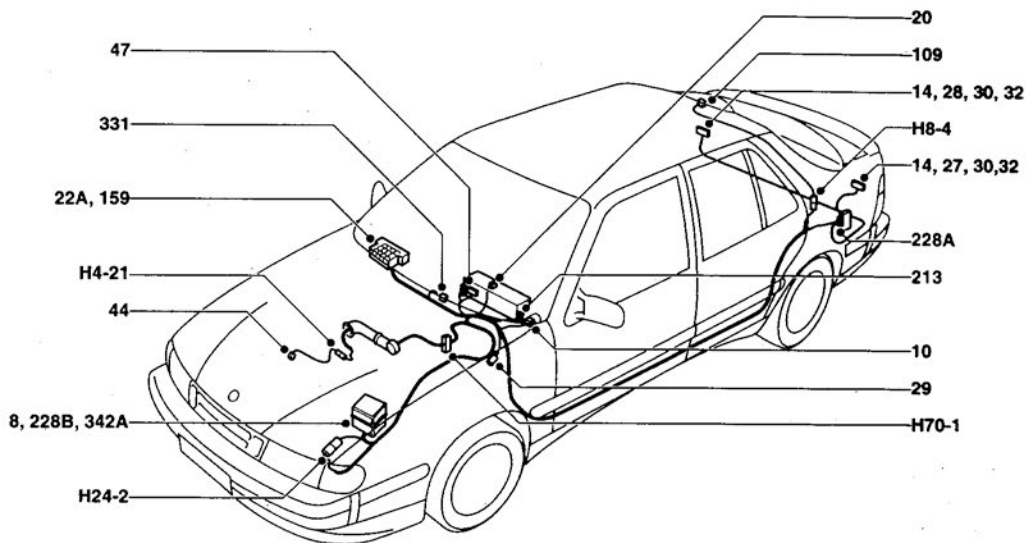

Pictogram - Door indication

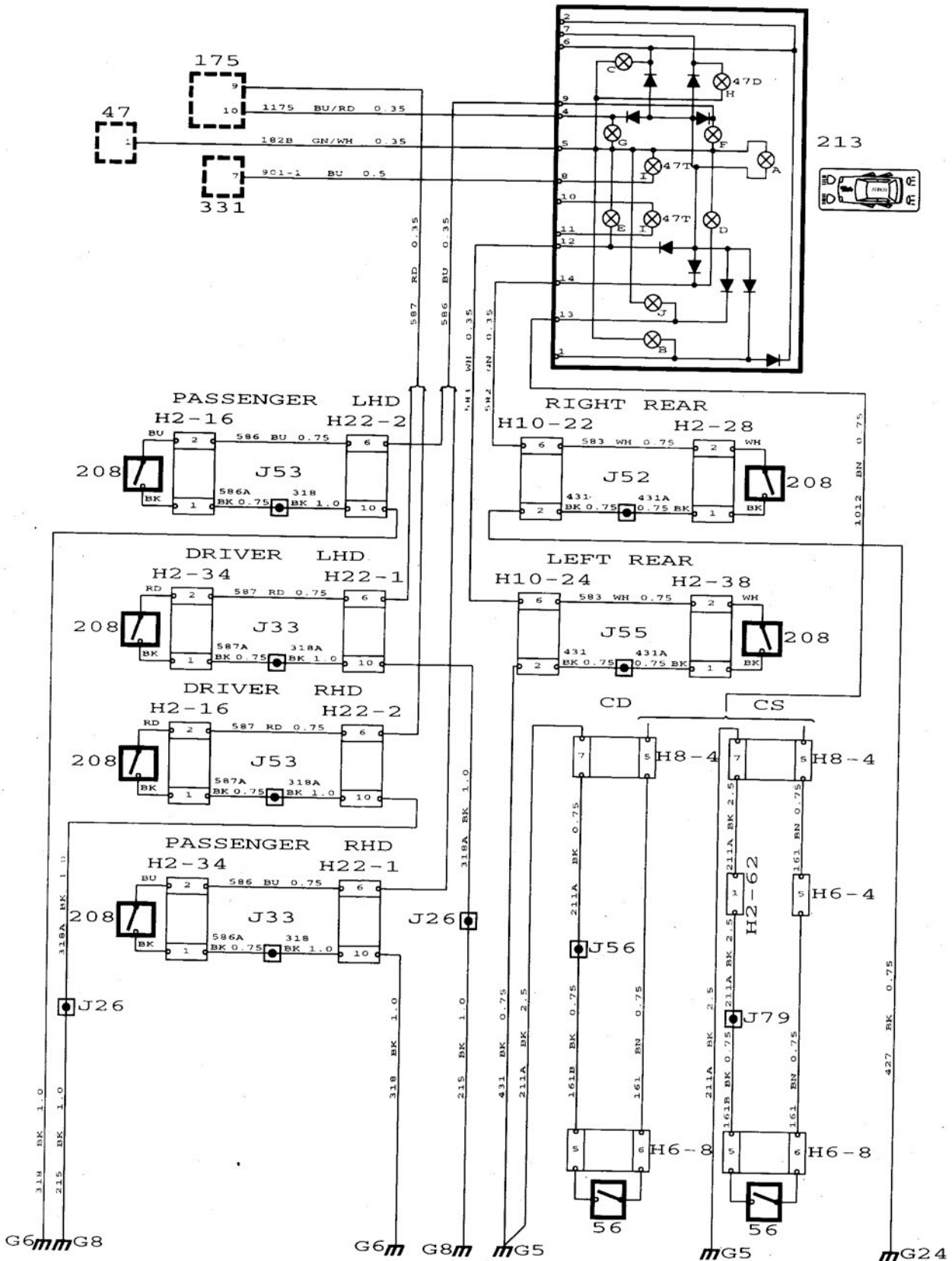

Description of operation

The part of pictogram 213 that covers door indication alerts the driver if any of the doors is not properly closed.

The filament monitor that is also covered by the pictogram is described in the previous section.

When the ignition switch is in the Drive position, positive current is supplied to terminal 5 of the pictogram and via lamps F, G, D, E and J for each door to the door switch in question.

If any door is not completely closed, door switch 208 will be closed and the circuit for the associated lamp is grounded, which means that the lamp lights up.

On right-hand drive cars, lead 587 is connected to pin 9 of the pictogram and lead 586 is connected to pin 10 of central locking system control module 175.

If the tailgate is not completely closed, luggage compartment switch 56 will be closed and lamp J light up.

Fault diagnosis hints

Door indication is activated by turning the ignition switch to the Drive position.

- 1 Check that current is supplied to terminal 5 of pictogram 213.
- 2 Check that the door switches are in proper working order.
- 3 Check that the luggage compartment lighting switch is in proper working order.
- 4 Check the connectors, wiring harness and ground connections.

Component locations

- 47 Main instrument display panel in the dashboard.
- 56 Luggage compartment lighting switch in the tailgate.
- 175 Control module, central locking system, on a bracket under the dashboard on the left-hand side.
- 208 Door lock indication, in the locking mechanism inside each door.
- 213 Pictogram, in the main instrument display panel.
- 331 SRS control module, in the front part of the centre console under the dashboard.
- 2-pin connectors*
- H2-16 Beside the locking mechanism inside the right-hand front door.
- H2-28 Beside the locking mechanism inside the right-hand rear door.
- H2-34 Beside the locking mechanism inside the left-hand front door.
- H2-38 Beside the locking mechanism inside the left-hand rear door.
- H2-62 In the tailgate on the left-hand side.
- 6-pin connectors*
- H6-4 To the left in the tailgate beside the rear window.
- H6-8 In the tailgate beside motor 188 (4D, CS).
- 8-pin connector*
- H8-4 By the left-hand rear wheel housing.
- 10-pin connectors*
- H10-22 In right-hand B pillar.
- H10-24 In left-hand B pillar.
- 22-pin connectors*
- H22-1 Behind the cable entry in the left-hand A pillar.
- H22-2 Behind the cable entry in the right-hand A pillar.
- G5 Grounding point, rear seat, under the left-hand part of the seat.
- G6 Grounding point, negative distribution terminal, in main fuse box behind the glove box.
- G8 Grounding point, dashboard, beside the front left-hand speaker socket.
- G24 Grounding point, on the right-hand front seat member.

Components

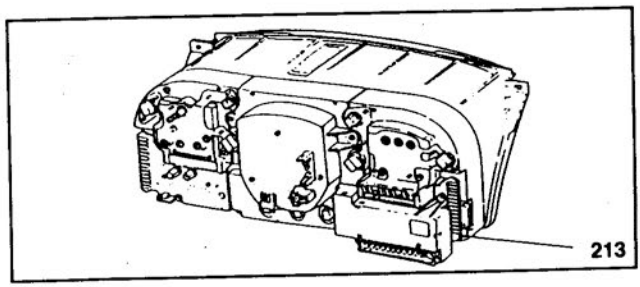
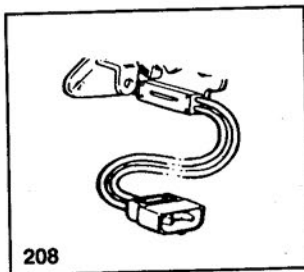
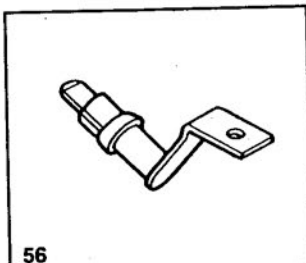
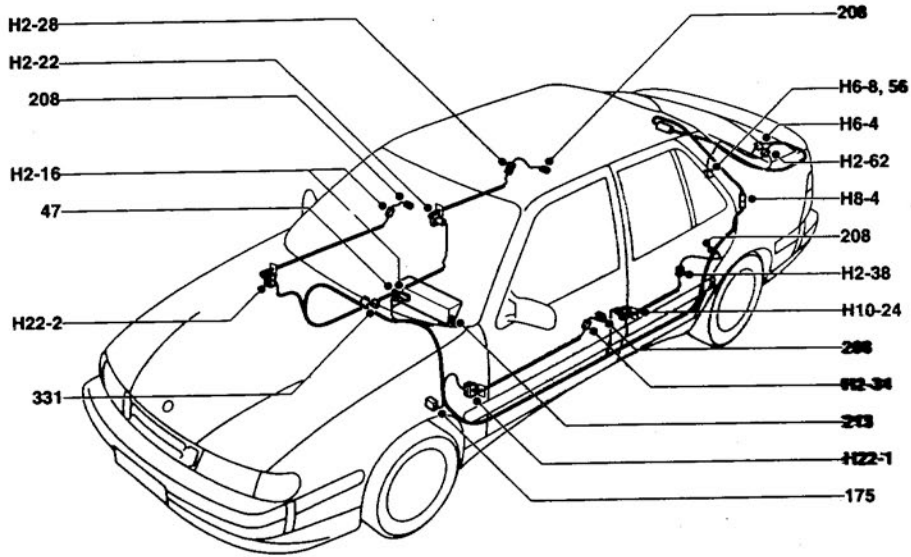

C381W-4543

Seat-belt warning without buzzer and ignition key warning

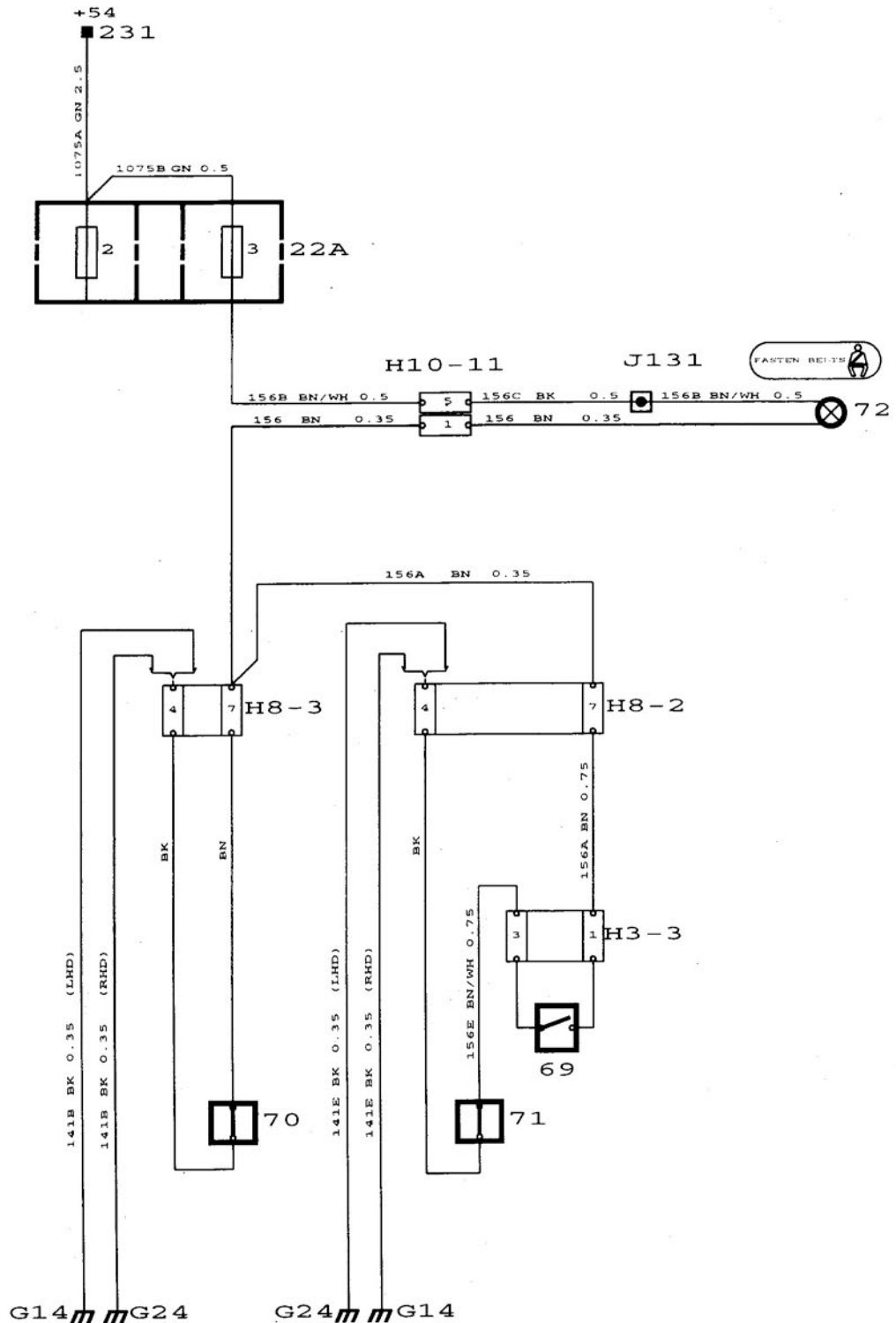

Seat-belt warning with buzzer and ignition key warning

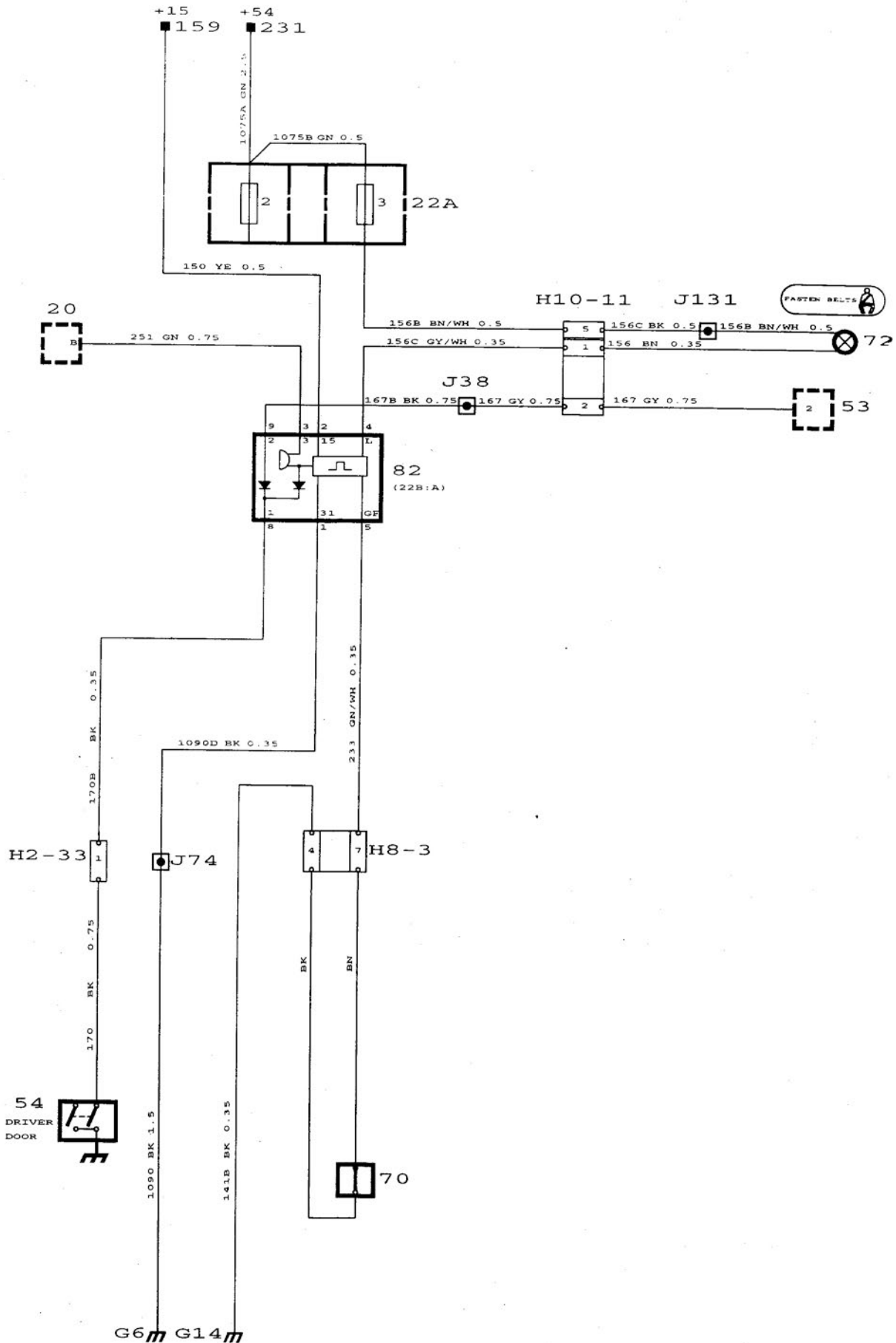

Description of operation

Seat-belt warning

With the ignition switch in the Drive position, current is supplied from fuse 3 via seat-belt warning lamp 72 to driver seat-belt warning switch 70. The switch grounds the warning lamp which then lights up. When the seat-belt is inserted in the seat-belt buckle, the switch breaks and the lamp goes out.

Seat switch 69 is connected in series with passenger seat-belt switch 71 and closes when the seat is loaded. The warning lamp is only activated if the passenger seat is occupied and the occupant is not wearing the seat belt.

The seat-belt buckles are illuminated by two lamps 224 which are supplied with current directly from fuse 3.

Seat-belt warning with buzzer and ignition key warning

The warning system alerts the driver if the seat belt is not fastened or if the car is left with the key in the ignition.

The system incorporates warning relay 82 which has a buzzer. When the ignition switch is in the Drive position, the relay is supplied with positive current via fuse 13.

Seat-belt warning:

When the ignition switch is in the Drive position, positive current is also supplied from fuse 3 via seat-belt warning lamp 72 to the warning relay.

If the belt is not fastened, the relay will be grounded by driver seat-belt warning switch 70. The warning lamp then lights up at the same time as the buzzer sounds. When the seat-belt is inserted in the seat-belt buckle, the switch opens and the light and buzzer go off.

Ignition key warning:

As long as the key remains in the ignition switch, current will be supplied from ignition switch terminal B to the warning relay.

If the key is still in the ignition switch when the driver's door is opened, door switch 54 will close. This grounds terminal 1 and causes the buzzer to sound.

Fault diagnosis hints

Activation of the seat-belt and ignition key warning takes place when the ignition switch is in the Drive position.

- 1 Check that fuse 3 is intact and supplied with current.
- 2 Check warning lamp 72.
- 3 Check that seat-belt switches 70 and 71 and seat switch 69 are in proper working order.
- 4 In regard to the seat-belt and ignition key warning with buzzer, also check that fuse 13 is intact and that current is supplied to the relay.
- 5 Check the wiring harness, connectors and ground connections.

Component locations

- 20 Ignition switch to the right of the steering column.
- 22A Fuse board behind the cover flap in the glove box.
- 53 Interior lighting switch, in the centre console beside the gear lever.
- 54 Door switch in each door pillar.
- 69 Seat switch, passenger seat-belt warning lamp, under the passenger's seat.
- 70 Driver seat-belt switch, between the driver and passenger seats.
- 71 Seat-belt switch, passenger, between the driver and passenger seats.
- 72 Seat-belt warning lamp, in the roof console above the interior rear-view mirror.
- 82 Warning relay, seat-belt/ignition key, in the main fuse box behind the glove box.
- 159 Distribution terminal (+15 circuit) in main fuse box behind the glove box.
- 231 Distribution terminal (+54 circuit) in main fuse box behind the glove box.
- 2-pin connector*
- H2-33 In the left-hand A pillar.
- 3-pin connector*
- H3-3 Under the right-hand seat.
- 8-pin connectors*
- H8-2 Under the right-hand seat.
- H8-3 Under the left-hand seat.
- 10-pin connector*
- H10-11 On the far left under the dashboard, behind the knee shield.
- G6 Grounding point, negative distribution terminal, in main fuse box 22B behind the glove box.
- G14 Grounding point, left-hand seat member, under the left-hand seat.
- G24 Grounding point, right-hand seat member, under the right-hand seat.

Components

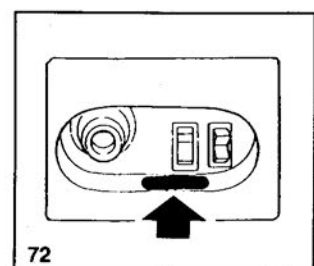
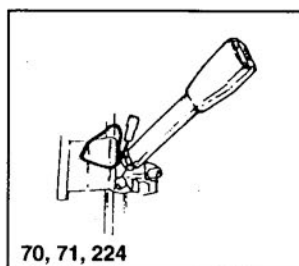
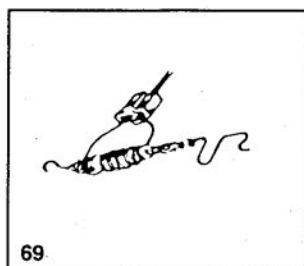
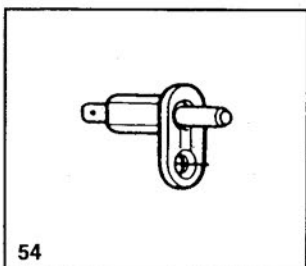
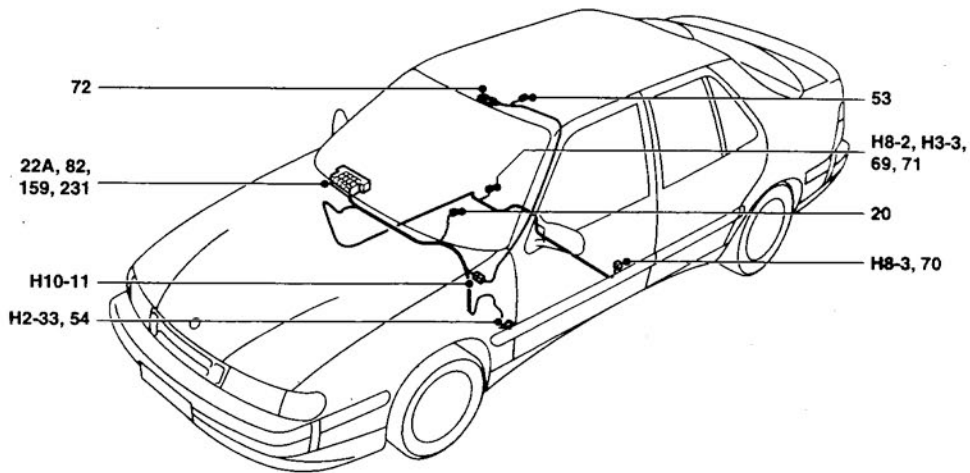

C853W-4544

Horn

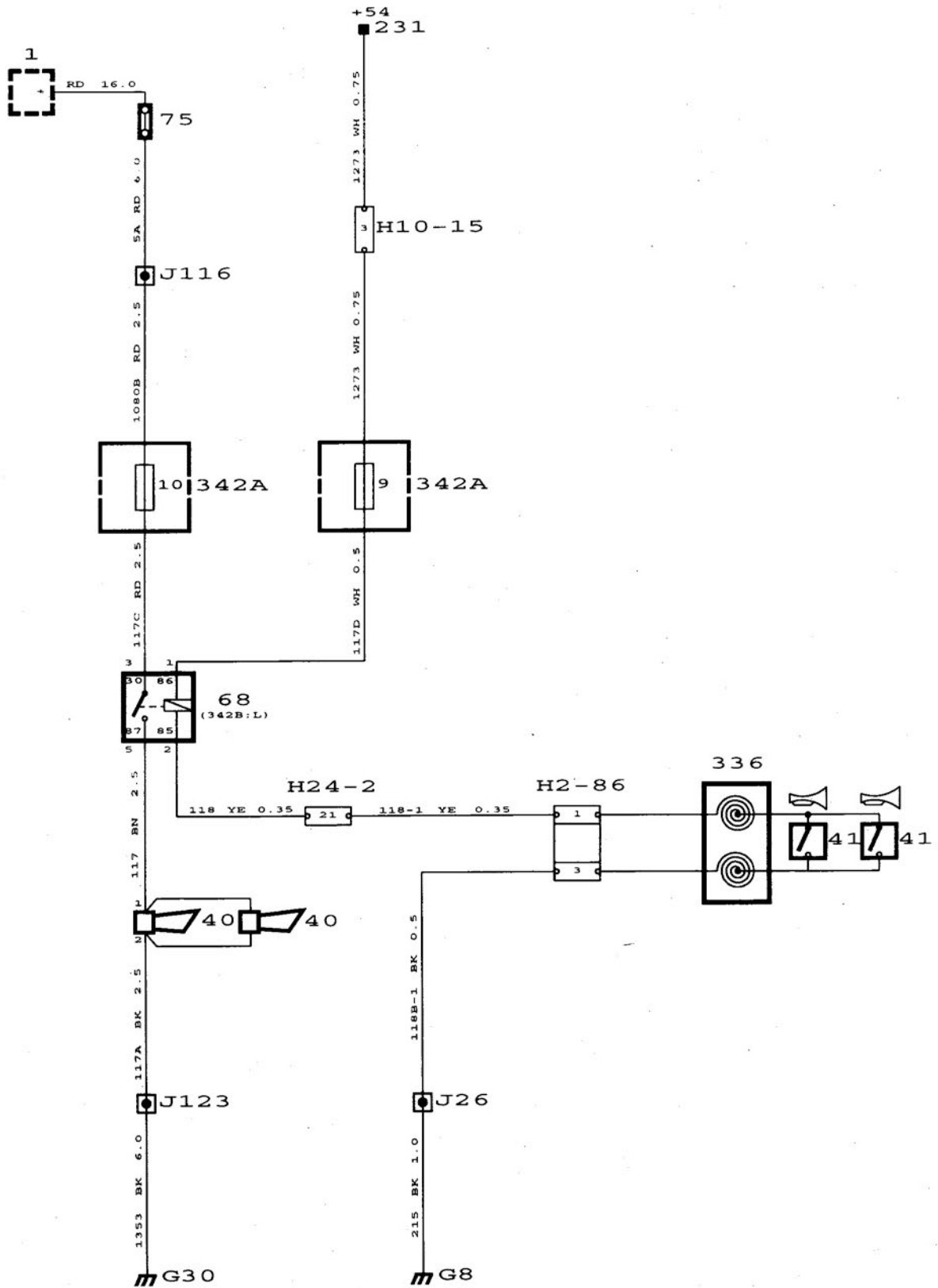

Description of operation

Horn

The horn system includes two tuned horns of loud-tone type. One has a high pitch and the other a low pitch.

Positive current is supplied from fuse 10 in the main fuse box via the actuating coil in horn relay 68 to the horn switch on the steering wheel. When the horn switch is closed, the relay operates and horn 40 is supplied with current via fuse 9 and the relay contacts.

Fault diagnosis hints

The horn is operative when the ignition switch is in the Drive position.

- 1 Check that fuses 9 and 10 are intact and supplied with current.
- 2 Check the operation of the horn by grounding it. The horn should then sound.
- 3 Check the connectors, wiring harness and ground connections.

Component locations

1	Battery.
40	Horn CD: one is located behind the front grille and one behind the bumper on the left-hand side. CS: one is located behind the bumper on the right-hand side and one behind the front grille.
41	Horn switch behind the steering wheel centre pad.
68	Horn relay, in main fuse box in front of the battery.
75	Distribution block, battery positive, on the battery tray.
231	Distribution terminal (+54 circuit) in main fuse box behind the glove box.
336	Switch module, airbag (coil spring), on the steering gear under the steering wheel.
342A	Main fuse box in the engine bay in front of the battery. <i>2-pin connector</i>
H2-86	In the steering wheel, for the horn button. <i>10-pin connector</i>
H10-15	Behind the left-hand headlamp. <i>24-pin connector</i>
H24-2	Behind the left-hand headlamp.
G8	Grounding point, dashboard, by the left-hand front loudspeaker socket.
G30	Grounding point, left-hand structural member behind the left-hand headlamp.

Components

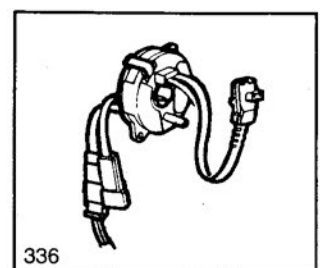
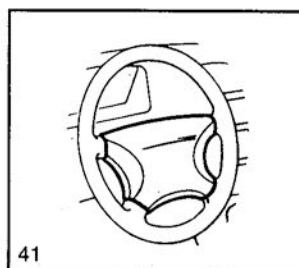
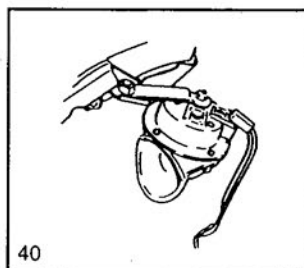
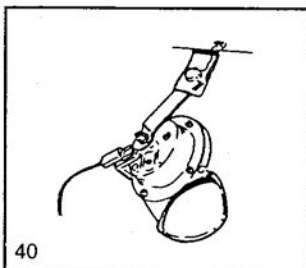
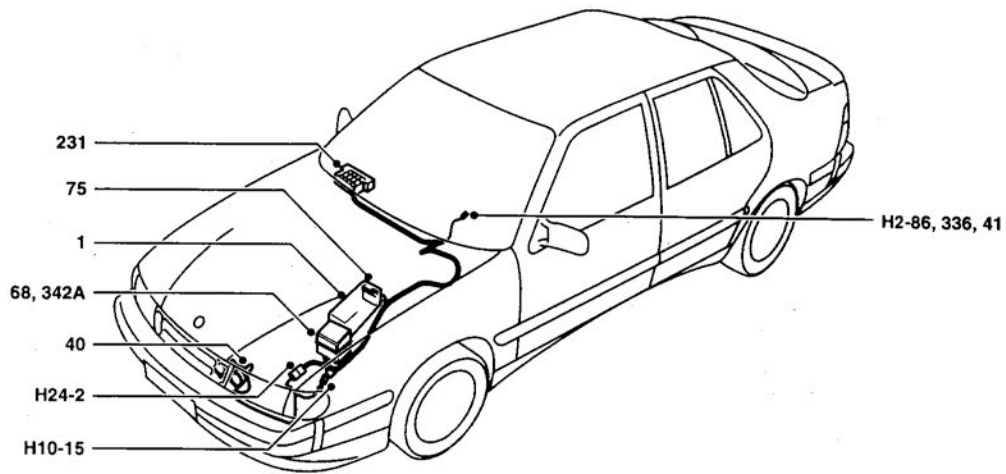

C381W-4545

EXH warning

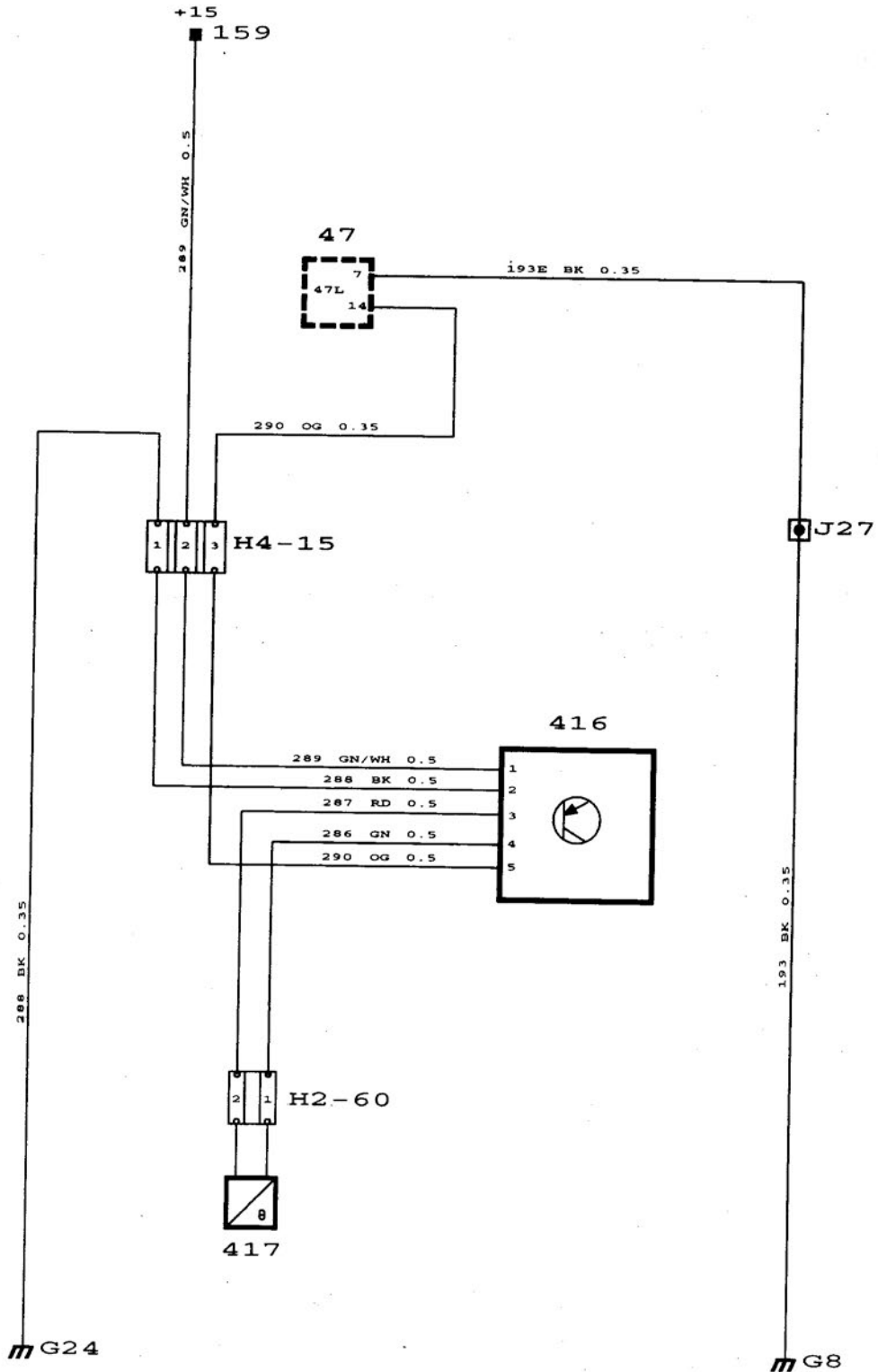

Description of operation

Cars for certain markets are equipped with a monitoring system for catalytic converter overheating. The system consists of:

- Temperature sensor 417
- Electronic relay 416
- Warning lamp 47L

When the three-way catalytic converter temperature rises to between 800°C and 850°C, the warning lamp lights up and remains alight until the temperature drops by about 10°C.

When current (+15 circuit) is applied to relay pin 1, the warning lamp is grounded and lights up for about 3 seconds. The lamp does not light up again unless the temperature of the three way catalytic converter exceeds the limit value.

As the temperature rises, the current between pins 3 and 4 of the temperature sensor changes. When the change in the resistance of the sensor is sufficiently large, the relay function is activated and the warning lamp lights up.

Similarly, the warning lamp goes out when the temperature drops or when the supply current (+15 circuit) is broken, i.e. when the ignition is switched off.

Fault diagnosis hints

When current (+15 circuit) is applied to relay pin 1, the warning lamp is grounded and lights up for about 3 seconds.

If the lamp stays on, there is a break in the temperature sensor circuit. Normally, the warning lamp goes out and does not light up unless the temperature exceeds the limit value.

- 1 Check that fuse 13 is intact and that current is supplied to the temperature sensor and relay.
- 2 Also check the connectors, wiring harness and ground connections.

Component locations

- 47L EXH warning lamp, in the main instrument display panel.
- 159 Distribution terminal (+15 circuit) in main fuse box behind the glove box.
- 416 Relay, EXH warning, located on a bracket behind the front seat member on the right-hand side.
- 417 Temperature sensor, EXH, on the three-way catalytic converter.
2-pin connector
- H2-60 To the left under the right-hand front seat.
4-pin connector
- H4-15 To the left under the right-hand front seat.
- G8 Grounding point, dashboard, by the left-hand front loudspeaker socket.
- G24 Grounding point, right-hand seat member, under the front right-hand seat member.

Components

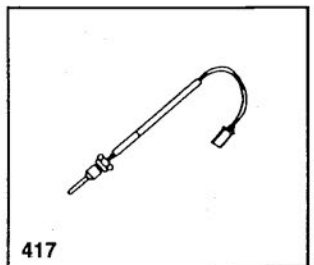
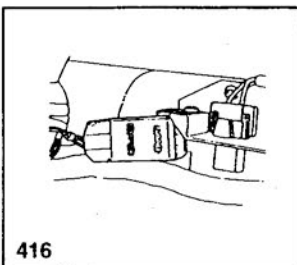
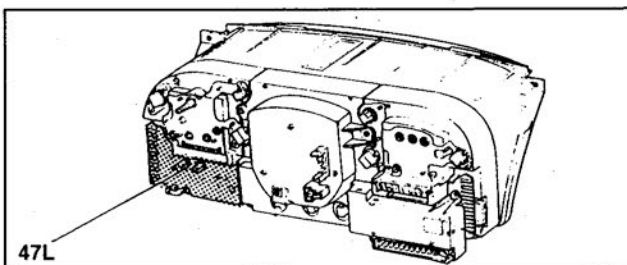
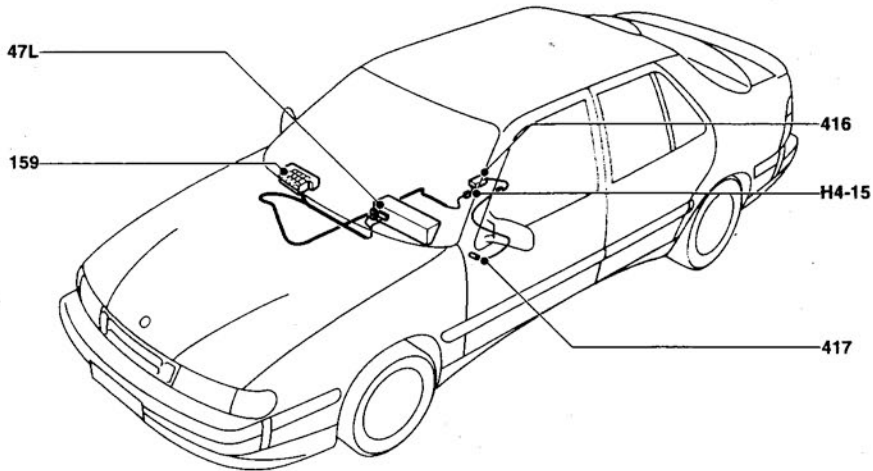

C381W-4546

Air conditioning, A/C

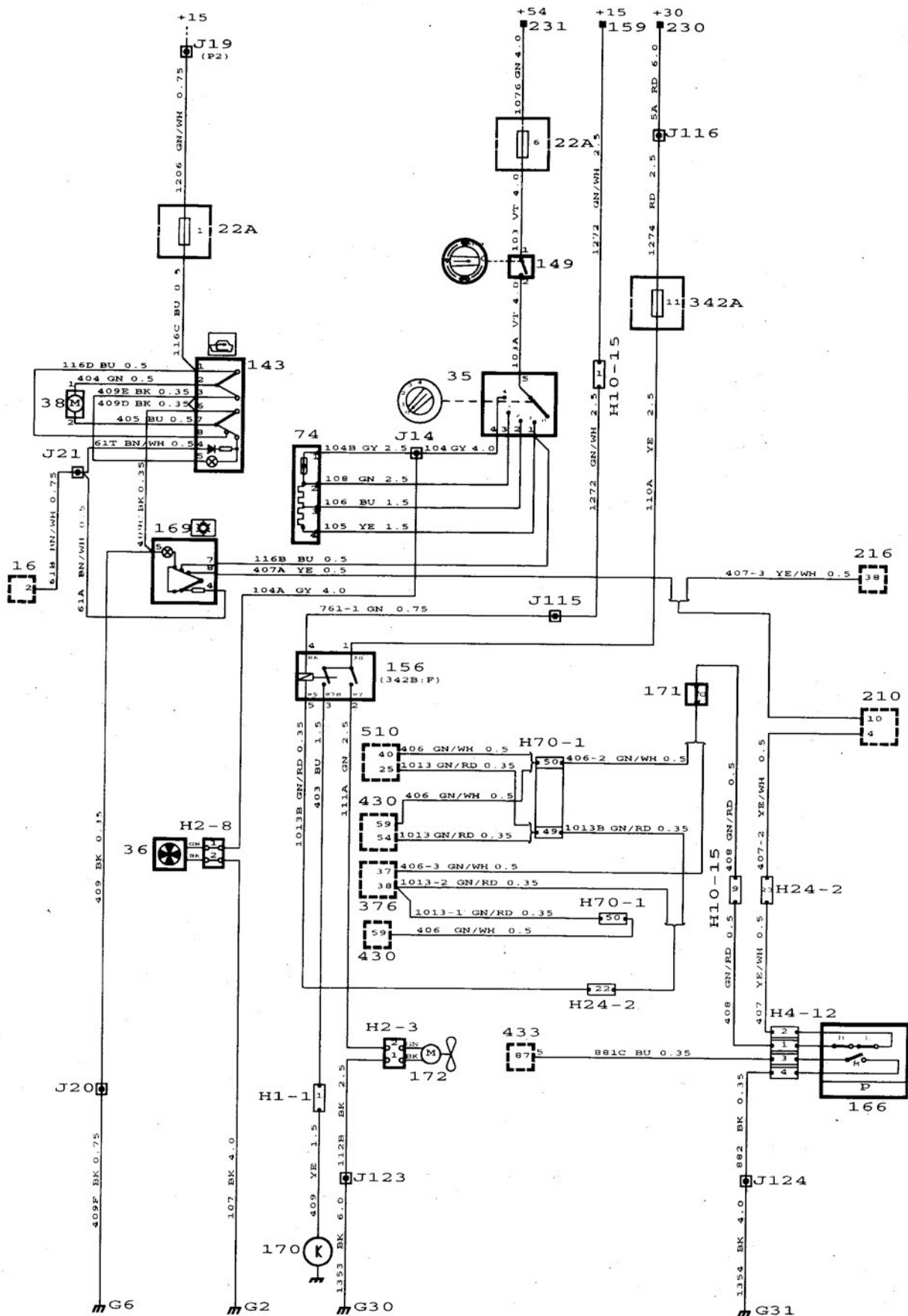

General

All cars with ACC and certain cars with a heating and ventilation system are equipped with air conditioning (A/C).

The A/C system is switched on and off with A/C switch 169 or from ACC panel 216 via EDU 210. Compressor 170 and auxiliary A/C radiator fan 172 are activated with relay 156.

The following conditions must be met in order for switch 169 to receive current from fuse 6:

- Main ventilation fan switch 149 closed, i.e. air distribution control open.
- Ventilation fan on, i.e. switch 35 in any of positions 1-4.

As soon as switch 169 is depressed, the integrated lamp is supplied with current. When the switch is not depressed, the lamp is supplied with current from rheostat 16.

For relay 156 to operate and start the A/C compressor, the following conditions must be met:

- Contacts H and L in pressure switch 166 must be closed (normal position).
- Antifrost thermostat 171 must be closed, that is to say the ambient temperature must be at least +6°C (+43°F).
- Engine coolant temperature must be below 119°C (247°F) in a 4-cylinder engine and 116°C (240°F) in a V6 engine. The temperature is measured by the EDU control module.

If these conditions are met, operating current is supplied from EDU control module pin 4 via pressure switch 166 and antifrost thermostat 171 to the car's engine management system which in turn grounds relay 156. Compressor 170 and radiator fan 172 start. When the evaporator temperature drops towards freezing point, the antifrost thermostat opens and the engine management system disconnects relay 156. The compressor and radiator fan stop. The temperature of the evaporator starts to rise and when it reaches the antifrost switching point, relay 155 is again grounded and the compressor and radiator fan start up once more.

When the system is cycling, the output cooling effect is less than what the A/C system is capable of producing. High fan speed, high outside temperature and the speed of the car are factors which strongly influence the ability of the system to reach the cycling point.

Description of operation

Pressure switch 166

Switches L and H are safety switches for low and high refrigerant pressure respectively. They are normally closed, but L opens if the pressure drops below about 2 bar. When the outside temperature is below 0°C (32°F), the pressure will not become higher and switch L deactivates the system.

If the refrigerant pressure exceeds 27 bar, switch H opens and the system is deactivated.

Antifrost thermostat 171

When the temperature of the evaporator drops to 2.0 +/- 1.1°C (35.5 +/- 2°F), the thermostat trips and then closes when the temperature reaches 3°C (5°F) above the tripping temperature.

Engine management system

To prevent engine speed from dropping when the compressor is engaged, the control module compensates for the load by raising the idling speed.

Regular engine radiator fan 37 or 366 is controlled via contact M in pressure switch 166. The switch is normally open when the system is switched on. When the refrigerant pressure reaches 16 bar, the switch closes and relay 155 operates, thus starting the fan motor.

The switch then goes on and off, depending on the cooling. Switch-off occurs at 12 bar.

For connection of radiator fan 37 or 366, see the **Cooling system** wiring diagram on page 51.

Trionic without ETS

In the Trionic system without ETS, operating current is supplied from antifrost thermostat 171 to pin 59. Control module 430 grounds relay 156 via pin 54.

Trionic with ETS

In Trionic with ETS, operating current is supplied from antifrost thermostat 171 to pin 37 of ETS control module 376. ETS control module pin 38 grounds relay 156 at the same time as Trionic control module pin 59 is grounded.

Motronic 2.8.1

In the Motronic system, current is supplied from antifrost thermostat 171 to pin 40 of control module 510. Pin 25 of this module grounds relay 156.

Recirculation motor

When switch 143 is pressed, motor 38 turns the air recirculation flap to the recirculation position, i.e. no fresh air is supplied to the cabin. When the switch is released by being pressed again, the motor returns to fresh air mode.

The switch is supplied with current via fuse 1. Its integral lamp lights up at full intensity when in the depressed position.

Fault diagnosis hints

In general, the system is supplied with current when the ignition switch is in the Drive position. If no faulty component can be detected, check the wiring harness, connectors and ground connections.

A/C compressor and A/C radiator fan

- 1 Check fuses 11 and 6 and check that current is supplied to the A/C switch and relay 156.
- 2 Depress the A/C switch. Check that current is supplied to EDU control module 210 and from there on to pressure switch 166 and check that this closes under the conditions mentioned.

Important:

The refrigerant sprays out if the pressure switch is removed.

 **WARNING**

Risk of frost and eye injuries

Check antifrost thermostat 171. The temperature should be at least +6°C (+43°F) for the switch to close the circuit.

Engine management system Check that the relay operates and that current is supplied to the relay contacts. If this is not the case, check that the coil is supplied with current from the terminal block (+15 circuit) and that it is grounded in the relevant control module.

Recirculation

- 1 Check that fuse 1 is intact and supplied with current.
- 2 Check that current is supplied to terminal 2 of switch 143 when it is **not** depressed (recirculation not activated).
- 3 Check that current is supplied to terminal 7 of switch 143 when it **is** depressed (recirculation activated).

Component locations

16	Rheostat, lighting for controls, on dashboard between the steering wheel and driver's door.	430	Saab Trionic contrl module, in engine bay on the left-hand side behind the bulkhead partition.
22A	Fuse board behind the cover flap in the glove box.	433	Relay, disengagement of radiator fan, in main fuse box in front of the battery.
35	Switch, ventilation fan, on the control panel for heating and ventilation.	510	Motronic 2.8.1 control module, in engine bay behind the bulkhead partition. <i>1-pin connector</i>
36	Ventilation fan motor, in fan housing between the evaporator casing and heater housing.	H1-1	On the A/C compressor connection furthest forward on the right-hand side, above the manifold. <i>2-pin connector</i>
38	Motor, air recirculation flap, on the evaporator casing.	H2-3	To the left behind the front grille beside the left-hand headlamp. <i>4-pin connector</i>
74	Resistor, ventilation fan, in the fan housing frame beside the cable connection.	H4-12	Beside the right-hand wheel housing adjacent to the receiver. <i>10-pin connector</i>
143	Switch, A/C air recirculation, on the dashboard between the centre console and steering wheel.	H10-15	Behind the left-hand headlamp. <i>24-pin connector</i>
149	Main switch, fan, on rear of the control panel for heating and ventilation.	H24-2	Behind the left-hand headlamp. <i>70-pin connector</i>
156	Relay, A/C compressor, in main fuse box in front of the battery.	H70-1	In the engine bay, behind the bulkhead partition.
159	Distribution terminal (+15 circuit) in main fuse box behind the glove box.	G2	Grounding point, behind the battery on the left-hand wheel housing.
166	3-stage pressure switch for radiator fan, on the receiver in front of the right-hand wheel housing.	G6	Grounding point, negative distribution terminal, in the main fuse box (22B) behind the glove box.
169	Switch, A/C, on dashboard between the steering wheel and centre console.	G30	Grounding point on the left-hand structural member behind the left-hand headlamp.
170	Compressor, A/C, furthest forward on the right above the manifold.	G31	Grounding point, right-hand structural member behind the right-hand headlamp.
171	Antifrost thermostat on the evaporator casing below the windscreen on the right-hand side.		
172	Radiator fan, A/C, to the right behind the front grille in front of the condenser.		
210	EDU trip computer, in the main instrument display panel.		
216	ACC control module, in the centre of the dashboard.		
230	Distribution terminal (+30 circuit) in main fuse box behind the glove box.		
231	Distribution terminal (+54 circuit) in main fuse box behind the glove box.		
342A	Main fuse box in front of the battery.		
376	ETS throttle control module, under left-hand front seat.		

Components

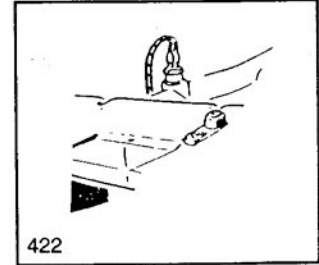
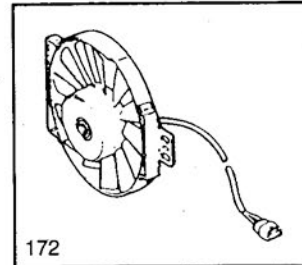
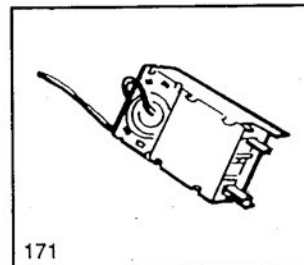
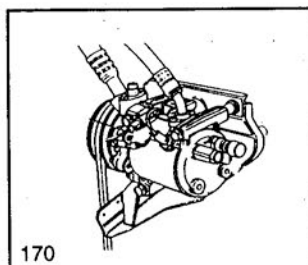
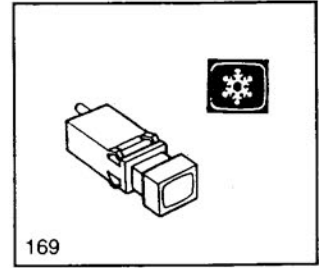
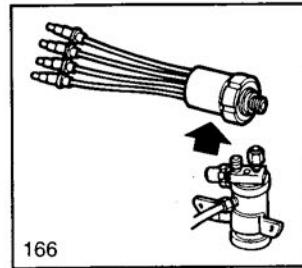
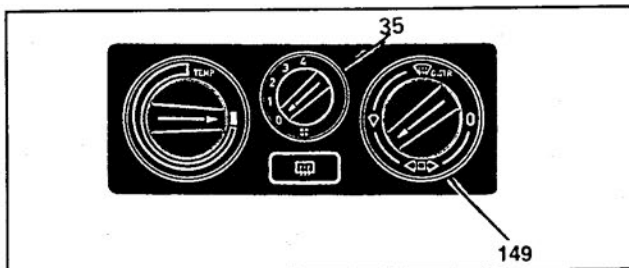
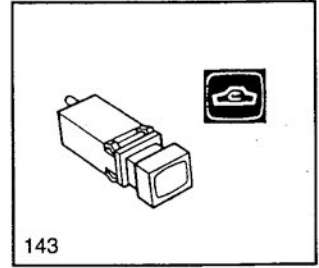
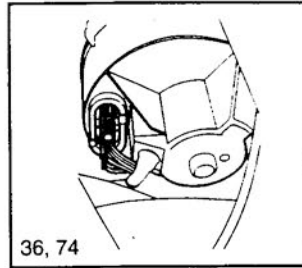
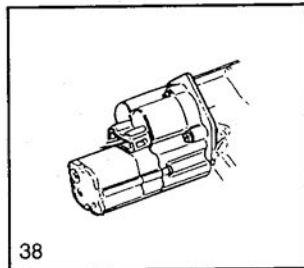
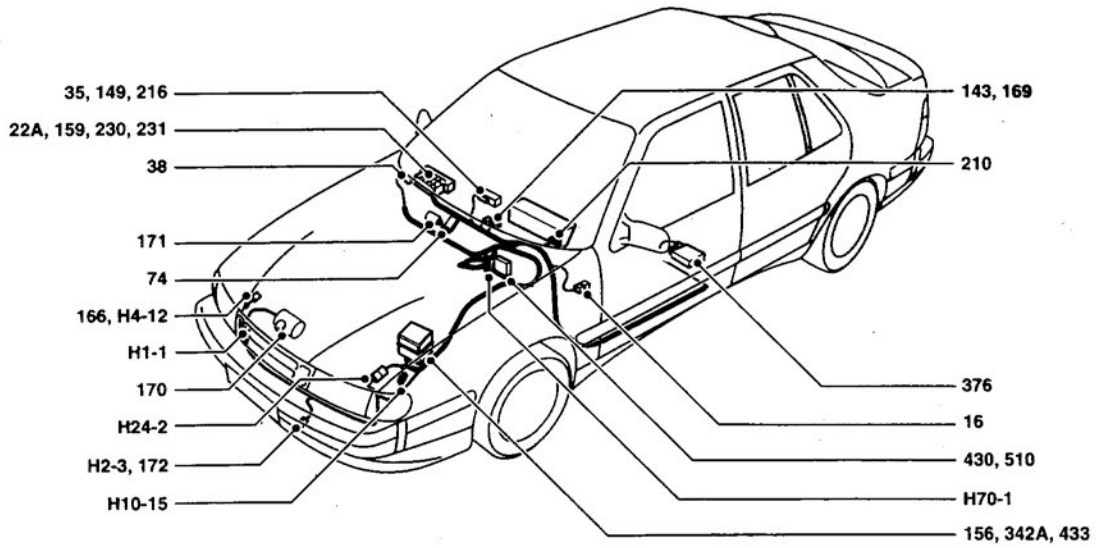

C870W-4547

Automatic Climate Control, ACC

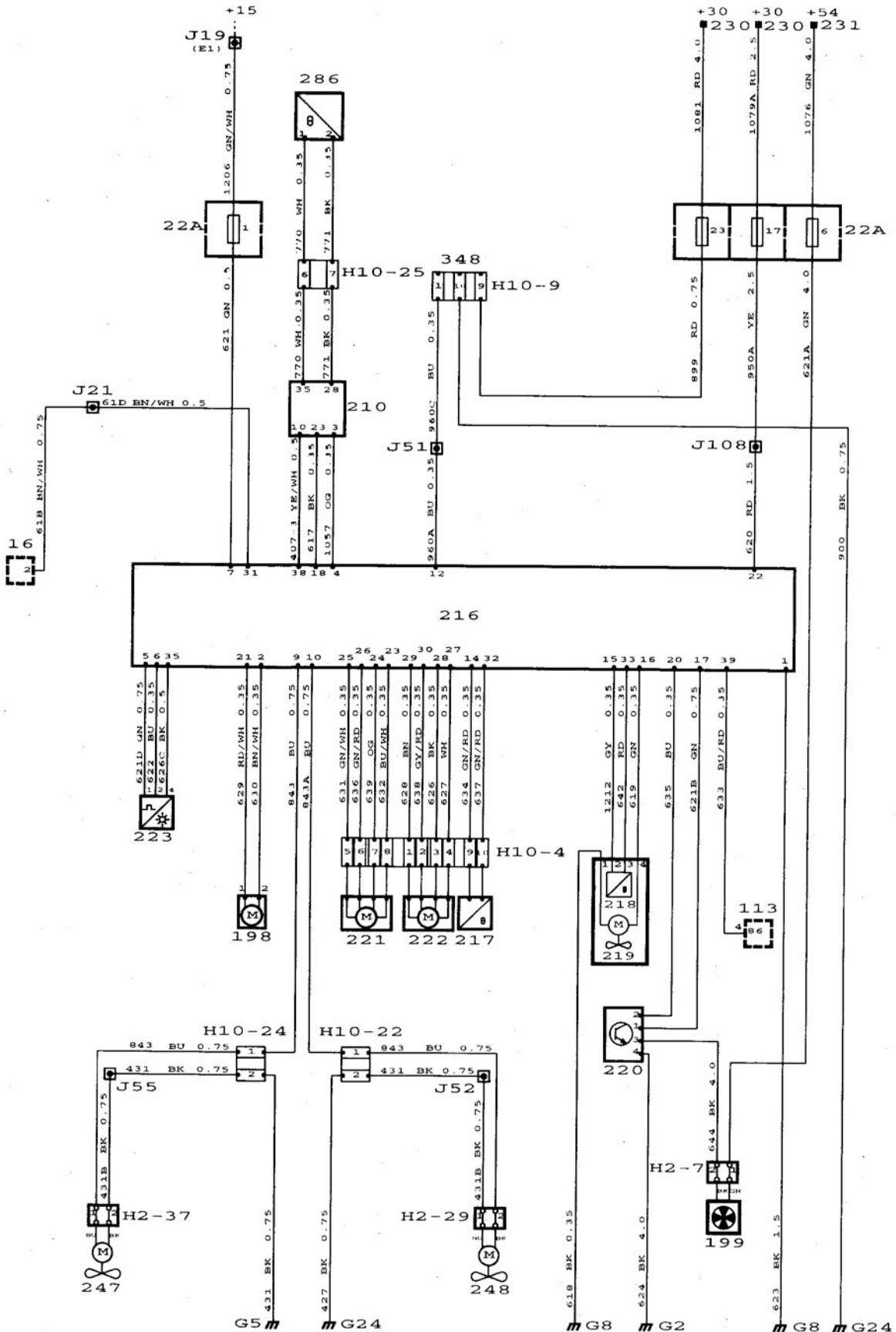

General

Some cars are equipped with an automatic climate control (ACC) system. The heating and ventilation system (including A/C) is then controlled automatically so that the desired temperature in the cabin is maintained at all times, regardless of the outside temperature. Air conditioning (A/C) with a recirculation mode is always included in the ACC system.

The climate control unit has the following functions:

- Automatic temperature control, including automatic control of recirculation.
- Rear door fans.
- Electrically heated rear window.
- Electrically heated door mirrors.

The A/C compressor is deactivated using the ECON button while the other functions are still controlled automatically.

The system can be switched off with the OFF button.

By pressing one of the buttons on the right of the unit, the particular function is manually switched on. If the button is pressed again, the function returns to the programmed mode.

Light-emitting diodes show which parts of the ventilation system are active, irrespective of whether the system is on automatic or under manual control.

To enable the system to achieve the required temperature in the cabin, data is required from a number of sensors, actuator motors, etc.

Description of operation

The climate control unit obtains data from both the control panel and the following sensors:

Cabin temperature sensor 218

Interior temperature sensor 218 is an NTC resistor which senses the temperature of the cabin air. The sensor has an integrated suction fan, 219, which gives an even air flow around the sensor. The sensor is connected via pins 15 and 33 while the suction fan is supplied with 12 V via pin 16.

Blended air temperature sensor 217

The blended air temperature sensor is an NTC resistor which senses the temperature immediately after the air-mixing damper. The sensor is connected via pins 14 and 32.

Solar sensor 223

The solar sensor consists of five solar cells arranged in a cube under the black cover. Pulses are sent to the solar sensor from ACC pin 5. Digital pulses are sent to ACC control module pin 6 via an amplifier stage.

Outside temperature.

The outside temperature is obtained in the form of digital pulses from EDU trip computer 210 on pin 18 of the ACC control module.

Power supply

Climate control unit 216 is supplied with current via fuses 17 and 1.

The unit always receives current directly from the battery via fuse 17. This is the main supply for the system.

When the ignition switch is in the Drive position, the unit is also supplied with current via fuse 1. At the same time, suction fan 219 for interior temperature sensor 218 starts.

Ventilation fan 199 is supplied with current via fuse 6.

Pin 31 of the unit is connected to instrument lighting rheostat 16.

Climate control unit 216

The unit controls the following functions/units:

- Ventilation fan 199 via speed control 220. Control of the speed is stepless. Control module pin 17 supplies the speed control with 12 V. A speed control voltage of 0-5 V is supplied via pin 20 where 0 V = fan stationary and 5 V = full speed.
- Stepping motor 222 for the air-mixing damper which controls the flow of air, directing it through the heat exchanger or bypassing it. The motor is connected to pins 27, 28, 30 and 29.
- Stepping motor 221 for the air-mixing damper which controls the air flowing through the defroster and/or ventilation outlet. The motor is connected to pins 23, 24, 26 and 25.
- Servo motor 198 for the air recirculation flap. When the flap is closed, air is taken from outside and when it is open (air recirculation position), air is taken from the cabin. The motor is connected to pins 2 and 21 on the unit.
- Electrically heated rear window 115 and heating element 207 in the door mirrors, which are controlled via relay 113. The relay is connected to pin 39. Connections to the relay are shown in detail in the section entitled **Electrically heated rear window**, on page 285.
- Rear door fans 247 and 248 are connected to pins 9 and 10 respectively.

Important:

The cooling fin on the speed control is live (+12 V) when the ignition is on. If the cooling fin is grounded, the speed control will be rendered unserviceable.

Fault diagnosis hints

When taking readings and during fault diagnosis, the connector must be removed. All readings must be taken on the connector and not on the climate control unit. With the exception of changing bulbs, the unit must not be tampered with.

Self-diagnostics

There is a special self-test program in the climate control unit's microprocessor.

The program regularly checks certain functions during driving, and an emergency program is activated if there is a fault in any of the sensors.

Faults detected by the self-test program are stored as diagnostic trouble codes in the memory of the microprocessor. Diagnostic trouble codes are read using the ISAT scan tool.

Calibration

The flap actuator motors must be calibrated at the following times:

- After changing the control panel.
- After changing the flap motors.
- If the battery has been removed within 30 seconds of the ignition being switched off.
- If the battery has been discharged or if battery positive voltage has been higher than 16 V.

Calibration is carried out either by simultaneously pressing the AUTO and $\langle \square \rangle$ buttons or by means of the ISAT scan tool.

A self-test is carried out in conjunction with calibration. The total time for calibration and self-test is 22-50 seconds. The number of faults (0-5), if any, is shown in the display during the first 35 seconds.

A full description of obtaining readouts of diagnostic trouble codes with the ISAT scan tool, how they should be interpreted and a description of calibration will be found in Service Manual "8:3 Climate Control System, ACC II". It also contains a description of customer adaptation that can be performed.

Other fault diagnosis

- 1 Check that the relevant fuses are intact and supplied with current.
- 2 Check the interior temperature sensor suction fan by allowing a thin piece of paper to be sucked onto the intake.
- 3 Check the climate control unit connectors. Clean by unplugging and plugging them in again.
- 4 Check the connectors, wiring harness and ground connections.

For checking A/C compressors and radiator fans, see the section entitled **Air Conditioning, A/C** on page 265.

Resistances, blended air temperature sensor

	Minimum (kohm)	Maximum (kohm)
$\pm 0^{\circ}\text{C}$	25,5	30,5
+ 10°C	16,6	19,6
+ 20°C	11,2	13,0
+ 30°C	7,7	8,8
+ 40°C	5,4	6,1

Interior temperature sensor

	Minimum (kohm)	Maximum (kohm)
$\pm 0^{\circ}\text{C}$	30,0	34,8
+ 10°C	18,5	21,1
+ 20°C	11,7	13,1
+ 25°C	9,5	10,5
+ 30°C	7,6	8,5
+ 40°C	4,9	5,6

Component locations

16	Rheostat, lighting for controls, on dashboard between the steering wheel and driver's door.		<i>2-pin connectors</i>
22A	Fuse board behind the cover flap in the glove box.	H2-7	Adjacent to ventilation fan motor 199.
113	Relay, electrically heated rear window, in the main fuse box behind the glove box.	H2-29	In the right-hand rear door beside the fan motor.
198	Motor, air recirculation flap, on the evaporator casing.	H2-37	In the left-hand rear door beside the fan motor.
199	Motor, ACC ventilation fan, in fan housing between the evaporator casing and heater housing.		<i>10-pin connectors</i>
210	EDU trip computer in the main instrument display panel.	H10-4	Behind the glove box on the ACC servo motor unit.
216	ACC control module, in the centre of the dashboard.	H10-22	In right-hand B pillar.
217	ACC blended air temperature sensor, under the servo motor unit.	H10-24	In left-hand B pillar.
218	ACC interior temperature sensor, on the dashboard between the steering wheel and centre console.	H10-25	Behind the left-hand headlamp.
219	Suction fan, ACC interior temperature sensor, on the dashboard between the steering wheel and centre console.	G2	Grounding point, battery tray, on the left-hand wheel housing.
220	Speed control, ventilation fan, in the evaporating casing where it joins the fan housing.	G5	Grounding point, rear seat, under the left-hand part of the seat.
221	Motor, ACC air distribution damper, on the servo motor unit behind the glove box.	G8	Grounding point, dashboard, by the left-hand front loudspeaker socket.
222	Motor, ACC temperature valve, on the servo motor unit behind the glove box.	G24	Grounding point, right-hand front seat member.
223	ACC solar sensor, on the top of the dashboard in the middle.		
230	Distribution terminal (+30 circuit) in main fuse box behind the glove box.		
231	Distribution terminal (+54 circuit) in main fuse box behind the glove box.		
247	Motor, door fan, in the left-hand rear door.		
248	Motor, door fan, in the right-hand rear door.		
286	Outside temperature sensor, EDU/SCC, to the left behind the front spoiler.		
348 (10-9)	Data link connector, under the right-hand seat (green).		

Components

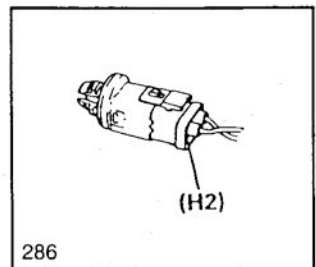
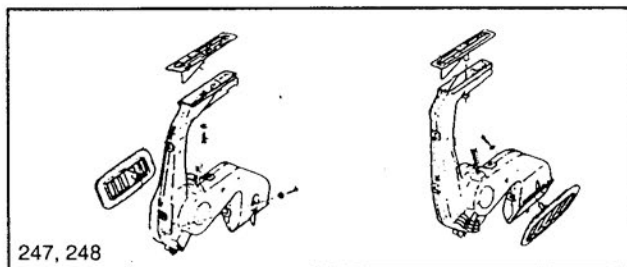
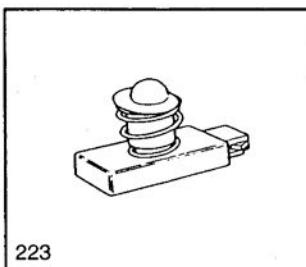
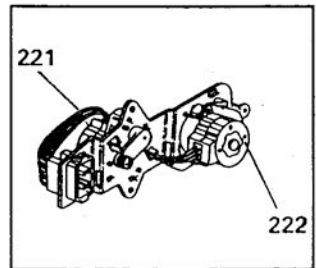
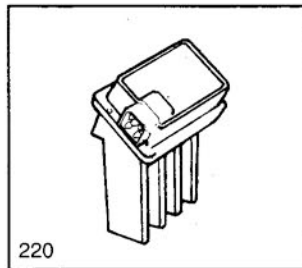
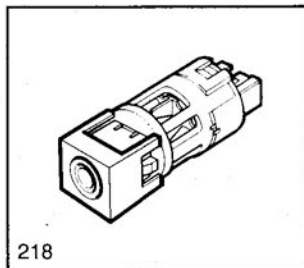
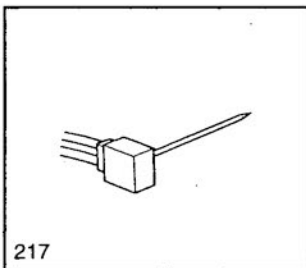
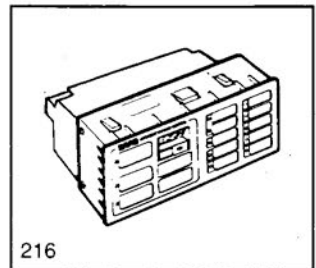
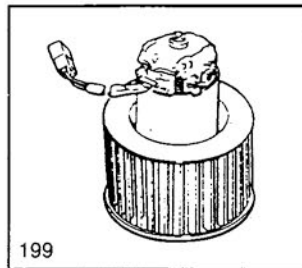
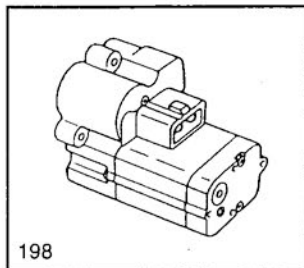
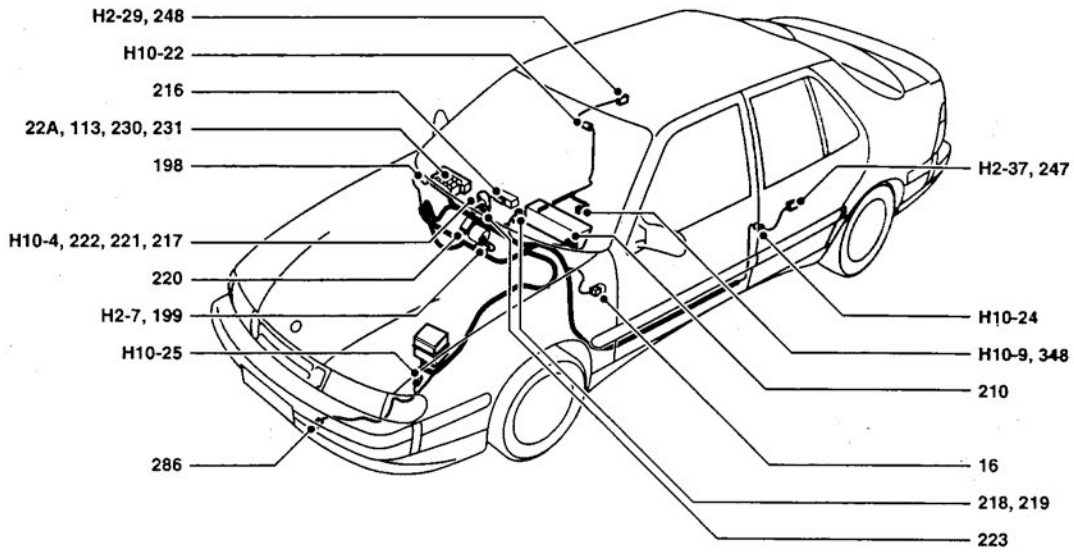

CB70W-4548

Ventilation fan

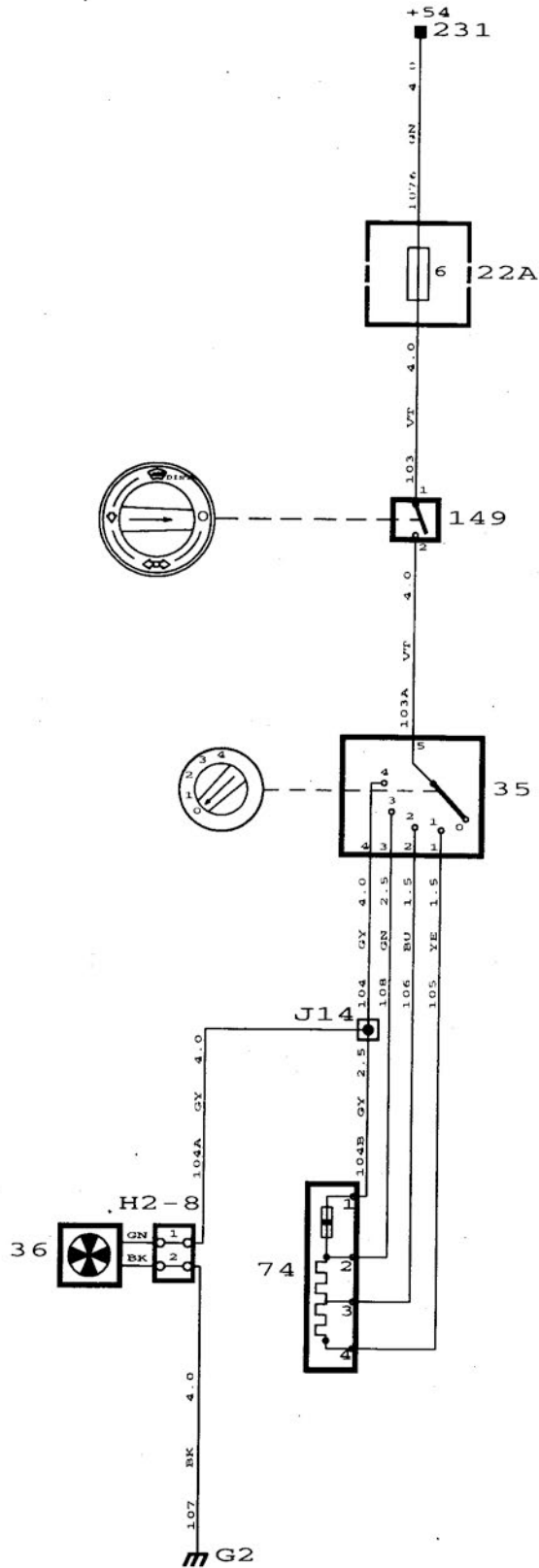

Description of operation

Current is supplied from fuse 6 to main fan switch 149 and on to ventilation fan switch 35. The main switch is controlled by the air distribution control and breaks the circuit when the control is in position 0.

The fan selector switch, which acts on fan motor 36 through resistor 74, can be set to four fan speeds. In position 1, the entire resistance is connected, which gives the lowest fan speed. In position 4, the resistance is bypassed, which gives the highest fan speed.

The resistor is equipped with a fuse which blows in the case of overload.

Fault diagnosis hints

The ventilation fan is activated when the ignition switch is turned to the Drive position.

- 1 Check that fuse 6 is intact and supplied with current.
- 2 Check the current supplied to switch 35 and main switch 149.

Important:

Main switch 149 is located in the air distribution control. This must be activated in order for switch 35 to receive current.

Turn switch 35 to different positions and check the current supplied to motor 36.

Resistances across resistor 74

Speed 1	3.1 ± 0.3 ohms
Speed 2	1.15 ± 0.1 ohms
Speed 3	0.35 ± 0.1 ohms

Check the connectors, wiring harness and ground connections.

Component locations

- 16 Rheostat, lighting for controls, on dashboard between the steering wheel and driver's door.
- 22A Fuse board behind the cover flap in the glove box.
- 35 Switch, ventilation fan, on the control panel for heating and ventilation.
- 36 Motor, ventilation fan, in the fan housing between the evaporator casing and heater housing.
- 74 Resistor, ventilation fan, in the fan housing frame beside the cable connection.
- 149 Main switch, fan, on rear of the control panel for heating and ventilation.
- 231 Distribution terminal (+54 circuit) in main fuse box behind the glove box.
2-pin connector
- H2-8 Next to the ventilation fan motor.
- G2 Grounding point, battery tray, on the left-hand wheel housing.

Components

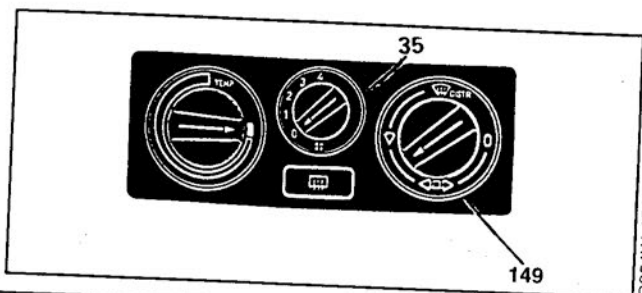
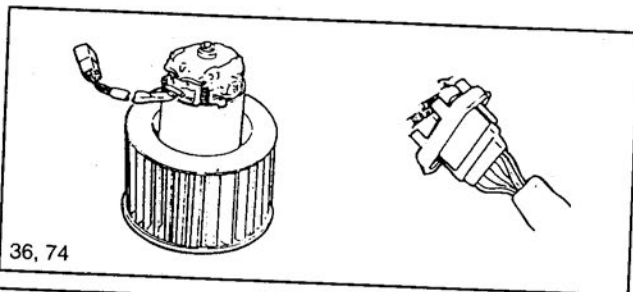
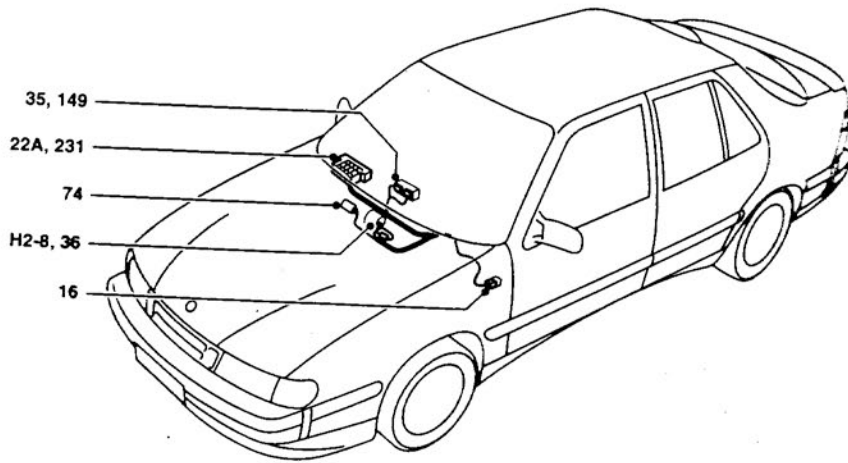

Electrically heated front seats

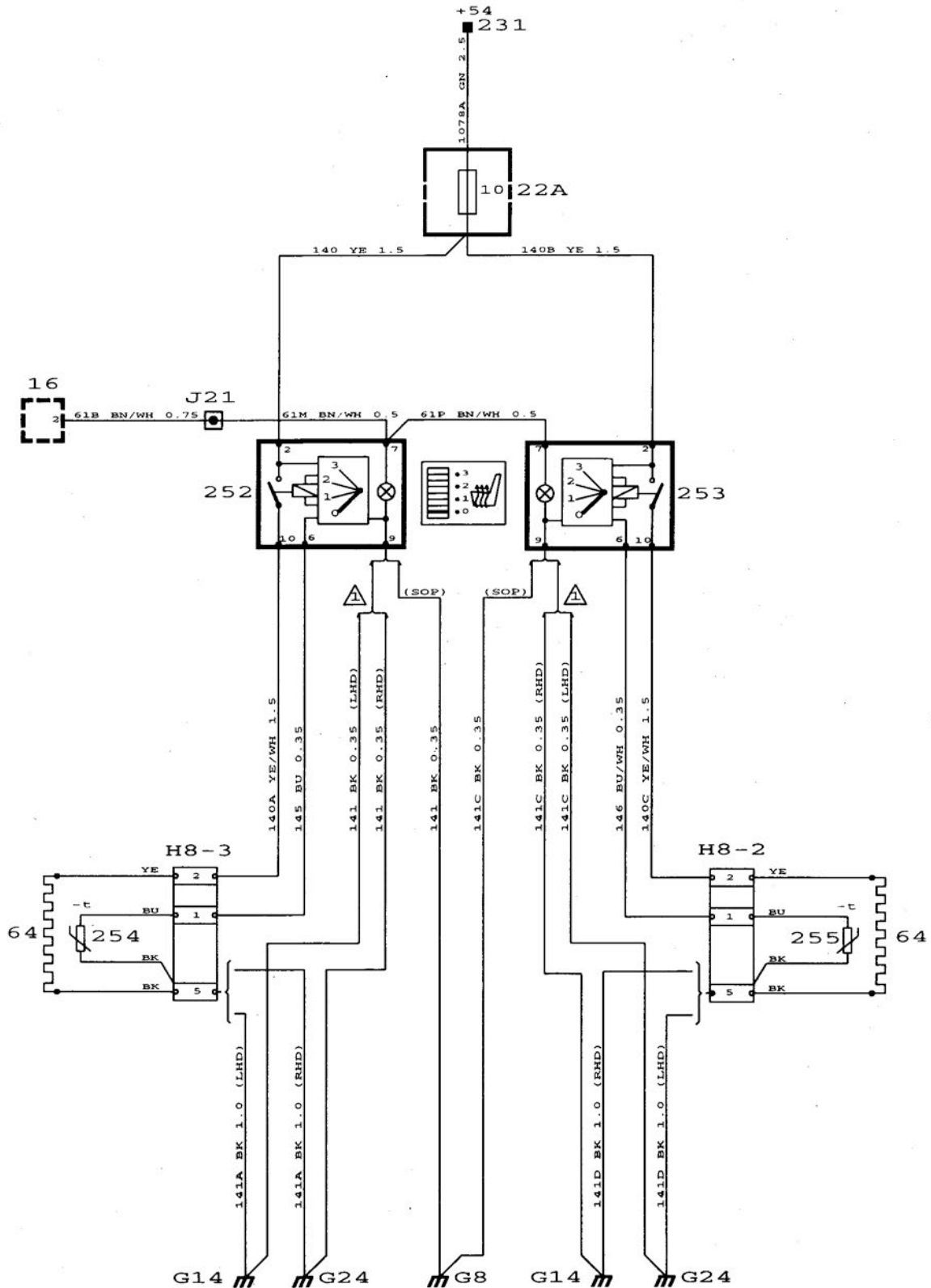

Description of operation

Both front seats are equipped with rheostat-controlled electric heating.

Heating pads 64 are supplied with current via fuse 10 and switched on and off by temperature sensor 254 in the driver's seat and 255 in the front passenger's seat. The temperature sensors consist of an NTC resistor whose resistance varies with the temperature of the heating pad.

The temperature of the front seat heating pads can be adjusted by means of rheostats 252 and 253. These have four positions: 0-1-2-3. In position 0 the heating is not activated while position 3 gives maximum heating. When the heating pads reach the preset temperature for each position, they are switched off and switched back on when their temperature drops to the lower limit for each rheostat setting.

Fault diagnosis hints

- 1 Turn the ignition switch to the Drive position.
- 2 Check that fuse 10 is intact and that current is supplied to rheostats 252 and 253.
- 3 Check that there is no open circuit in temperature sensors 254 and 255.
- 4 Test the heating elements in the heating pads and check that no open circuit has occurred.
- 5 Check the connectors, wiring harness and ground connections.

Component locations

- 16 Rheostat, lighting for controls, on dashboard between the steering wheel and driver's door.
 - 22A Fuse board behind the cover flap in the glove box.
 - 64 Heating pads in seat cushion and backrest on driver and passenger seats.
 - 231 Distribution terminal (+54 circuit) in main fuse box behind the glove box.
 - 252 Rheostat for driver's seat heating pad, on dashboard between the steering wheel and centre console.
 - 253 Rheostat for front passenger seat heating pad, on dashboard between the steering wheel and centre console.
 - 254 Temperature sensor for driver's seat heating pad, in the driver's seat.
 - 255 Temperature sensor for front passenger seat heating pad, in the passenger's seat.
- 8-pin connectors*
- H8-2 Under the right-hand seat.
 - H8-3 Under the left-hand seat.
 - G8 Grounding point, on the stiffening member under the left-hand loudspeaker grille.
 - G14 Grounding point, left-hand front seat member.
 - G24 Grounding point, right-hand front seat member.

Components

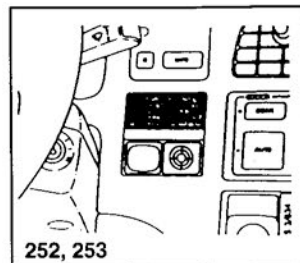
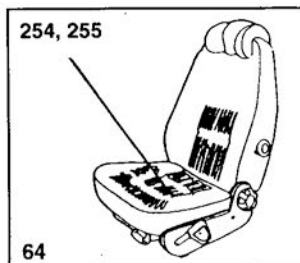
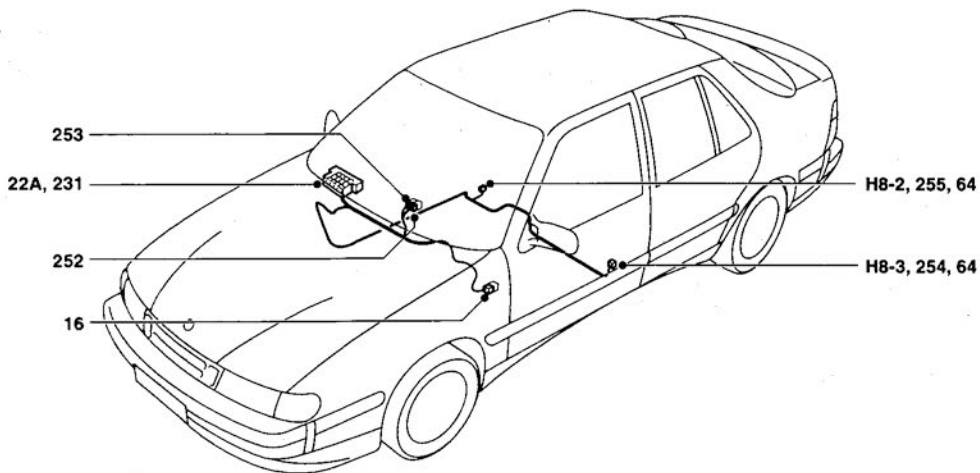

C366W-4550

Electrically heated rear window and door mirrors

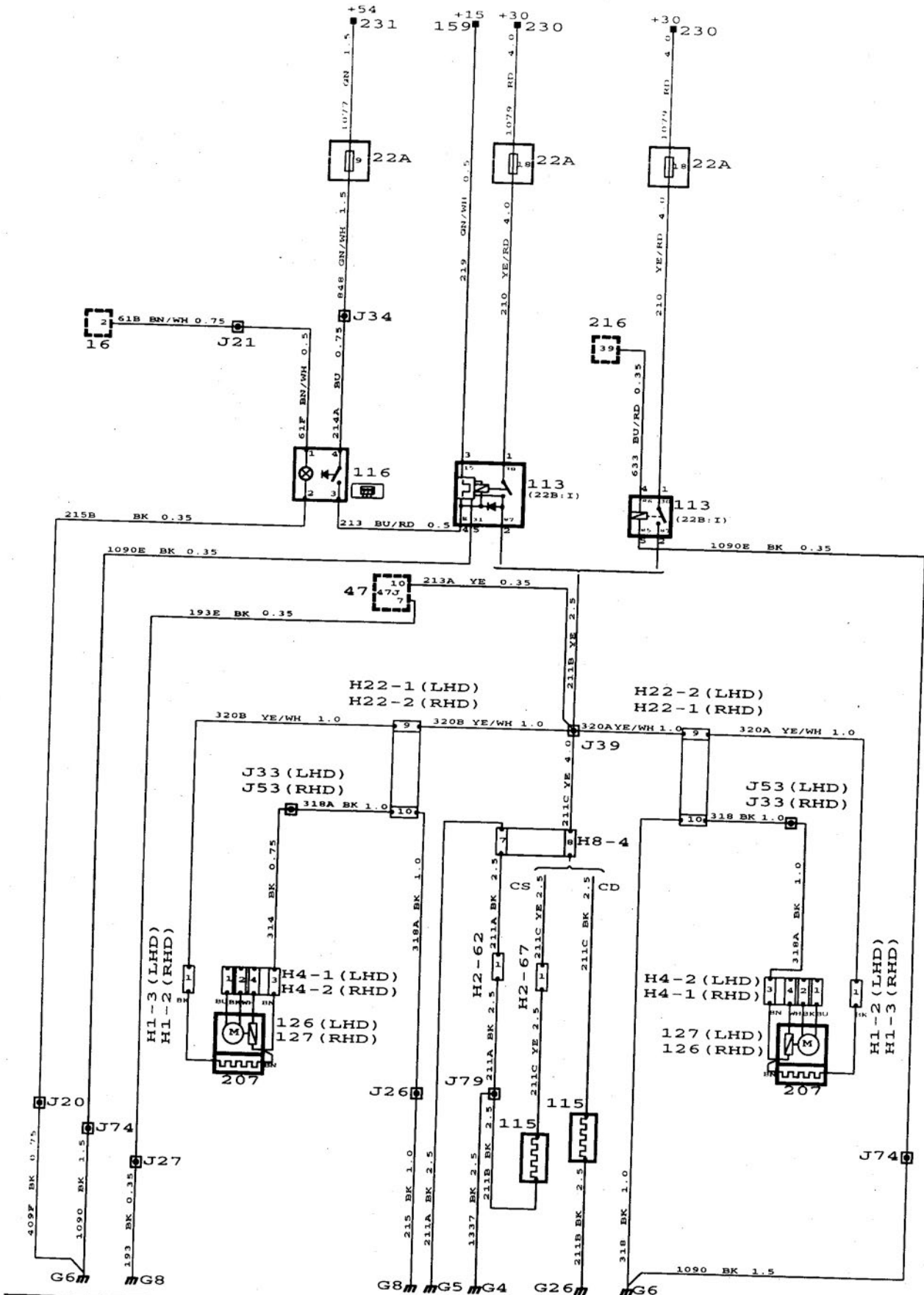

Description of operation

The electrically heated rear window and electrically heated door mirrors are switched on and off with a switch on the heating panel. In cars with ACC automatic climate control, activation is via the ACC unit. When the electrically heated rear window is activated, elements 207 in electrically heated door mirrors 126 and 127 are also supplied with current.

Current is supplied via fuse 18 to terminal 30 on time-delay relay 113. When the ignition switch is in the Drive position, current is also supplied via fuse 13 to terminal 15 on time-delay relay 113 and via fuse 9 to spring-loaded switch 116.

Instead of time-delay relay 113, cars with ACC are fitted with an ordinary relay which is controlled by the ACC unit.

When the switch is depressed, supply voltage is fed to relay terminal E, causing the relay to operate. Current from relay terminal 87 flows to electrically heated rear window 115, the electrically heated door mirrors and indicator lamp 47J and then to ground. The relay has a time delay function which maintains the connection for about 10 minutes, after which the circuit is broken.

If the ignition switch is turned to the Lock position while the electrically heated rear window is switched on, the circuit supplying current to the relay will be broken and the relay then breaks the supply of current to the electrically heated rear window, the pilot lamp and the electrically heated door mirrors.

Fault diagnosis hints

The electrically heated rear window and door mirrors are activated by turning the ignition switch to the Drive position.

- 1 Check that fuses 9 and 18 are intact and supplied with current.
- 2 Check the voltage on relay 113.
- 3 Check the voltage on relay 113 while switch 116 is activated.
- 4 Activate relay 113 and check the electrically heated rear window connections and that the window heating element is supplied with current.
- 5 Check the connectors, wiring harness and ground connections.

If there is an open circuit in the diode on relay 113, the relay holding circuit will not operate.

Component locations

16	Rheostat, lighting for controls, on dashboard between the steering wheel and driver's door.	H1-2	<i>1-pin connectors</i> In the right-hand front door below the door mirror.
22A	Fuse board behind the cover flap in the glove box.	H1-3	In the left-hand front door below the door mirror.
47J	Indicator lamp, electrically heated rear window, in the main instrument display panel.	H2-62	<i>2-pin connectors</i> In the tailgate on the left.
113	Relay, electrically heated rear window, in the main fuse box behind the glove box.	H2-67	In the tailgate on the right-hand side.
115	Electrically heated rear window.	H4-1	<i>4-pin connectors</i> In the driver's door below the door mirror.
116	Switch, electrically heated rear window, on control panel for heating and ventilation.	H4-2	In the passenger's door below the door mirror.
126	Motor, electrically adjustable door mirror, driver's side, in door mirror.		<i>8-pin connector</i>
127	Motor, electrically adjustable door mirror, passenger's side, in door mirror.	H8-4	By the left-hand rear wheel housing.
159	Distribution terminal (+15 circuit) in main fuse box behind the glove box.	H22-1	<i>22-pin connectors</i> Behind the cable entry in the left-hand A pillar.
207	Heating element in door mirrors.	H22-2	Behind the cable entry in the right-hand A pillar.
216	ACC control module, in the centre of the dashboard.	G4	Grounding point, in the tailgate, CS.
230	Distribution terminal (+30 circuit) in main fuse box behind the glove box.	G5	Grounding point, under the rear seat on the left.
231	Distribution terminal (+54 circuit) in main fuse box behind the glove box.	G6	Grounding point, negative distribution terminal, in main fuse box 22B behind the glove box.
		G8	Grounding point, dashboard, by the left-hand front loudspeaker socket.
		G26	Grounding point, right-hand C pillar (4D).

Components

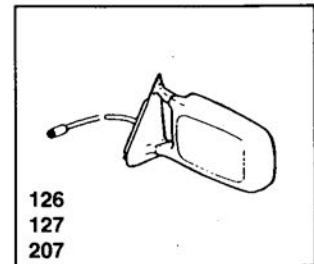
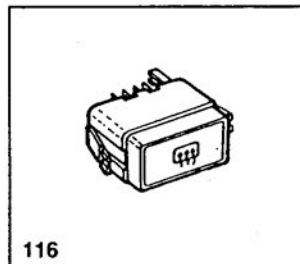
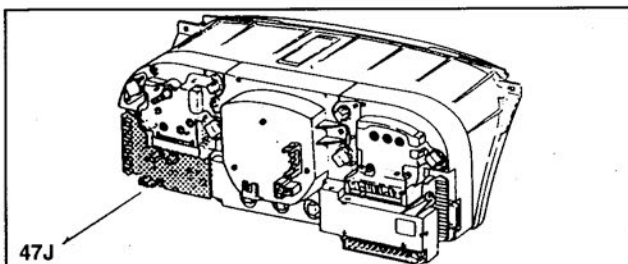
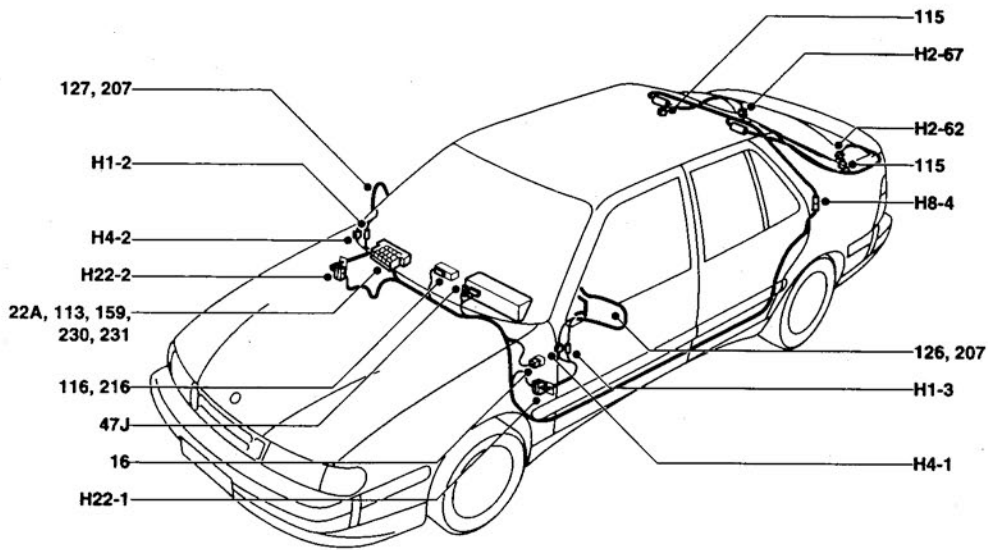

C366W-4551

Electrically adjustable front seat

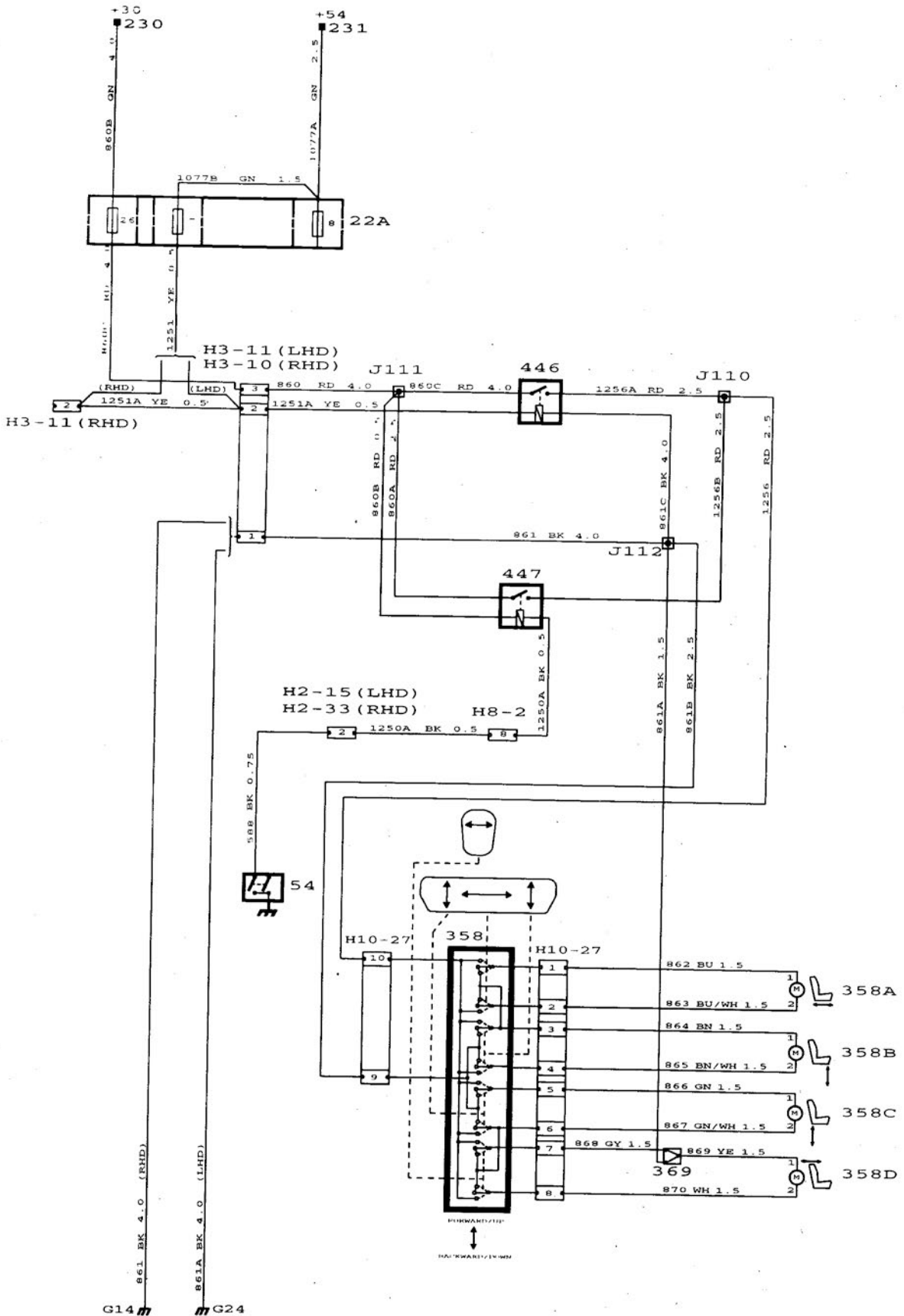

Description of operation

The passenger seat can be adjusted using the switch on the outside of the seat. Electric motors move the seat lengthwise, change the height of the seat cushion at the front and rear and change the angle of the backrest.

When the ignition switch is in the Drive position, current is supplied via fuse 26 to switch 358 in the passenger seat.

The following electric motors can be controlled from switch 358 in the left-hand seat:

- Electric motor 358A moves the seat forwards and rearwards.
- Electric motor 358B raises or lowers the front of the seat.
- Electric motor 358C raises or lowers the rear of the seat.
- Electric motor 358D changes the angle of the seat backrest. The seat backrest can be reclined until it rests against the rear seat cushion. Forward movement is limited by microswitch 369.

Relay 446, which is controlled by the door switches, makes it possible to adjust the seat even when the ignition switch is in the OFF position.

Fault diagnosis hints

The seat can be electrically adjusted with the ignition switch in the OFF position.

- 1 Check that fuse 26 is intact and that the fuses are supplied with current.
- 2 Check that current is supplied to switch 358.
- 3 Check that current is supplied to the motors by activating the corresponding switches.
- 4 Check the connectors, wiring harness and ground connections.

See Service Manual **8:2 Interior equipment** for further details of checking and fault diagnosis.

Component locations

22A	Fuse board behind the cover flap in the glove box.
54	Door switches in the door pillars.
230	Distribution terminal (+30 circuit) in the main fuse box behind the glove box.
231	Distribution terminal (+54 circuit) in main fuse box behind the glove box.
358	Switch, electrically adjustable passenger seat, on the outside of the seat.
358A-D	Electric motors, passenger seat, under the seat.
369	Microswitch, seat backrest, between the seat cushion and backrest beside the inner edge of each seat.
446	Relay for electrically adjustable front seat via the ignition switch, under the seat.
447	Relay for electrically adjustable front seat via the door switch, under the seat.
	<i>2-pin connectors</i>
H2-15	In the right-hand A pillar.
H2-33	In the left-hand A pillar.
	<i>3-pin connectors</i>
H3-10	Under the left-hand seat, to the left on the electronics console.
H3-11	Under the right-hand seat, to the right on the electronics console.
	<i>8-pin connector</i>
H8-2	Under the passenger seat.
G14	Grounding point, left-hand front seat member
G24	Grounding point, right-hand front seat member.

Components

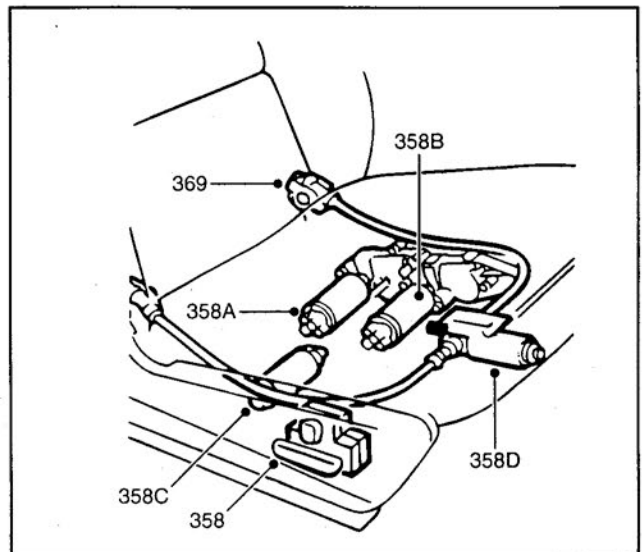
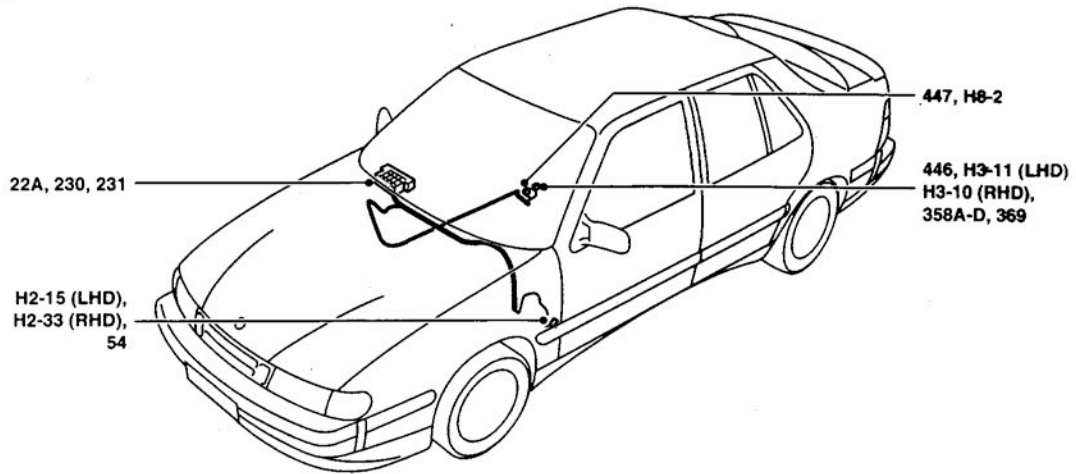

C862W-4552

Electrically adjustable front seat with memory

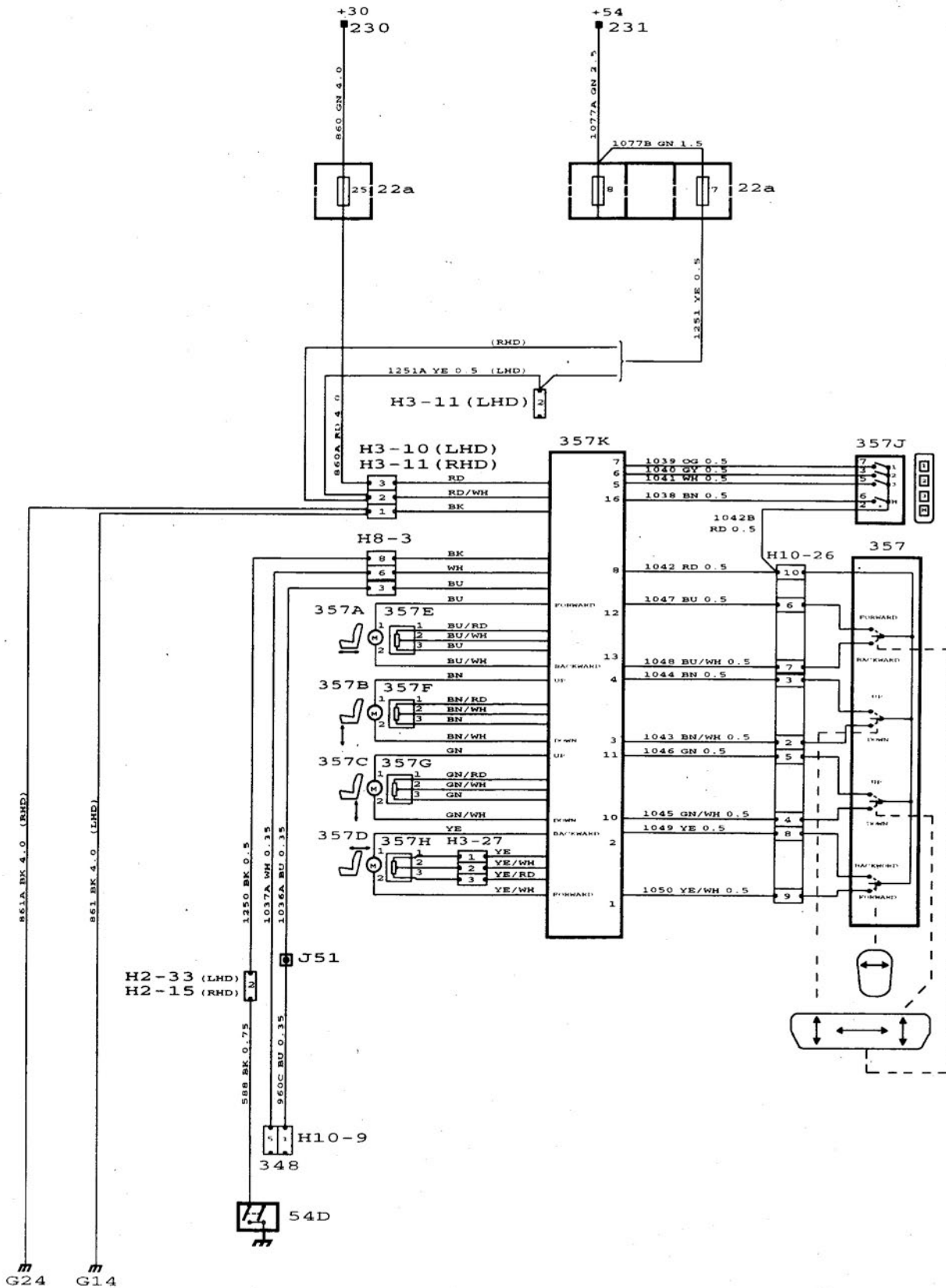

Description of operation

The electrically adjustable front seat with memory is only fitted in the driver's position and consists of:

- Two switches, one for manual seat adjustment and one for storing the settings and recalling them from the memory.
- Electronic control module
- Four electric motors with position sensors.

Switches

The switch unit consists of a number of switches, one pole of which is supplied with battery positive voltage from pin 8 on the electronic unit. When a switch is activated, battery positive voltage is routed to the corresponding switch input on the electronic unit.

Electronic unit

Current (+30 circuit) is supplied via fuse 25 to the electronic unit which in its turn supplies this current to motors, potentiometers and switches.

The electronic unit continuously monitors the switches and if a valid combination of switches is activated, it carries out the corresponding operation.

When a motor is running, the electronic unit monitors current consumption and the position of the seat via the position sensors (potentiometers).

The electronic control unit's memory can store three different seat positions and five diagnostic trouble codes. The memory stores the information even if voltage is lost.

Motors

The motors are supplied with current via the electronic unit. The supply is battery positive voltage and its polarity changes with direction.

Position sensors

The position sensors consist of potentiometers which are mounted on each motor shaft.

The potentiometers are supplied via the electronic unit with about 5 V on pins 1 and 3. When the motor shaft rotates, the voltage of the potentiometer's centre output, pin 2, varies between 0.4 V and 4.6 V. By measuring this voltage, the electronic unit can ascertain the position of the seat.

Manual adjustment of the seat setting

Only two motors can be run at the same time. If an attempt is made to operate more than two switches, all the motors will stop.

The forward/rearward movement of the seat and the angle of the seat cushion are limited by mechanical stops. The electronic unit therefore supplies current to these motors as long as each switch in the manual control is activated (up to a maximum of 1 minute).

The backrest has no mechanical stop to limit its forward and rearward inclination. The limit is set by the electronic unit on the basis of signals from the backrest position sensor. For this reason, the electronic unit does not allow operation of the backrest motor if the position sensor is faulty.

Using the memory

- Adjust the seat to the desired position by means of manual adjustment switch 357.
- Press the memory store button marked M in memory switch panel 357J and hold it depressed.
- Press and release one of the memory buttons marked 1-3. The electronic unit now reads all positions and stores them in the memory. Release the button marked M.

If there is a fault in the position sensors, no new seat setting will be stored in the memory, but earlier settings are retained.

- When using the memory unit to adjust the seat, press one of the memory buttons 1-3 and hold it depressed.

The electronic unit reads all position sensors and controls the motors until the seat setting corresponds to the setting stored in the memory, or until the memory button is released.

Fault diagnosis hints

Faults detected by the electronic unit are stored in the memory as diagnostic trouble codes. These are read using the ISAT scan tool.

If the electronic control module detects a fault in any of the components or if a motor is moving too slowly, this component or motor is stopped.

The ISAT scan tool can also be used to read the position of each individual switch and the value of all position sensors. This is described in greater detail in Service Manual **8:2 Interior equipment**.

Component locations

22A	Fuse board behind the cover flap in the glove box.
54	Door switches in the door pillars.
230	Distribution terminal (+30 circuit) in main fuse box behind the glove box.
231	Distribution terminal (+54 circuit) in main fuse box behind the glove box.
348 (H10-9)	Scan tool diagnostics data link connector under the right-hand seat.
357	Switch, electrically adjustable driver's seat, on the outside of the seat.
357A-D	Electric motors, driver's seat, under the seat.
357E-H	Position sensor, electrically adjustable driver's seat, memory, under the seat on the corresponding motor shaft.
357J	Switch, memory, on the outside of the driver's seat.
357K	Electronic control module, electrically adjustable driver's seat with memory, under the seat.
	<i>2-pin connectors</i>
H2-15	In the right-hand A pillar.
H2-33	In the left-hand A pillar.
	<i>3-pin connectors</i>
H3-10	Under the left-hand seat, to the left on the electronics console.
H3-11	Under the right-hand seat, to the right on the electronics console.
	<i>8-pin connectors</i>
H8-2	Under the right-hand seat.
H8-3	Under the left-hand seat.
G14	Grounding point, left-hand front seat member
G24	Grounding point, right-hand front seat member.

Components

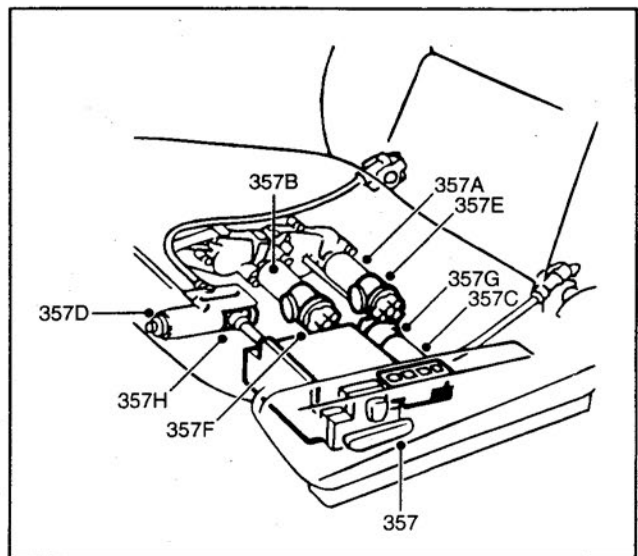
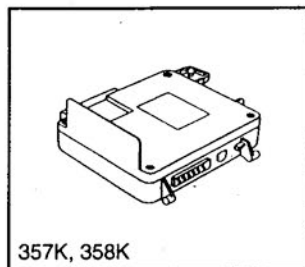
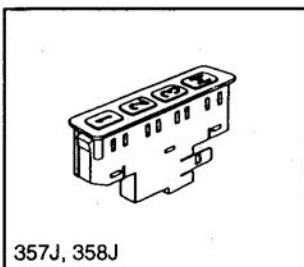
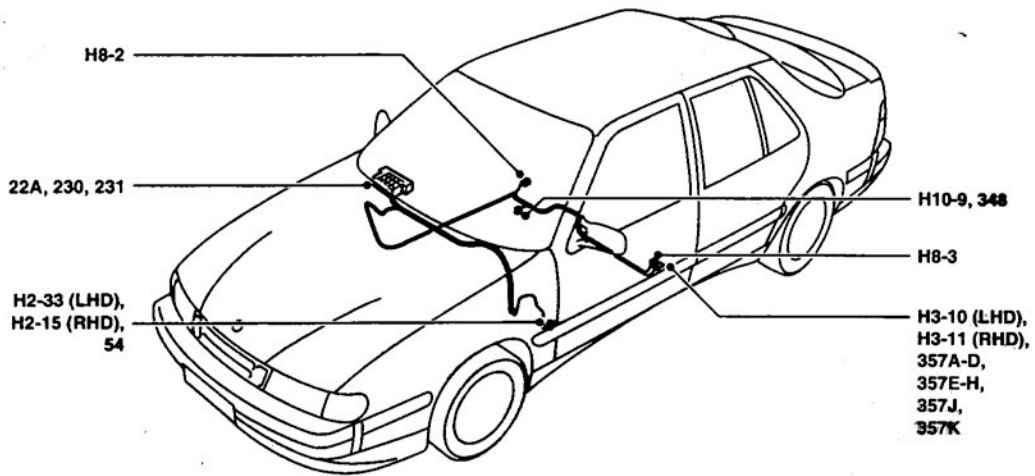

C852W-4553

Electric window lifts LHD

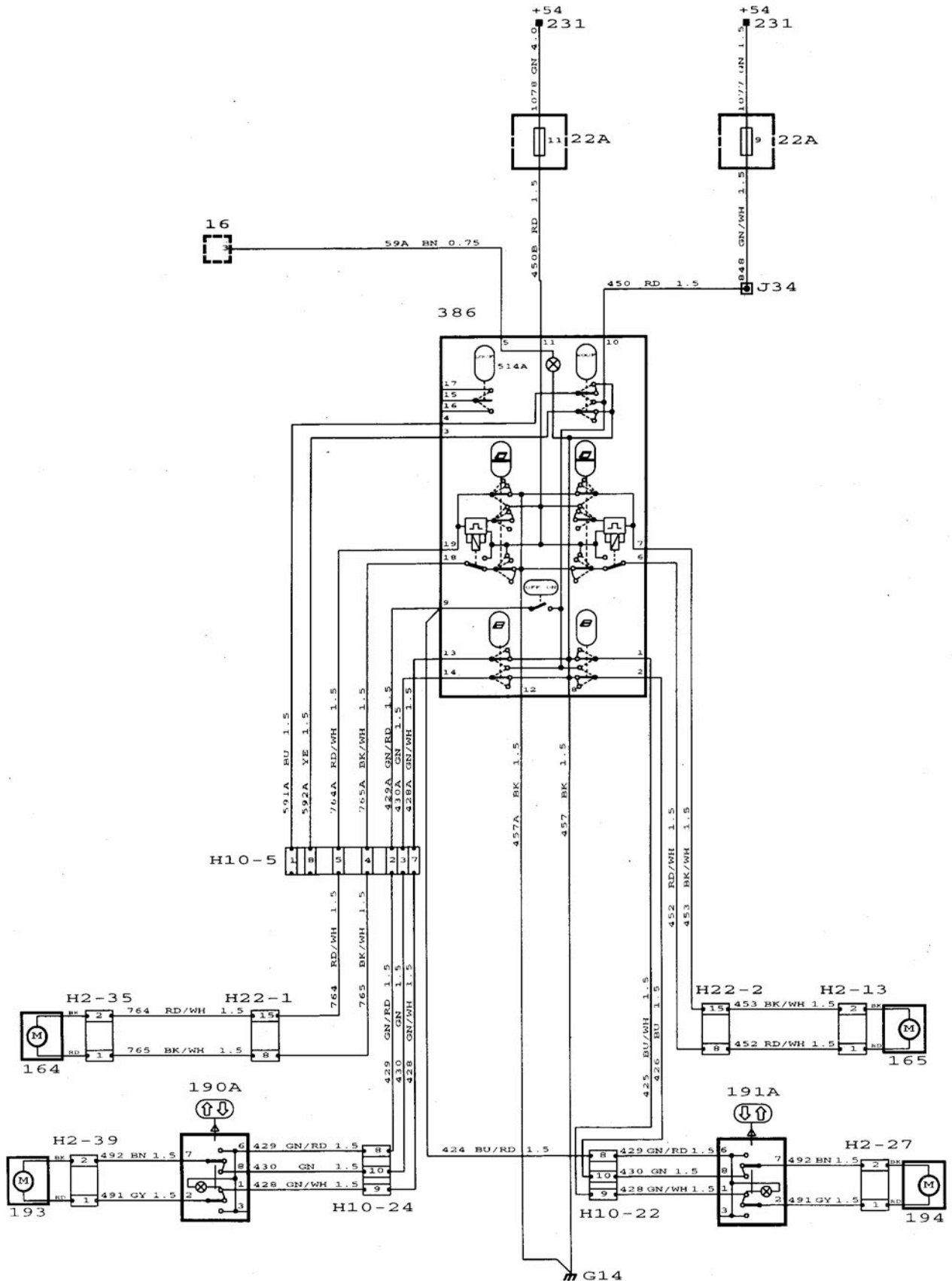

Electric window lifts RHD

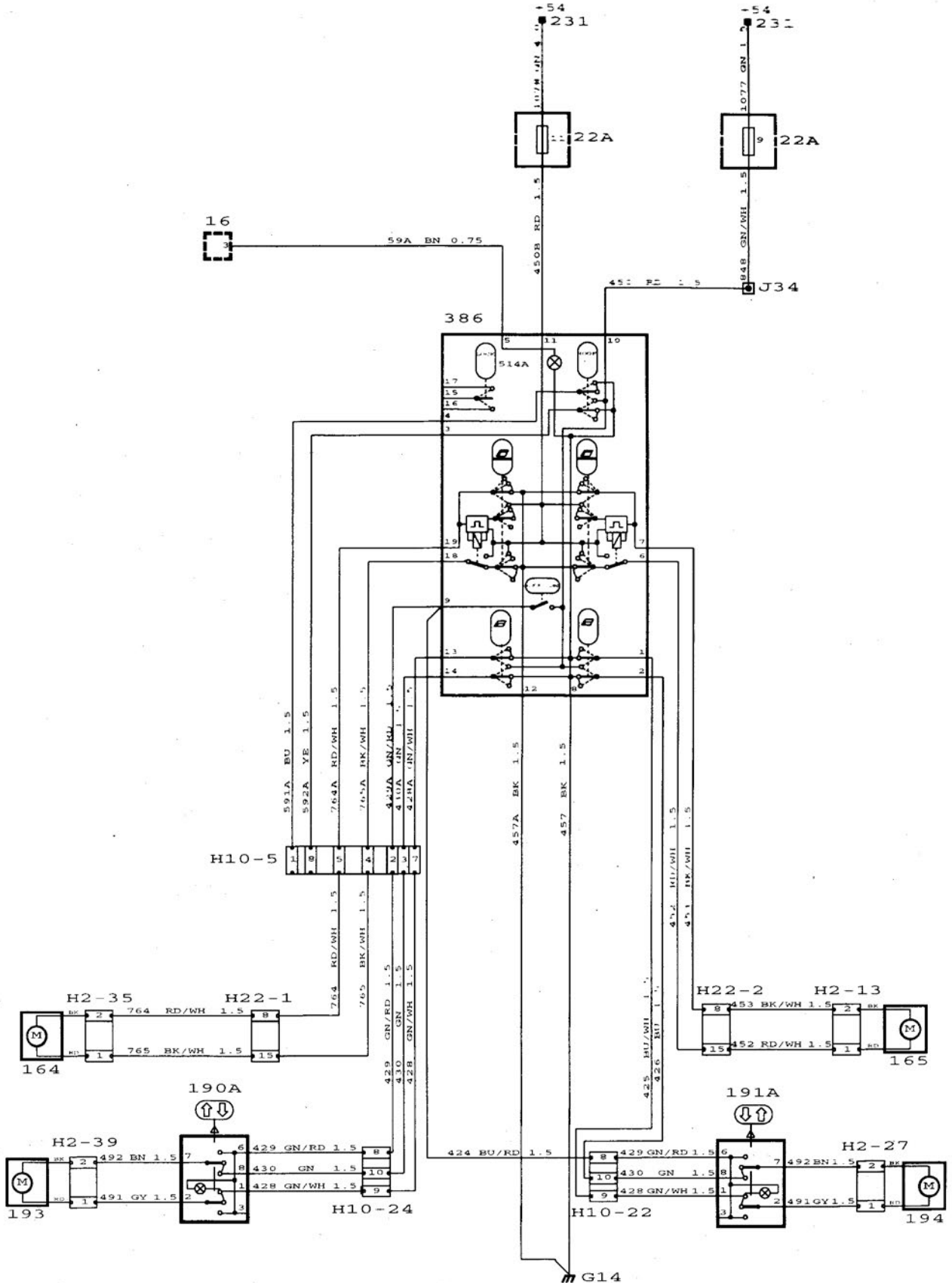

Description of operation

All electric window lifts in the car can be operated using a switch on the centre console between the front seats. The window lifts in the rear doors can also **under certain circumstances** be operated using the switches in each door.

- Switch 386 for operating the window lifts in the front doors is supplied with current via fuse 11.
- Current is supplied via fuse 9 to switch 386 for operating the window lifts in the rear doors.
- If the **ON/OFF** switch is closed (ON), the window lifts in the rear doors can also be operated from switch 190A in the left-hand rear door and switch 191A in the right-hand rear door.
- If the **ON/OFF** switch is open (OFF), the switches on the rear doors will be inoperative. The window lifts in the rear doors can then be controlled only by means of switch 386 on the centre console.
- Pressing the "window" symbol on one of the switches lowers the window. Pressing the part of the switch with no symbol rolls the window up.

Automatic window lift control

The switches in the front doors are different to the other switches in that they have two positions to lower the window and one position to roll up the window.

DOWN Position 1: The window descends as long as the switch is held in this position. Positive current is supplied to motor 164 via pin 18 or to motor 165 via pin 6 on the switch.

DOWN Position 2: The window goes all the way down, even if the switches are released after a moment. The coil in the relays, integrated into the switch, is supplied with positive current and the relays operate. Due to a time-delay function in the relays, the supply of current is maintained until the window is completely open, even if the switch is released immediately. This function is cancelled by moving the switch to position 3.

UP: The window goes up as long as the switch is held in this position. Positive current is supplied to motor 164 via pin 19 or to motor 165 via pin 7 of the switch.

Fault diagnosis hints

The electric window lifts can be operated when the ignition switch is in the Drive position.

A TIP

To avoid damaging the centre console, and to remove switch 386 from the centre console in the easiest possible way when taking readings, proceed as follows:

- Where the cover part, the centre console and the carpet meet, there is a flap. If this is lifted slightly, a hand can be introduced under it to press out the switch from behind.

- 1 Check that fuses 9 and 11 are intact and supplied with current.
- 2 Check that current is supplied to pins 10 and 11 of switch 386.
- 3 Check that pins 18, 6, 14 and 2 are supplied with current when the windows are lowered.
- 4 Check that pins 19, 7, 13 and 1 are supplied with current when the windows are raised.
- 5 If the window lifts in the rear doors cannot be operated from the switches on the doors, check that current is supplied to pin 9 of the **ON/OFF** switch.
- 6 Check the operation of the switches on the rear doors by taking instrument readings on their electrical connections.
- 7 Check the connectors, wiring harness and ground connections.

Component locations

16	Rheostat, lighting for controls, on dashboard between the steering wheel and driver's door.
22A	Fuse board behind the cover flap in the glove box.
164	Motor, left-hand electric window lift, in the left-hand front door.
165	Motor, right-hand electric window lift, in the right-hand front door.
190A	Switch, left-hand rear door electric window lift, in the left-hand rear door.
191A	Switch, right-hand rear door electric window lift, in the right-hand rear door.
193	Motor, left-hand rear door electric window lift, in the left-hand rear door.
194	Motor, right-hand rear door electric window lift, in the right-hand rear door.
231	Distribution terminal (+54 circuit) in main fuse box behind the glove box.
386	Switch, electric window lifts, on the centre console between the front seats.
514A	Switch, simultaneous operation of central locking in 386.
	<i>2-pin connectors</i>
H2-13	In the right-hand front door, beside the window lift.
H2-27	In the right-hand rear door, beside the window lift.
H2-35	In the left-hand front door, beside the locking mechanism.
H2-39	In the left-hand rear door, beside the locking mechanism.
	<i>10-pin connectors</i>
H10-5	Under the left-hand seat.
H10-22	In right-hand B pillar.
H10-24	In left-hand B pillar.
	<i>22-pin connectors</i>
H22-1	Behind the cable entry in the left-hand A pillar.
H22-2	Behind the cable entry in the right-hand A pillar.
G14	Grounding point, left-hand front seat member

Components

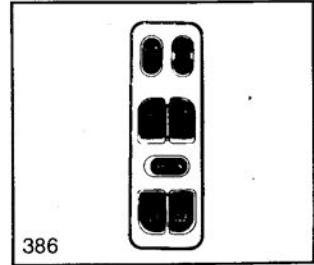
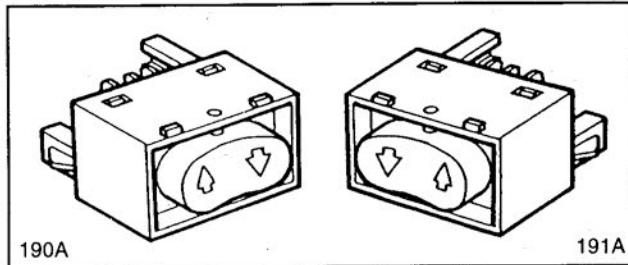
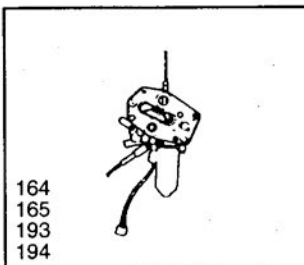
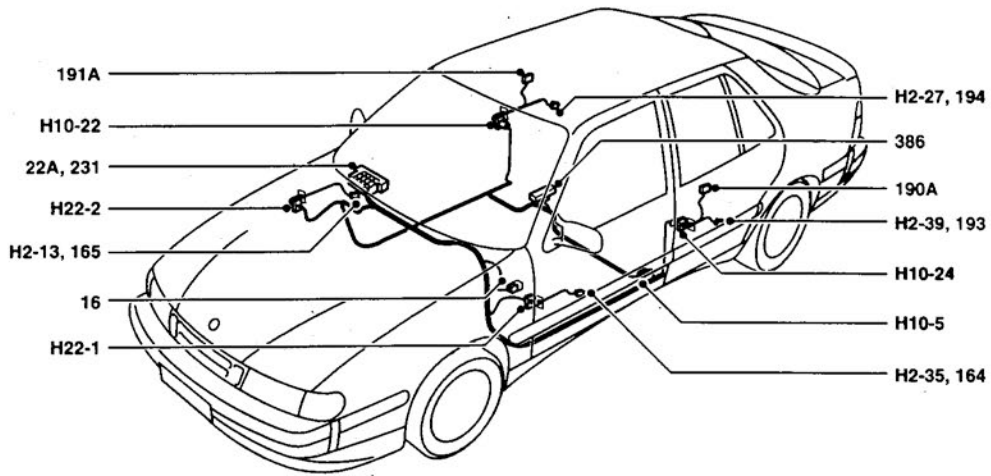

Electrically operated sunroof

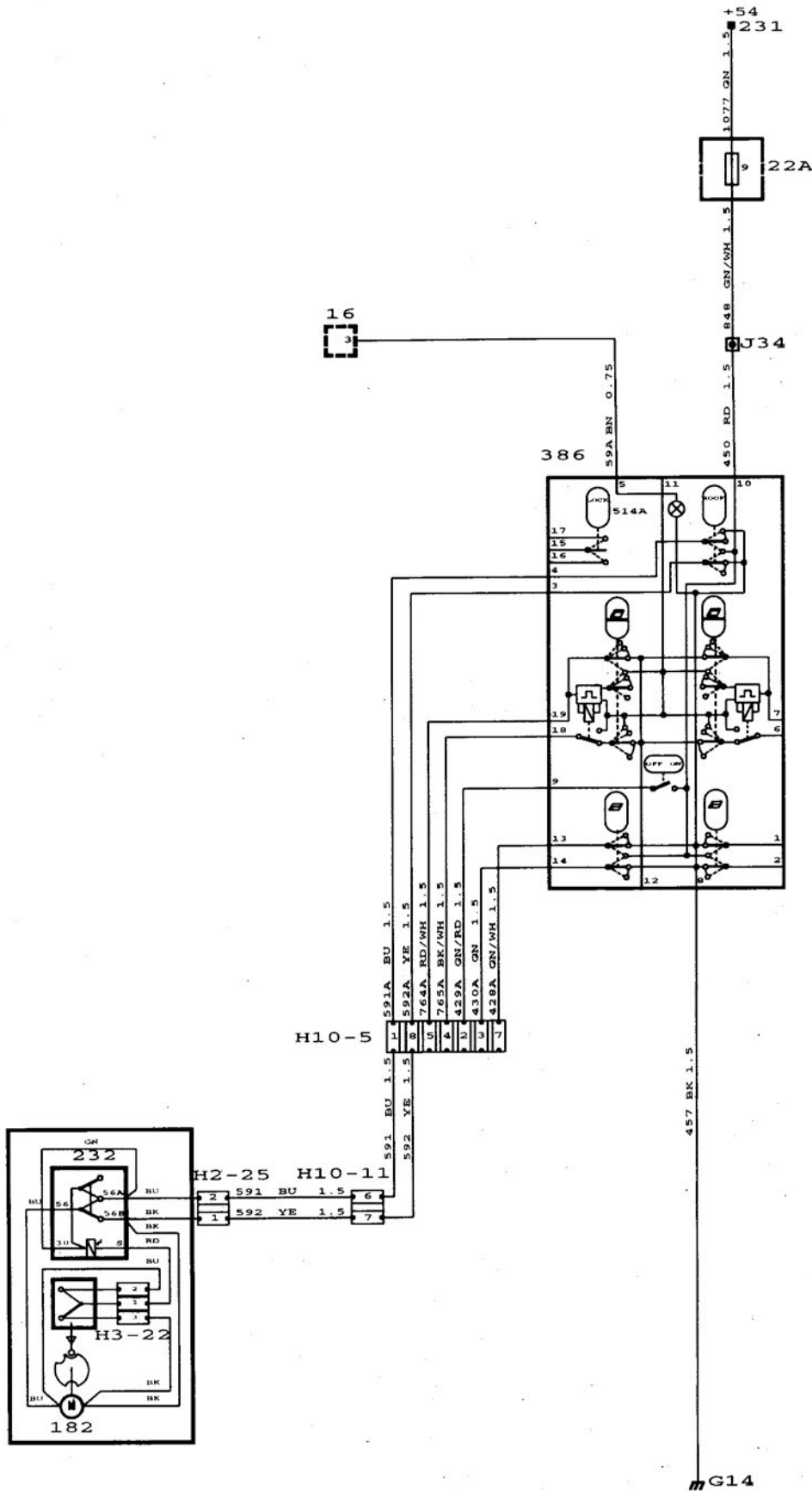

Description of operation

The sunroof is operated by means of a two-position switch, and can be opened in two ways:

- The sunroof can be opened fully or partially by running it rearwards.
- The rear of the sunroof can be raised.

The sunroof is supplied with current via fuse 9 which supplies switch 386 (ROOF) with current.

Opening the sunroof

The sunroof is opened rearwards by pressing switch 386 (ROOF) so that current is supplied from terminal 3 to terminal BK of motor 182.

Current is then supplied to a microswitch, which is controlled by motor 182's cam, to the actuating coil of stepping relay 232, and back to ground via terminal 4 of switch 386 (ROOF).

When the relay operates, the motor's other terminal BU is grounded. The motor moves the sunroof rearwards. At the same time, the cam actuates the microswitch so that the supply of current to the stepping relay's coil is broken but the relay's contacts remain closed so that the motor is grounded as long as the switch is held depressed.

If the switch is held depressed until the sunroof is completely open, the microswitch is returned to the rest position. The coil in the relay once again receives current and the relay contacts return to their original position. The ground connection is broken and the motor stops.

The motor is equipped with an overload cut-out which trips if the sunroof is for some reason prevented from moving.

Closing the sunroof

The sunroof is closed by pressing switch 386 (ROOF). This causes current to be supplied via terminal 4 to terminal BU of the motor.

Motor terminal BK is grounded via the switch.

The motor moves the sunroof forwards. At the same time the cam actuates the microswitch so the connection of the stepping relay's coil to ground is broken but the relay's contacts remain closed so that the motor continues to be supplied with positive current as long as the switch is held depressed.

If the switch is held depressed until the sunroof is completely closed, the cam actuates the microswitch so that it returns to its rest position. The coil in the relay is grounded and the relay contact breaks the supply of current so that the motor stops.

Raising and lowering the rear of the sunroof

Before the rear of the sunroof can be raised, the sunroof must be completely closed.

When switch 386 (ROOF) is pressed to the **closing** position, the rear of the sunroof lifts. The function is the same as when closing the sunroof when it moves forward.

When the rear of the sunroof is raised, it can be lowered by moving the switch to the **opening** position. The function is the same as when opening the sunroof when it moves rearward.

Fault diagnosis hints

The sunroof is activated by turning the ignition switch to the Drive position:

- 1 Check that fuse 9 is intact and supplied with current.

A TIP

To avoid damaging the centre console, and to remove switch 386 from the centre console in the easiest possible way when taking readings, proceed as follows:

- Where the cover part, the centre console and the carpet meet, there is a flap. If this is lifted slightly, a hand can be introduced under it to press out the switch from behind.
-
- 2 Check that current is supplied to switch 386, terminal 10.
 - 3 Check that current is supplied from terminal 3 or 4 of switch 386 to stepping relay 232, motor 182 and the microswitch by moving the switch to different positions.
 - 4 Check the connectors, wiring harness and ground connections.

Component locations

- 16 Rheostat, lighting for controls, on dashboard between the steering wheel and driver's door.
- 22A Fuse board behind the cover flap in the glove box.
- 182 Motor, electrically operated sunroof, in the front part of the roof.
- 231 Distribution terminal (+54 circuit) in main fuse box behind the glove box.
- 232 Stepping relay, electrically operated sunroof, in the front part of the roof beside the sunroof motor.
- 386 Switch, electric window lifts and sunroof, on the centre console between the front seats.
- 514A Switch, simultaneous closing of central locking, in 386.
2-pin connector
- H2-25 In the front part of the roof, adjacent to the sunroof motor.
3-pin connector
- H3-22 In the front part of the roof beside the sunroof motor.
10-pin connectors
- H10-5 Under the left-hand seat (green).
- H10-11 On the far left under the dashboard, behind the knee shield.
- G14 Grounding point, left-hand front seat member.

Components

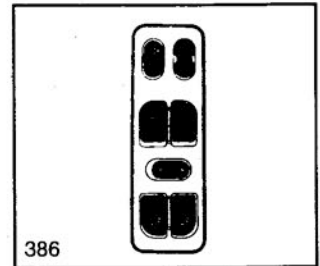
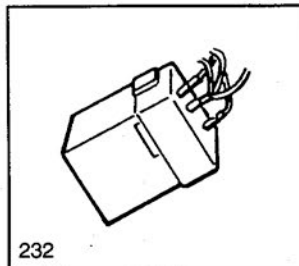
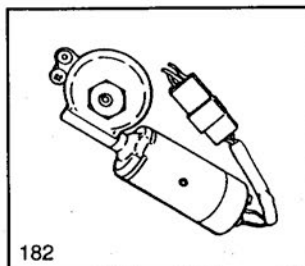
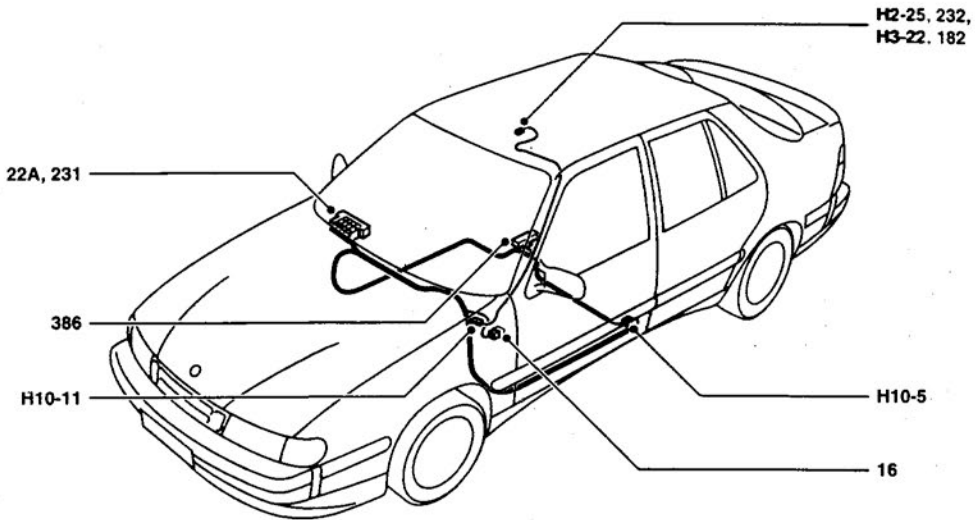

C812W-4555

Electrically adjustable and heated door mirrors LHD

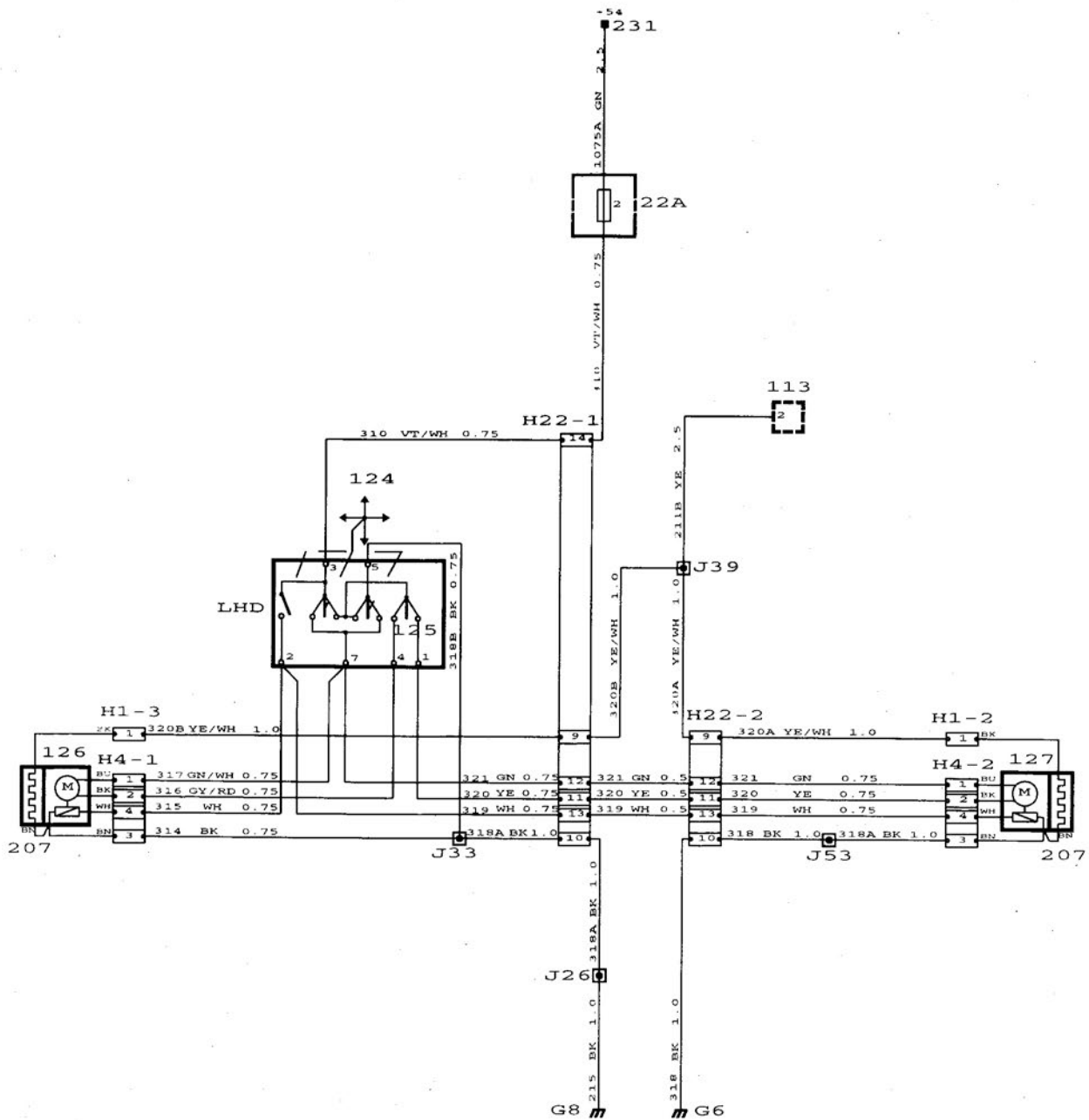

Electrically adjustable and heated door mirrors RHD

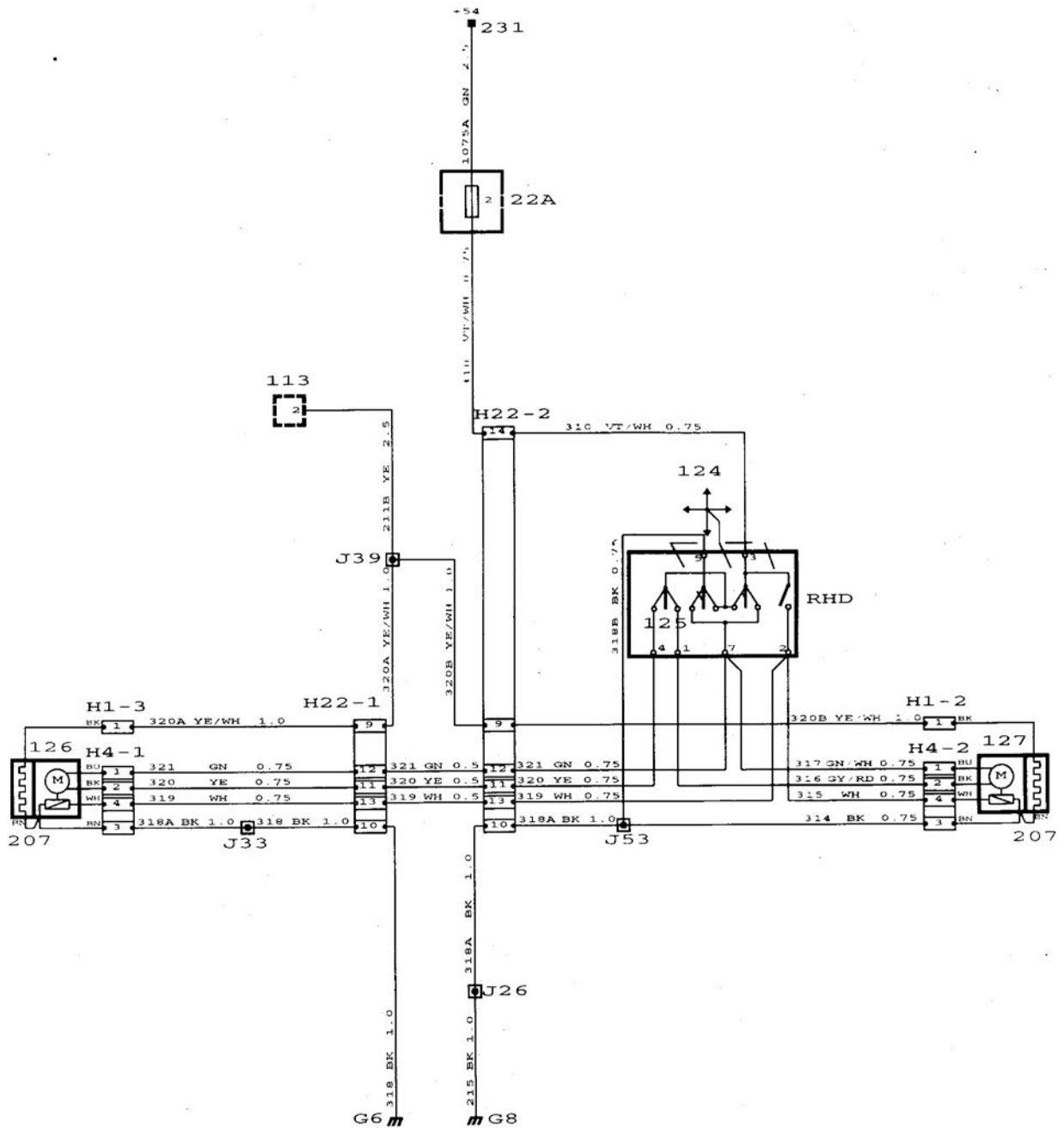

Description of operation

The door mirrors are operated with a four-position switch and a selector on the driver's door.

Heating for the door mirrors is turned on with the switch for the electrically heated rear window.

Current is supplied from fuse 2 to terminal 3 on operating switch 124 which has four positions. Using selector 125, you can choose which of the two door mirrors, left or right, is to be adjusted with switch 124.

Check in the table below that the switch connections are supplied with current and grounded in each position:

Position	Left-hand door mirror		Right-hand door mirror	
	+	—	+	—
↑	2,3,4	5,7	1,2,3	5,7
↓	2,3,7	4,5	2,3,7	1,5
←	3,4	5,7	1,3	5,7
→	3,7	4,5	3,7	1,5

Electrically heated door mirrors 207, see sections entitled **Electrically heated rear window and electrically heated rear-view mirrors** on page 285.

Fault diagnosis hints

The door mirrors will be operative when the ignition switch is in the Drive position.

- 1 Check that fuse 2 is intact and supplied with current.
- 2 Check the voltage on terminal 3 of switch 124.
- 3 Check that current is supplied to motors 126 and 127 by activating the switches.
- 4 Check the connectors, wiring harness and ground connections.

Component locations

22A	Fuse board behind the cover flap in the glove box.
113	Time-delay relay, electrically heated rear window, in the main fuse box behind the glove box.
124	Switch, electrically adjustable door mirror, on the driver's door.
125	Switch, electrically adjustable door mirror left/right selection, on the driver's door.
126	Motor, left-hand electrically adjustable door mirror, in the left-hand front door.
127	Motor, right-hand electrically adjustable door mirror, in the right-hand front door.
207	Heating element in door mirrors.
231	Distribution terminal (+54 circuit) in main fuse box behind the glove box.
	<i>1-pin connectors</i>
H1-2	In the right-hand front door below the door mirror.
H1-3	In the left-hand front door below the door mirror.
	<i>4-pin connectors</i>
H4-1	In the left-hand front door below the door mirror.
H4-2	In the right-hand front door below the door mirror.
	<i>22-pin connectors</i>
H22-1	Behind the cable entry in the left-hand A pillar.
H22-2	Behind the cable entry in the right-hand A pillar.
G6	Grounding point, negative distribution terminal, in main fuse box 22B behind the glove box.
G8	Grounding point, dashboard, beside the front left-hand loudspeaker socket.

Components

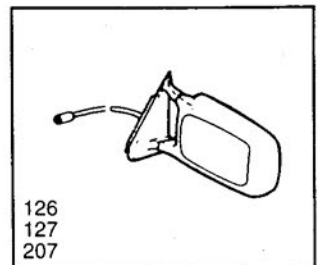
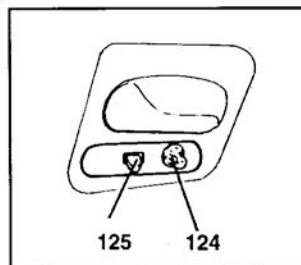
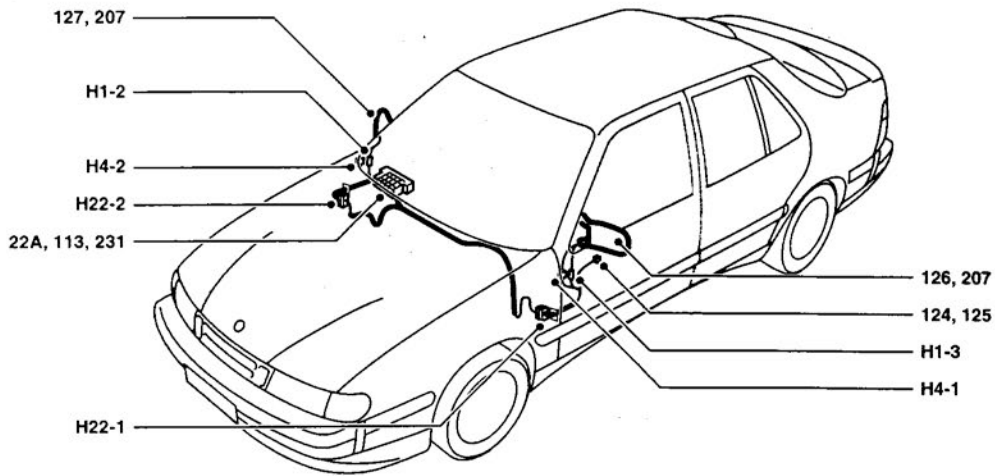

C812W-4556

Central locking system

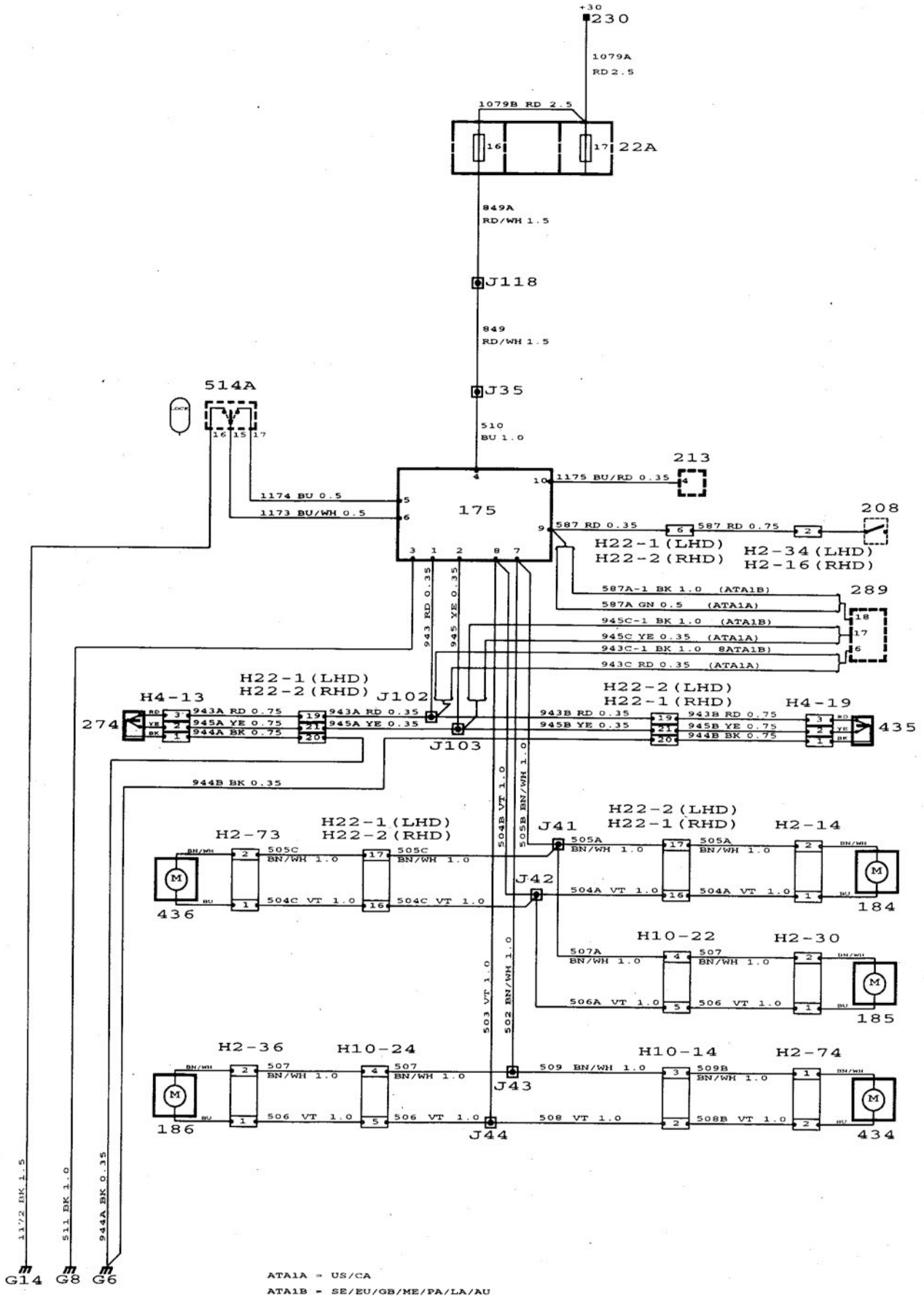

Description of operation

With the key in the driver's door or front passenger's door, all the car's doors and fuel tank filler cap can be locked and unlocked centrally.

Control module 175 for the central locking system is continuously supplied with current via fuse 16.

The control module is controlled from microswitch 274 in the driver's door, microswitch 435 in the passenger's door or from a switch in switch unit 386 in the centre console.

When the doors are locked, terminal 2 of the control module is grounded and current is supplied for 0.7 seconds to all actuating motors, closing the locks. The motors are grounded via terminal 8.

When the switch 386 in the centre console is activated by pressing the "LOCK" symbol on the switch, terminal 5 of the control module is grounded and current is supplied for 0.7 seconds to all actuating motors, closing the locks. The motors are grounded via terminal 8.

When the driver's or passenger's door is unlocked, terminal 1 of the control module is grounded and current is supplied for 0.7 seconds to all actuating motors, opening the locks. The motors are grounded via terminal 7.

When the switch in the centre console is activated by pressing the part of the switch without a symbol, terminal 6 of the control module is grounded and current is supplied for 0.7 seconds to all actuating motors, opening the locks. The motors are grounded via terminal 7.

If the driver's door is not completely closed and an attempt is made to use the central locking system from this door or from the switch in the centre console, it will not be possible to lock the doors.

If an attempt is made to use the central locking system from the passenger's door when the driver's door is not completely closed the control module will lock the doors, only to unlock them again shortly afterwards.

Fault diagnosis hints

General

- 1 Check that fuse 16 is intact and supplied with current.
- 2 Check the connectors, wiring harness and ground connections.
- 1 Check that terminal 4 of the control module is supplied with current.
- 2 Check that current is supplied to pin 8 of the control module when the doors are being unlocked and to pin 7 when they are being locked.

Important:

Control module terminals 7 and 8 are live for only about 1 second, so readings on them must be taken at the precise moment when the locking mechanism changes position. In the inactivated position, both outputs are grounded.

Note also that the actuating motors (on testing) should be connected only to terminals 7 and 8 of the control module. Otherwise the motors could be overloaded and damaged.

Components

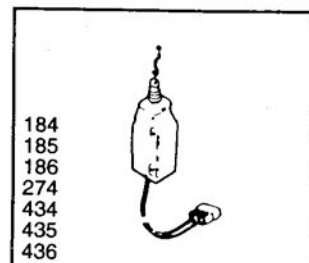
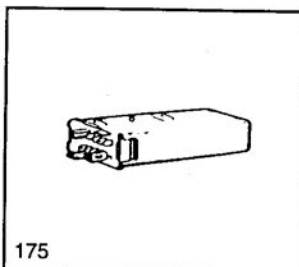
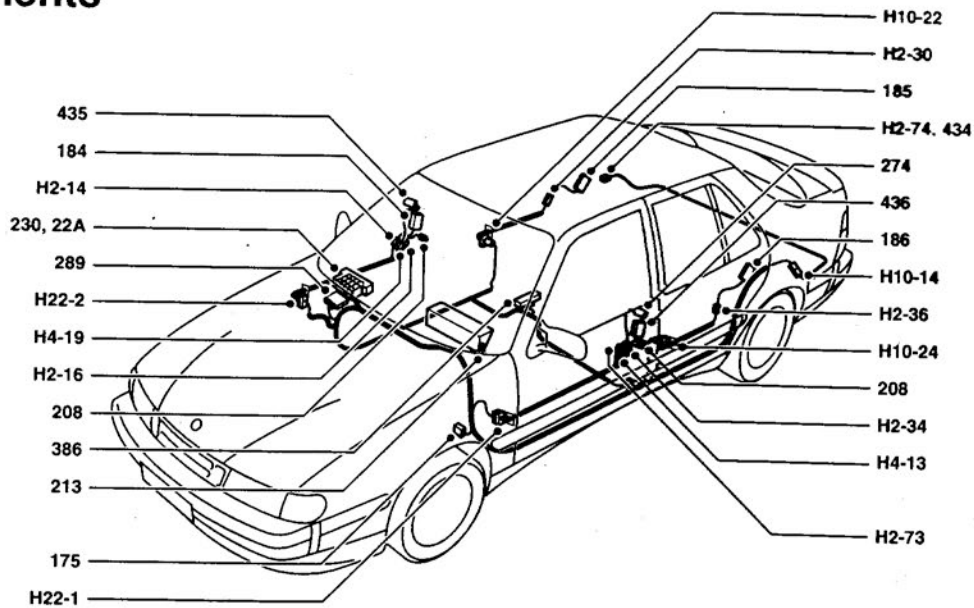

CR96W-4557

Electrically operated tailgate release

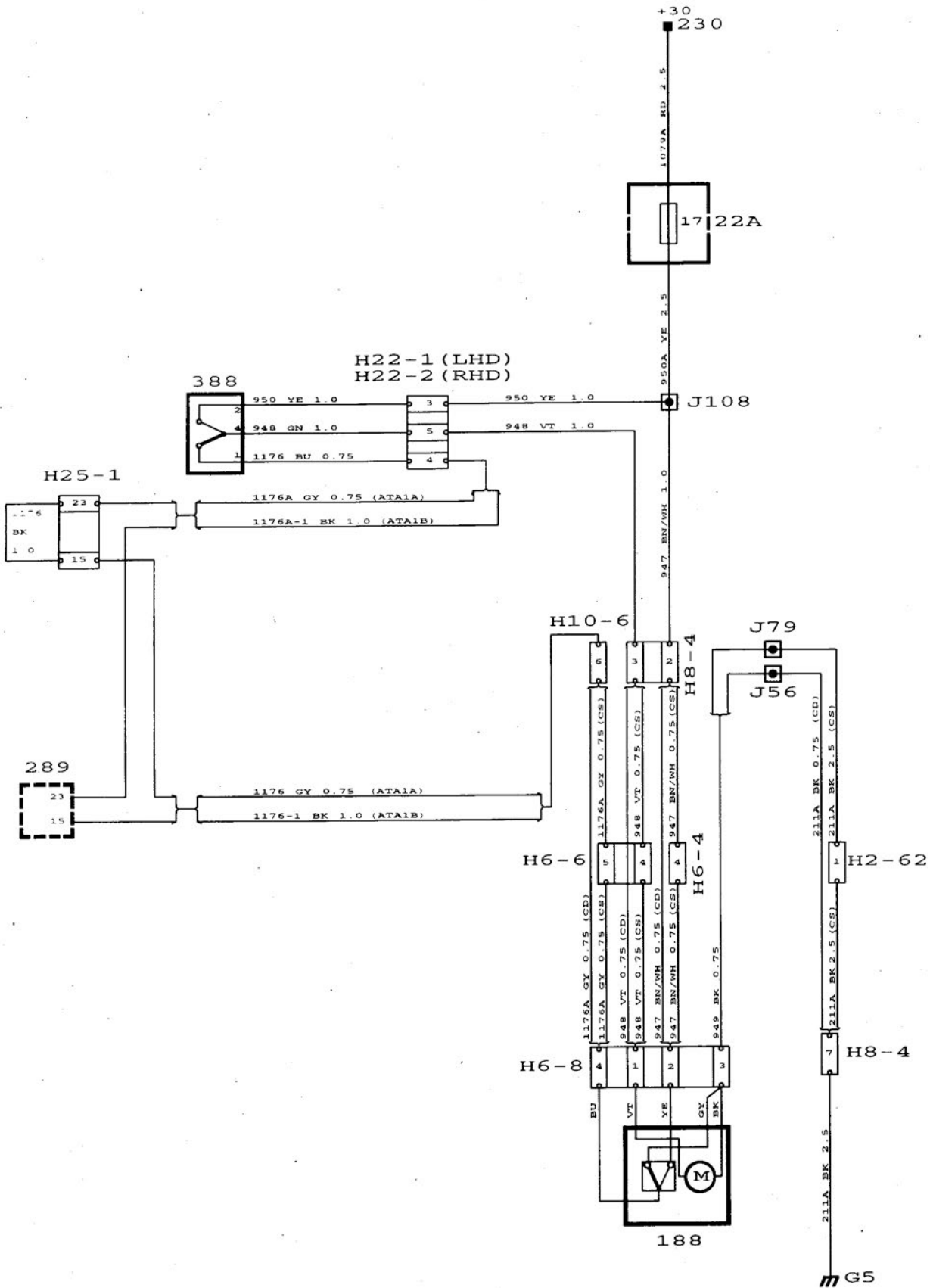

ATA1A = US/CA
 ATA1B = SE/EU/GB/ME/PA/LA/AU

Description of operation

The tailgate can either be opened using switch 388 in the driver's door or with the key in the tailgate. When the tailgate is opened using switch 388, current (+30 circuit) is supplied from fuse 17 via the switch to motor 188.

A spring in motor 188 ensures that it always returns to the locked position. To prevent the motor from re-coiling, it is damped by being grounded on both sides.

Fault diagnosis hints

- 1 Check that current is **supplied** to pin 2 of switch 388.
- 2 Check fuse 17.
- 3 Check the connectors, **wiring harness** and **ground connections**.

Component locations

22A	Fuse board behind the cover flap in the glove box.
188	Central locking motor, tailgate, in the tailgate.
230	Distribution terminal (+30 circuit) in main fuse box behind the glove box.
289	Control module, anti-theft alarm, under the dashboard on the right-hand side behind the knee shield.
388	Switch, electrically operated tailgate release, in the driver's door. <i>2-pin connector</i>
H2-62	In the tailgate on the left. <i>6-pin connectors</i>
H6-4	In the tailgate to the left beside the rear window.
H6-6	To the right of the rear window wiper motor.
H6-8	In the tailgate next to motor 188. <i>8-pin connector</i>
H8-4	By the left-hand rear wheel housing. <i>10-pin connector</i>
H10-6	Beside the left-hand rear wheel housing. <i>22-pin connectors</i>
H22-1	Behind the cable entry in the left-hand A pillar.
H22-2	Behind the cable entry in the right-hand A pillar. <i>25-pin connector</i>
H25-1	Under the glove box door beside the anti-theft alarm control module.
G5	Under the rear seat on the left-hand side.

Components

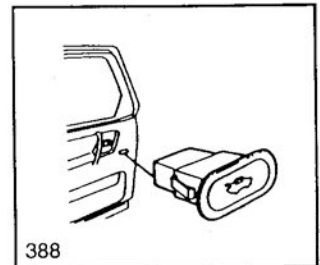
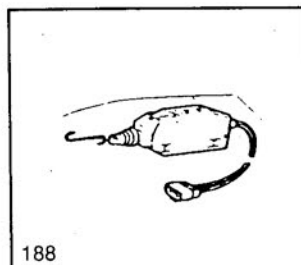
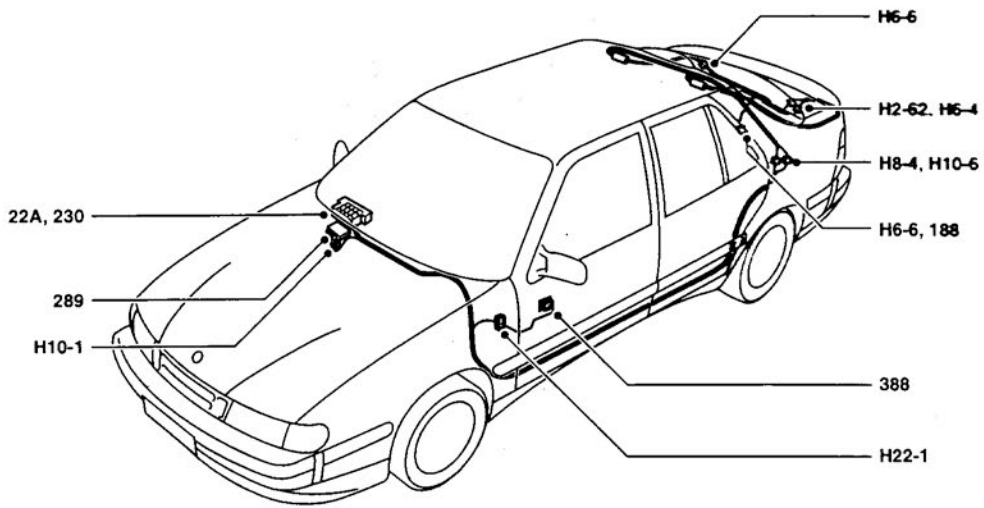

C832W-4558

Cruise Control system

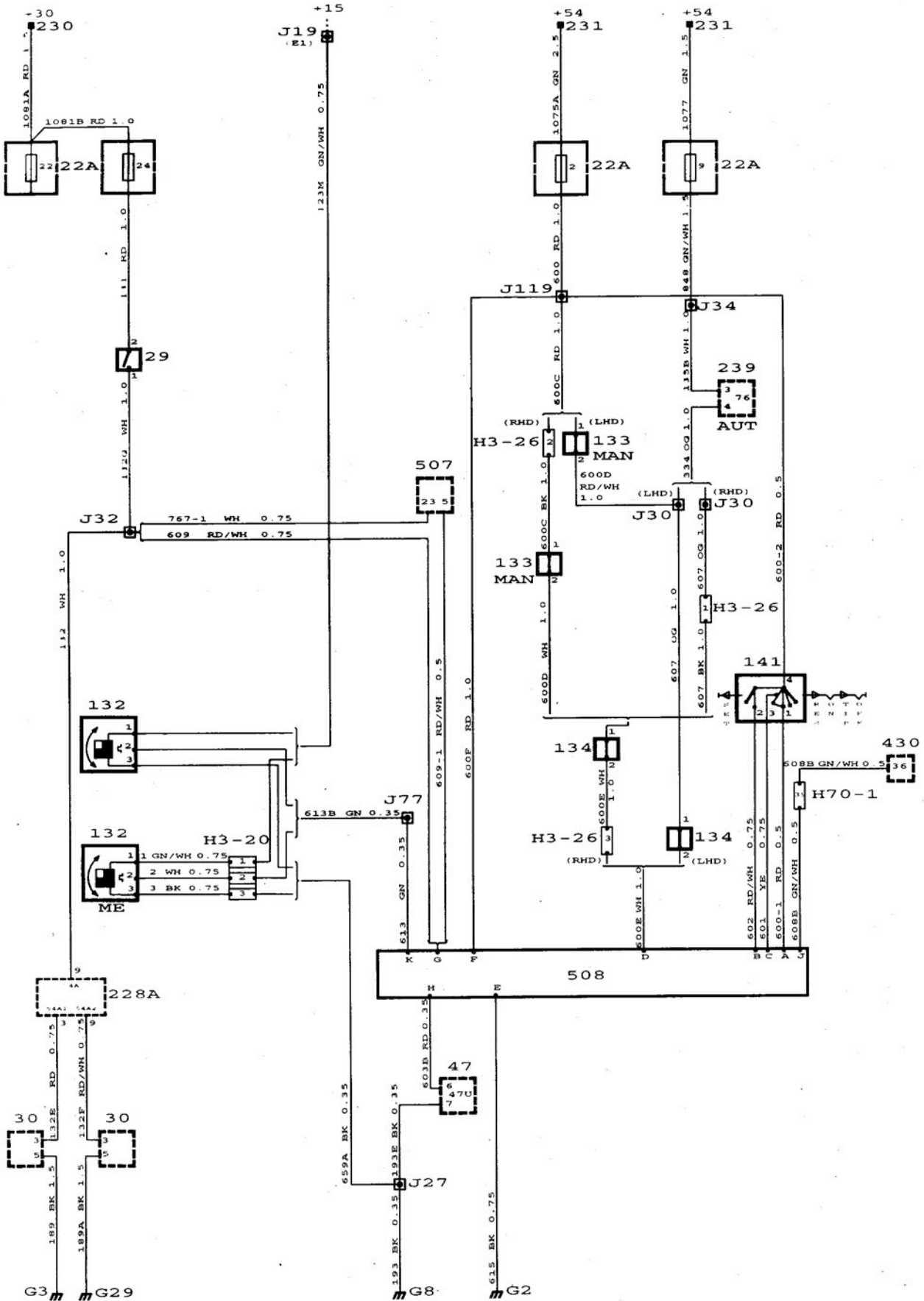

Description of operation

The Cruise Control system consists of the following components:

- Control module 508.
- Vehicle speed sensor 132.
- Cruise Control switch 141.
- Pedal switches 133 (manual gearbox) and 134.
- Brake light switch 29 or signal from TCS control module 507 for V6.

Control module 508

The control module incorporates an electric stepping motor, which mechanically controls the Cruise Control cable.

Current (+54 circuit) is supplied to control module pin F via fuse 2.

Vehicle speed sensor 132

The sensor continuously reads the speed and supplies this data to the control module via pin K.

Switch 141

The Cruise Control system is engaged using switch 141. The different positions of the switch are:

Position **ON**: Current is supplied to the control module via pin A.

Position **SET**: Current is supplied to the control module via pin B and the speed of the car is read using vehicle speed sensor 132.

Position **TIP**: Between ON and OFF on the switch is a TIP position. When this position is selected, the current supplied to pin A of the control module is shut off and the Cruise Control is disconnected. When the button is released, it springs back to the ON position, at which point current is again supplied to pin A of the control module.

Position **RESUME**: Restores the selected speed stored in the control module memory after either of pedal switches 133 and 134 has been activated. Current is supplied to control module pin C.

Pedal switches 133 and 134

When the brake or clutch pedal is depressed, the current supplied to pin D of the relevant pedal switch, 133 or 134, is cut off and the Cruise Control system is disengaged.

Cars with Trionic

On cars equipped with the Trionic engine management system, a turbo engine and the Cruise Control system, terminal 36 of Trionic control module 430 receives a signal from pin J of the Cruise Control system's control module to the effect that the system is operative.

This results in more even control of the vehicle's speed.

Automatic transmission

When the selector lever is in one of the drive positions, switch 76 in selector lever 239 is closed. Pin D then receives a 12 V signal which means that the Cruise Control system can be activated. This means that the system is not operative until the selector lever is in one of the drive positions.

Indicator lamp 47U

Cars for certain markets are equipped with a CRUISE indicator lamp, 47U, which lights up when switch 141 is set to the ON position.

Fault diagnosis hints

The Cruise Control system is activated by turning the ignition switch to the Drive position.

Position **ON** :

- 1 Check that fuse 2 is intact and supplied with current (manual gearbox).
- 2 Check that fuse 9 is intact and that current is supplied to it and to switch 76 (automatic transmission).
- 3 Check the current supplied to terminal 4 of switch 141 and terminal A of control module 508.
- 4 Check the current supplied to terminal 1 of vehicle speed sensor 132.

Position **A—B SET** (spring-loaded):

- 1 Check the current supplied to terminal 2 of the switch and to terminal B of the control module.

Position **RESUME** (spring-loaded):

- 1 Check the current supplied to terminals 1 and 3 of the switch and to terminals A and C of the control module.

Check the connections, connectors and grounding points for the wiring harness in question.

The Cruise Control system is described in detail in Service Manual "3:5 Electrical system, cruise control".

Component locations

22A	Fuse board behind the cover flap in the glove box.	G8	Grounding point, dashboard, by the left-hand front loudspeaker socket.
29	Brake light switch beside the brake pedal.	G29	Grounding point, luggage compartment, on the right-hand side adjacent to the right-hand rear light cluster.
30	Brake lights in the rear light clusters.		
47U	Cruise Control indicator lamp, in the main instrument display panel.		
76	Idling speed increase switch, automatic transmission, in transmission range switch 239 adjacent to the selector lever.		
132	Vehicle speed sensor, in the speedometer.		
133	Clutch pedal switch, Cruise Control, on the clutch pedal.		
134	Brake pedal switch, Cruise Control, on the brake pedal.		
141	Switch, speed control, on the direction indicator stalk switch on the left-hand side of the steering wheel.		
228A	Filament monitor, rear lamps, in luggage compartment on the left-hand side.		
230	Distribution terminal (+30 circuit) in main fuse box behind the glove box.		
231	Distribution terminal (+54 circuit) in main fuse box behind the glove box.		
239	Transmission range switch beside the selector lever.		
430	Saab Trionic control module, in engine bay on the left behind the bulkhead partition.		
507	Control module, TCS V6, under the left-hand seat.		
508	Control module, Cruise Control, adjacent to the battery tray.		
	<i>3-pin connectors</i>		
H3-20	Behind the main instrument display panel adjacent to the speedometer (ME).		
H3-26	(RHD) above the pedal bracket beside the pedal switches.		
	<i>70-pin connector</i>		
H70-1	In the engine bay, behind the bulkhead partition.		
G2	Grounding point, behind the battery on the left-hand wheel housing.		
G3	Grounding point, luggage compartment, on the left-hand side adjacent to the left-hand rear light cluster.		

Components

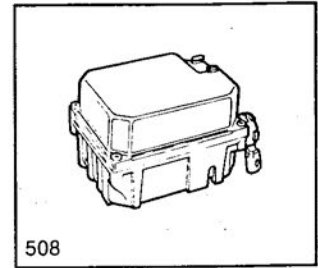
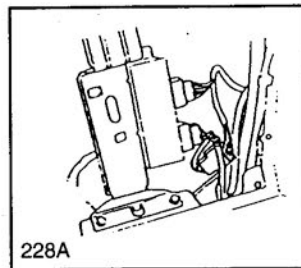
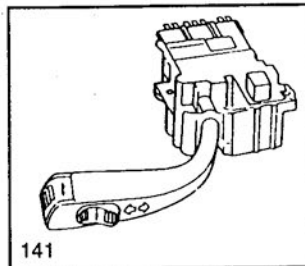
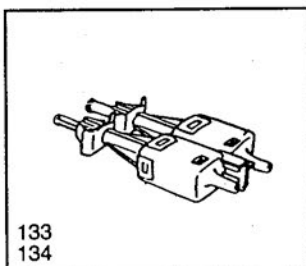
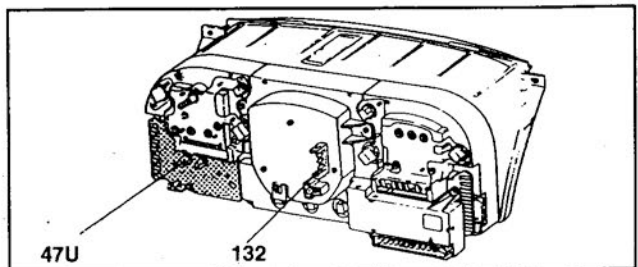
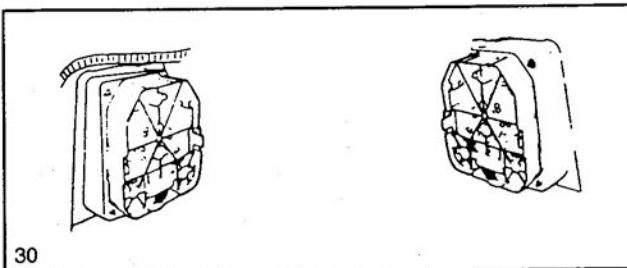
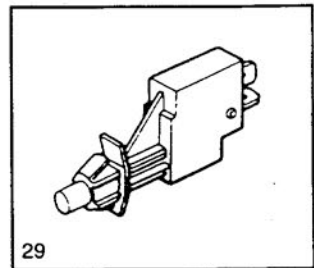
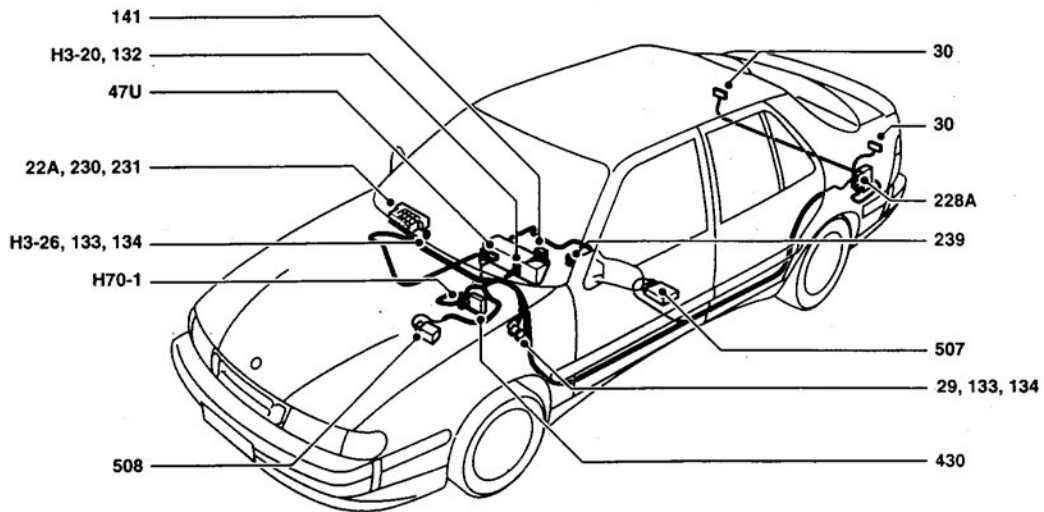

C868W-4559

Description of operation

Cars which are not equipped with a factory-fitted audio system are pre-wired for radio installation by means of two 8-pin connectors, one for power supply, etc. and one for the connection of loudspeakers. Cars for the EU market are also fitted with a 2-pin connector, H2-81, providing the power supply for an amplifier or similar equipment.

The connectors for the motorized aerial are situated behind the luggage compartment trim on the left-hand side in the luggage compartment.

Fault diagnosis hints

- 1 Check the radio's power supply and ground connections.
- 2 Check the fuses integrated into the radio-cassette and amplifier.
- 3 Check the connectors.
- 4 Check the wiring harness for continuity and shorting to ground.

Component locations

- 16 Rheostat (lighting for controls), on the dashboard between the steering wheel and driver's door.
- 20 Ignition switch, on the right-hand side of the steering column.
- 22A Fuse board behind the cover flap in the glove box.
- 230 Distribution terminal (+30 circuit) in main fuse box behind the glove box.
- 266 Loudspeaker sockets, two in the dashboard, two in the parcel shelf.
- 267
(H2-81)
(H8-8)
(H8-9) 2-pin and 8-pin connectors for radio connection, in the centre console.
- 2-pin connector*
- H2-42 Beside the prepared location for the motorized aerial, on the left-hand side at the rear.
- 10-pin connector*
- H10-14 In the luggage compartment on the left-hand side beside the filament monitor.
- G8 Grounding point, dashboard, by the left-hand front loudspeaker socket.

Components

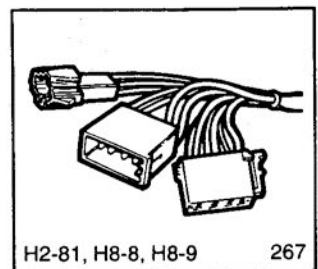
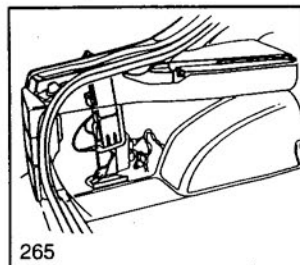
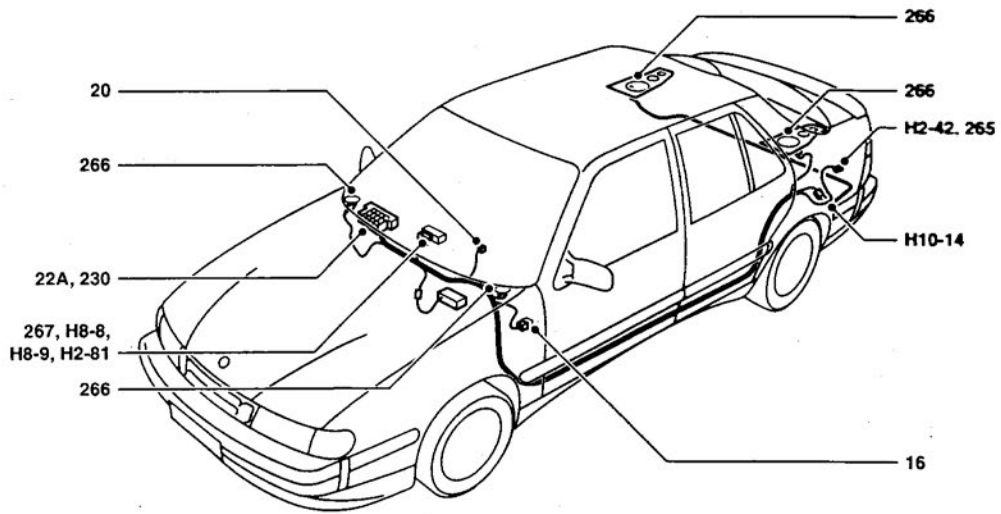

C367W-4560

Premium Audio System EU

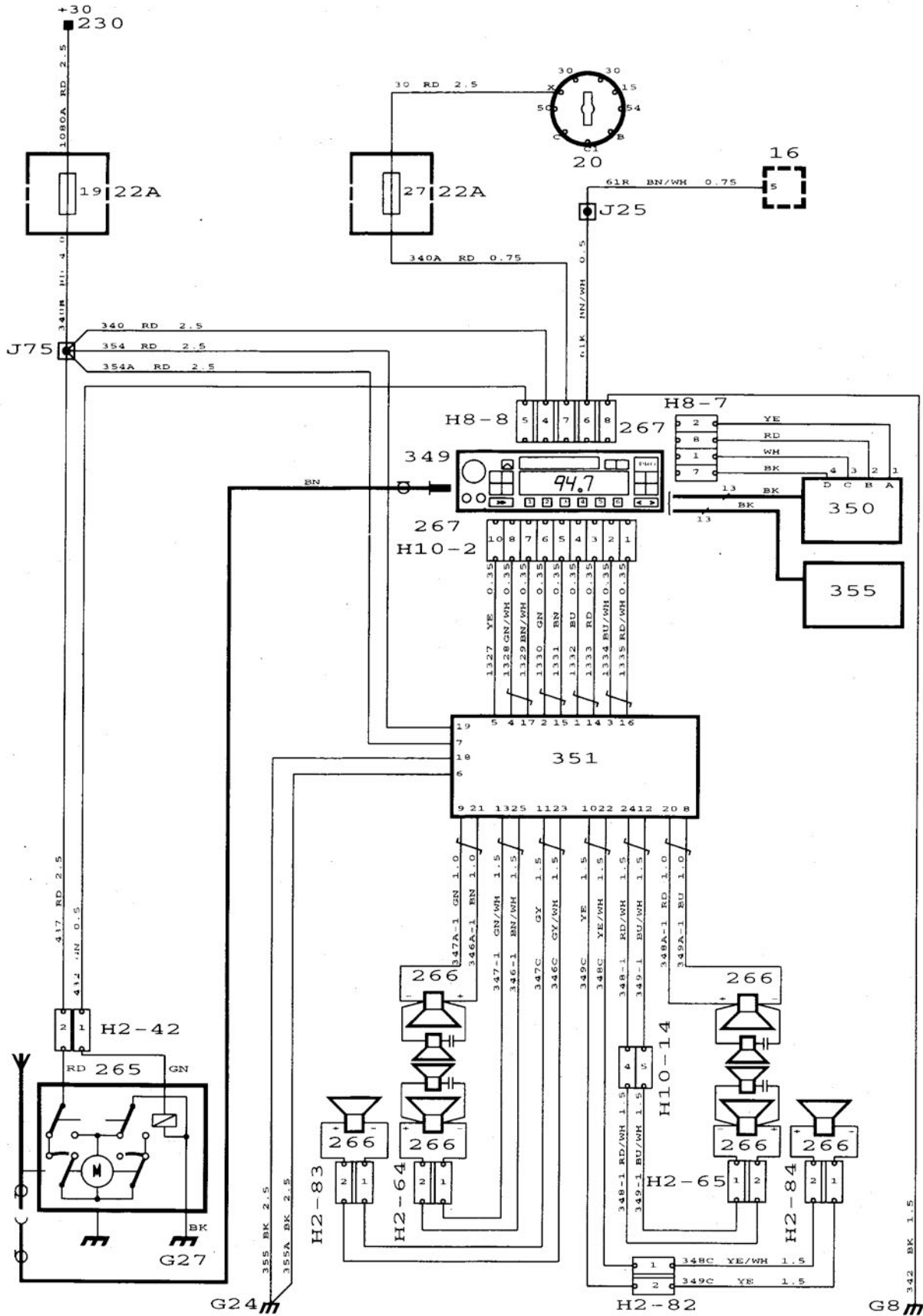

Premium Audio System US

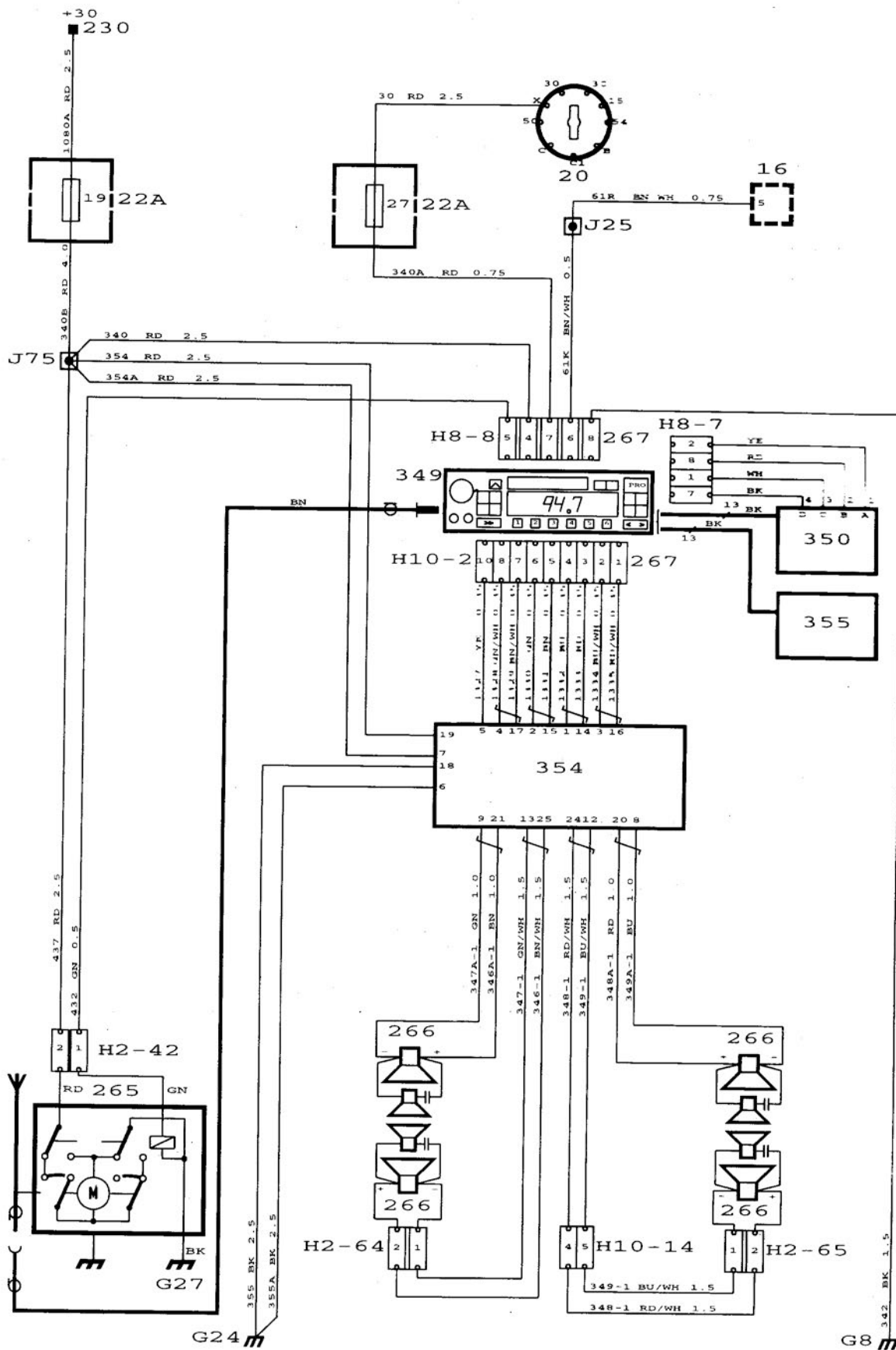

Description of operation

For certain markets, the Premium Audio System is factory-fitted.

The following components are included:

- Radio-cassette player 353.
- Wide-band amplifier 354.
- Wide-band speakers 266.
- Motorized aerial 265.
- CD player 350.
- CD changer 355 (option).

Power supply

The radio-cassette player, motorized aerial and CD player/changer (via the radio) are supplied with current via fuses 19 and 27. The amplifier is supplied with current via fuse 19.

For more information on the audio system, see Service Manual "3:5 Electrical System, Audio System".

Fault diagnosis hints

- 1 Check the radio's power supply and ground connections.
- 2 Check the fuses integrated into the radio-cassette and amplifier.
- 3 Check the connectors.
- 4 Check the wiring harness for continuity and shorting to ground.

Component locations

- 20 Ignition switch, on the right-hand side of the steering column.
- 22A Fuse board behind the cover flap in the glove box.
- 230 Distribution terminal (+30 circuit) in main fuse box behind the glove box.
- 265 Motorized aerial, on the left-hand side at the rear.
- 266 Loudspeakers, two in the dashboard, two in the parcel shelf.
- 267 Connector for radio-cassette player, in the centre console.
(H2-81 for EU)
(H8-7)
(H8-8)
(H10-2)
- 349 Radio-cassette player in the centre console.
- 350 CD player in the centre console.
- 355 Automatic CD changer in the luggage compartment to the left beside the motorized aerial.
- 2-pin connectors*
- H2-42 Adjacent to the motorized aerial at the rear on the left-hand side.
- H2-64 Beside the rear left-hand loudspeaker.
- H2-65 Beside the rear right-hand loudspeaker.
- 10-pin connector*
- H10-14 In the luggage compartment on the left-hand side beside the filament monitor.
- G8 Grounding point, dashboard, by the left-hand front loudspeaker socket.
- G24 Grounding point, right-hand front seat member.
- G27 Grounding point, motorized aerial.

Components

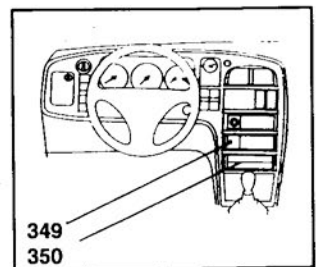
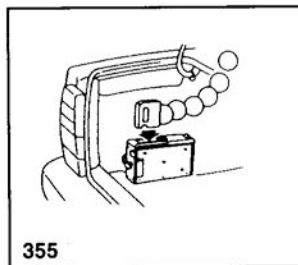
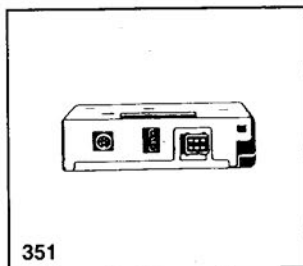
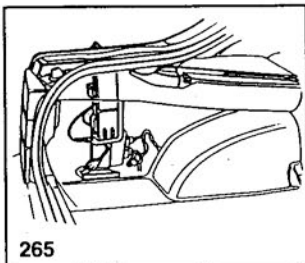
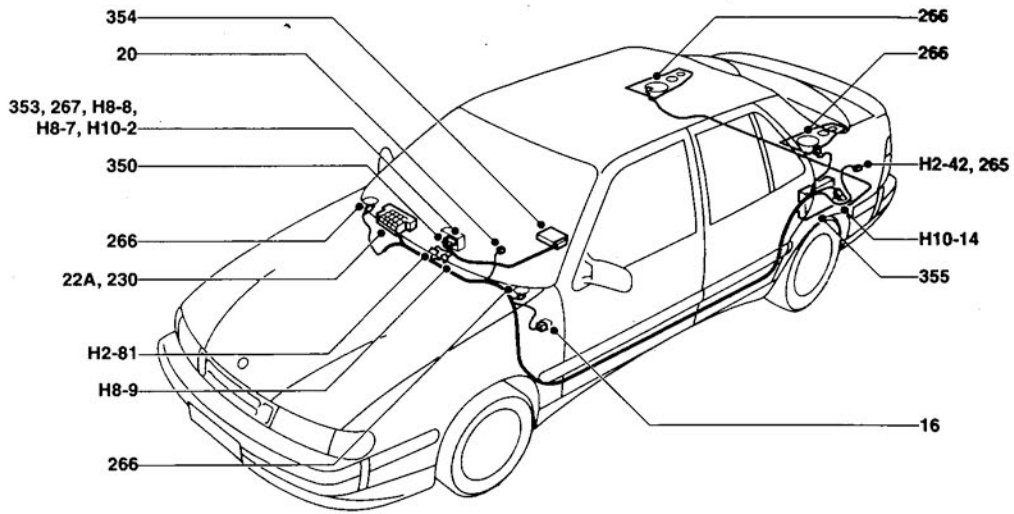

C367W-4562

Prestige Audio System US/CA

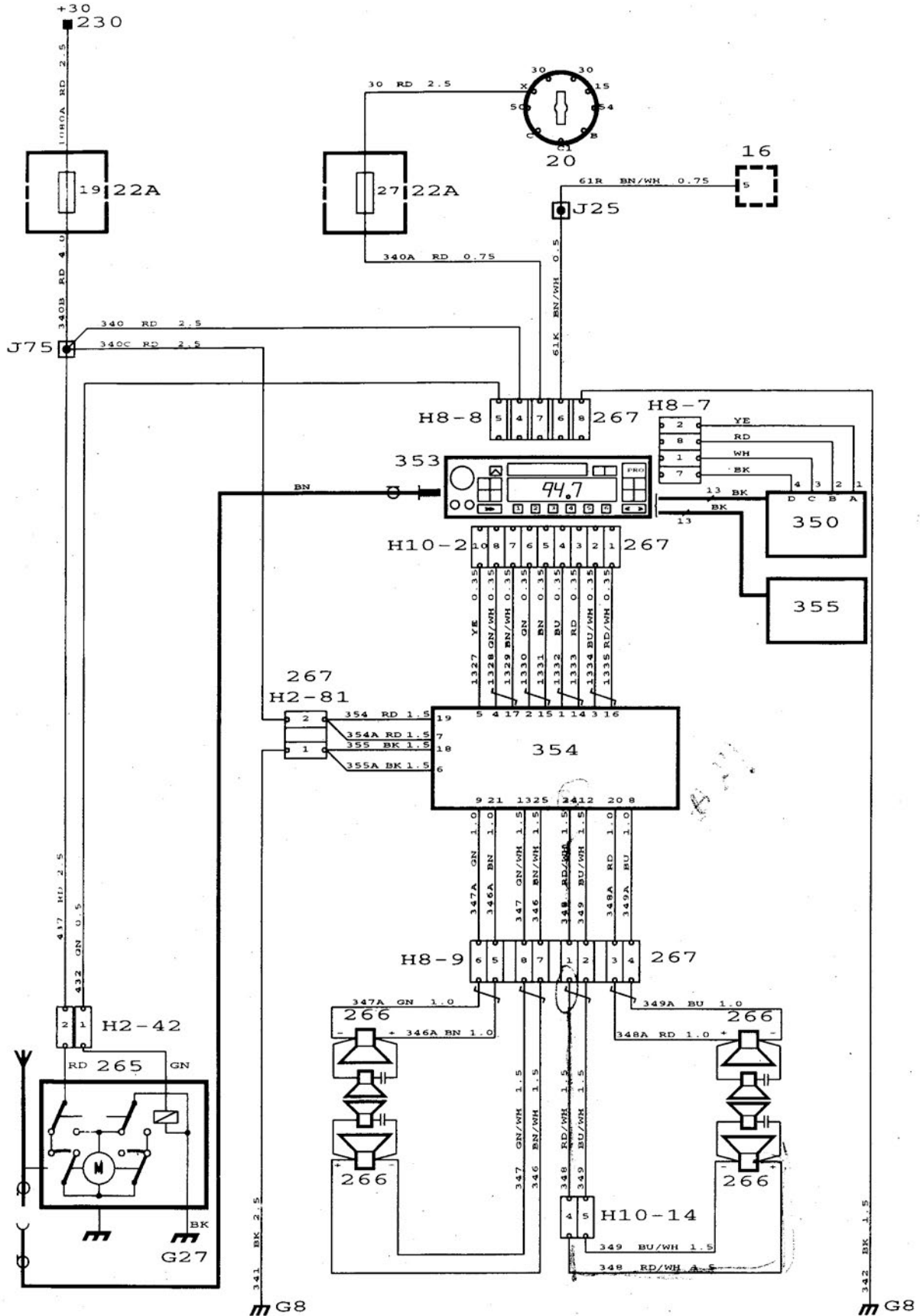

Description of operation

In the US and CA markets it is possible to have the Prestige Audio System fitted.

The following components are included:

- Radio-cassette player 353.
- Wide-band amplifier 351.
- Wide-band loudspeakers 266.
- Motorized aerial 265.
- CD player 350.
- CD changer 355 (option).

Power supply

The radio-cassette player, motorized aerial and CD player/changer (via the radio) are supplied with current via fuses 19 and 27. The amplifier is supplied with current via fuse 19.

For more information on the audio system, see Service Manual "3:5 Electrical System, Audio System".

Fault diagnosis hints

- 1 Check the radio's power supply and ground connections.
- 2 Check the fuses integrated into the radio-cassette and amplifier.
- 3 Check the connectors.
- 4 Check the wiring harness for continuity and shorting to ground.

Component locations

20	Ignition switch, on the right-hand side of the steering column.
22A	Fuse board behind the cover flap in the glove box.
230	Distribution terminal (+30 circuit) in main fuse box behind the glove box.
265	Motorized aerial, on the left-hand side at the rear.
266	Speakers, four in the dashboard and six in the parcel shelf.
267 (H8-7) (H8-8) (H8-9) (H10-2)	Connector for the radio-cassette player, in the centre console.
349	Radio-cassette player in the dashboard.
350	CD player in the centre console.
351	Wide-band amplifier.
355	CD changer in the luggage compartment, on the left-hand side.
	<i>2-pin connectors</i>
H2-42	Adjacent to the motorized aerial at the rear on the left-hand side.
H2-64	Beside the rear left-hand loudspeaker.
H2-65	Beside the rear right-hand loudspeaker.
H2-82	Connector between the main wiring and the rear subwoofer wiring.
H2-83	Beside the rear left-hand subwoofer speaker.
H2-84	Beside the rear right-hand subwoofer speaker.
	<i>10-pin connector</i>
H10-14	In the luggage compartment on the left-hand side beside the filament monitor.
G8	Grounding point, dashboard, by the left-hand front loudspeaker socket.
G24	Grounding point, in the right-hand seat member.
G27	Grounding point, motorized aerial.

Components

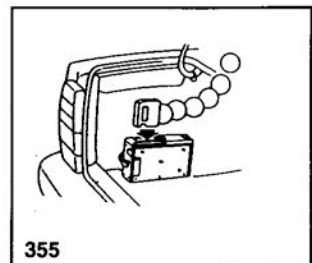
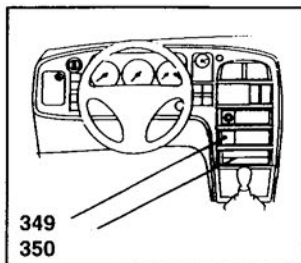
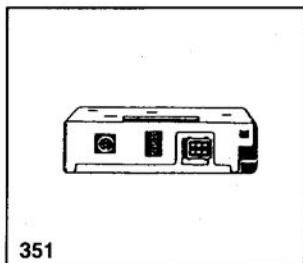
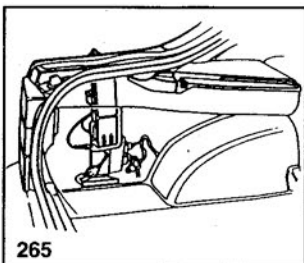
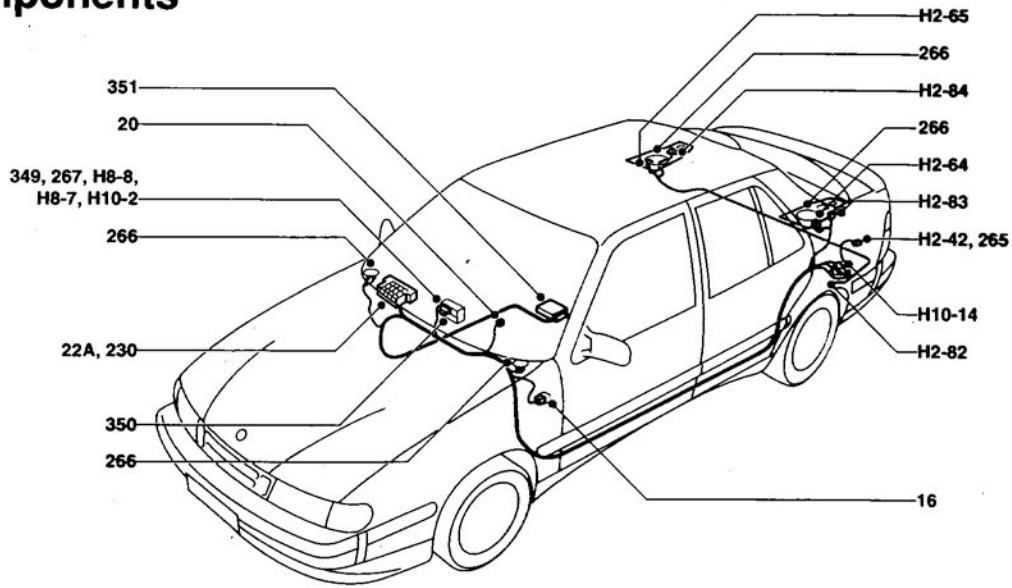

C367W-4561

Mobile telephone installation pre-wiring

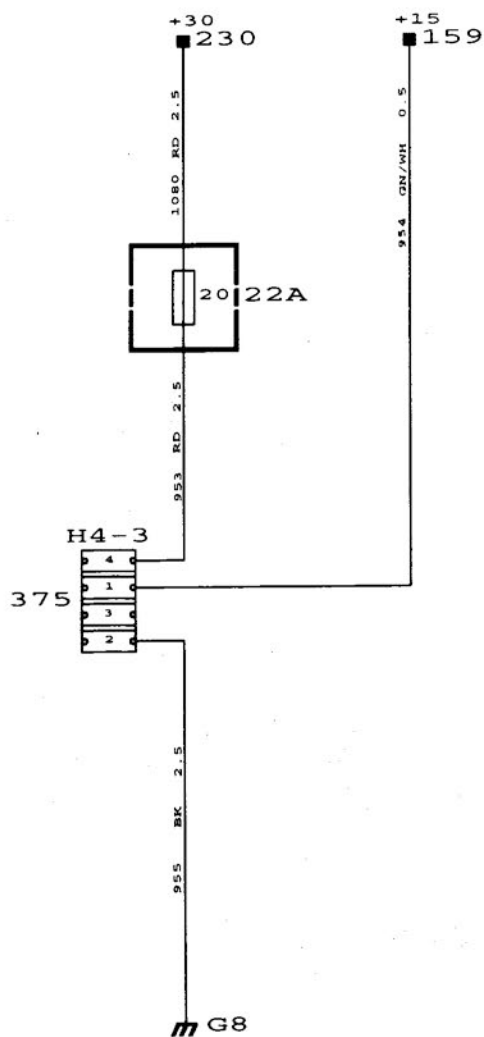

Description of operation

Cars for certain markets are pre-wired for the installation of a mobile telephone, for instance. Current from fuse 20 (+30 circuit) and fuse 13 (+15 circuit) is supplied via a special 4-pin connector, which also has a ground connection.

Important:

When fitting a mobile telephone, etc., the +15 lead cannot be used as a power supply lead and must only be used for operating relays.

Fault diagnosis hints

- 1 Check that fuse 20 is intact and supplied with current.
- 2 Check that current is supplied to pin 4 of 4-pin connector 372 (H4-3).
- 3 Check that fuse 13 is intact and supplied with current.
- 4 Check that current is supplied to pin 1 of 4-pin connector 375 (H4-3).

Component locations

- 22A Fuse board behind the cover flap in the glove box.
- 159 Distribution terminal (+15 circuit) in main fuse box behind the glove box.
- 230 Distribution terminal (+30 circuit) in main fuse box behind the glove box.
- 375 (H4-3) Mobile telephone connector (4-pin) under the dashboard to the right behind the radio compartments.
- G8 Grounding point, dashboard, by the left-hand front loudspeaker socket.

Components

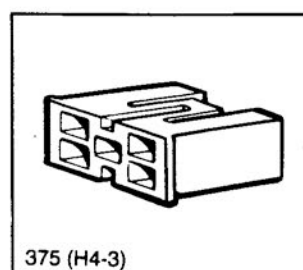
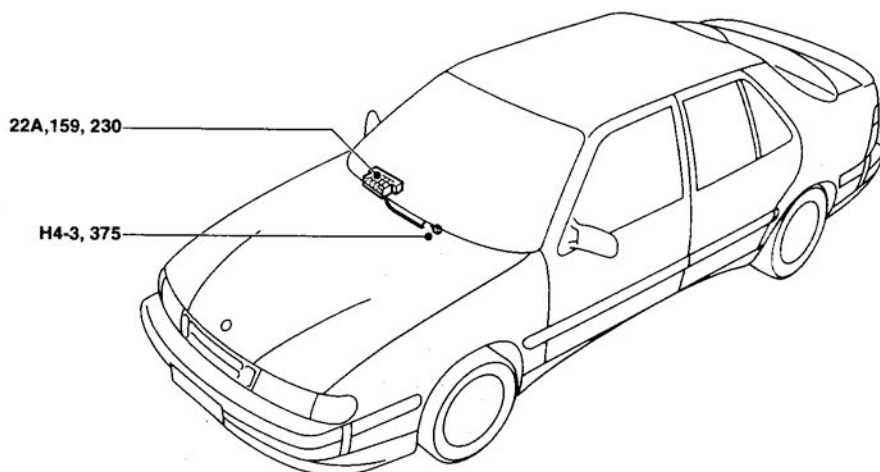

C367W-4563

Cigarette lighter

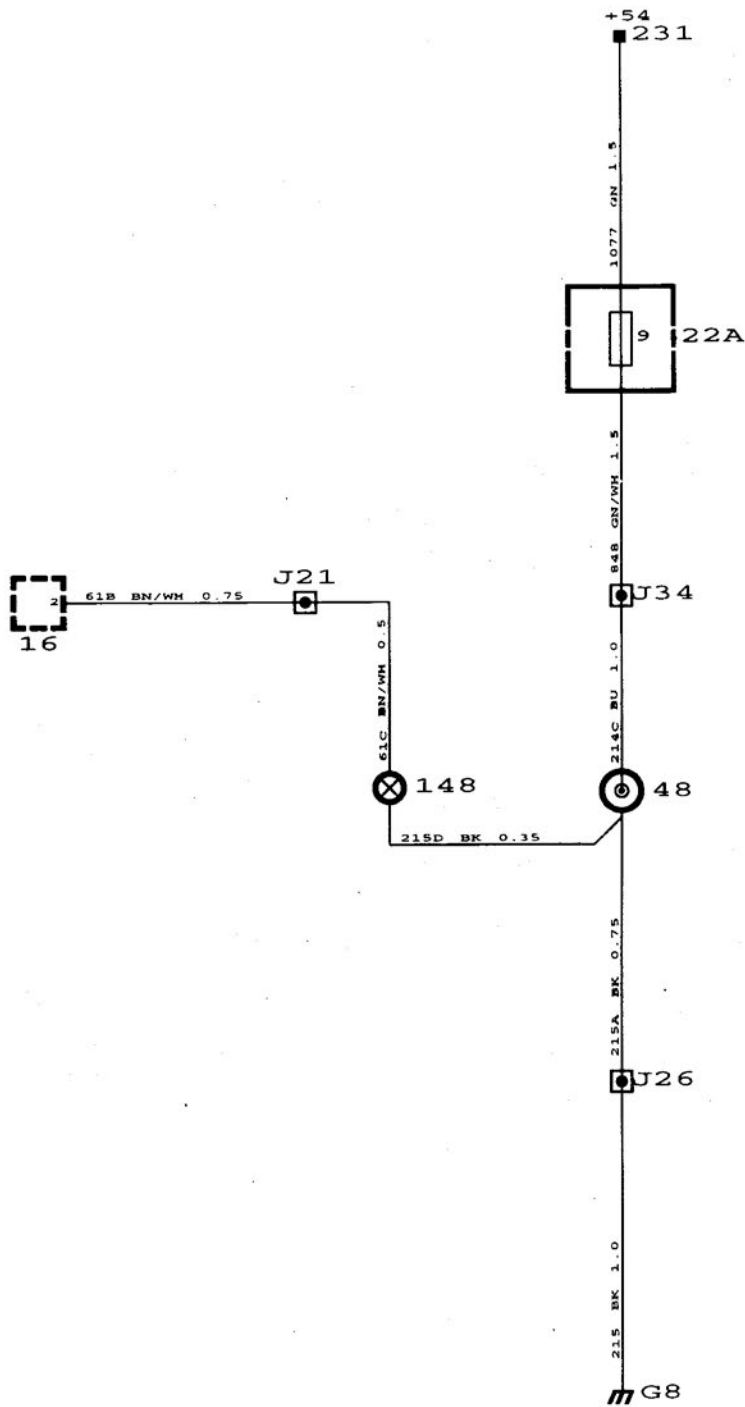

Description of operation

When the ignition switch is in the Drive position, positive voltage is supplied to cigarette lighter 48 via fuse 9 and the terminal block (+54 circuit). The circuit is closed when the cigarette lighter is pressed in.

Ashtray lighting 148 is controlled by the rheostat for lighting for controls.

Fault diagnosis hints

- 1 Check that fuse 9 is intact and supplied with current.
- 2 Check the cigarette lighter filament.
- 3 Check the ground connection.

Component locations

- 16 Rheostat, lighting for controls, on dashboard between the steering wheel and driver's door.
- 22A Fuse board behind the cover flap in the glove box.
- 48 Cigarette lighter, on the centre console beside the ashtray.
- 148 Ashtray lighting, front cigarette lighter, in the centre console.
- 231 Distribution terminal (+54 circuit) in main fuse box behind the glove box.
- G8 Grounding point, dashboard, by the left-hand front loudspeaker socket.

Components

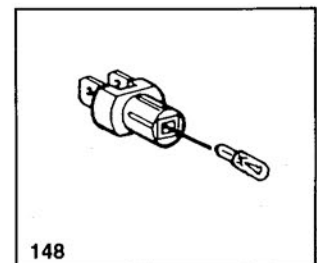
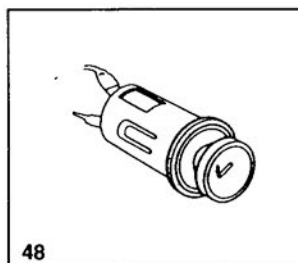
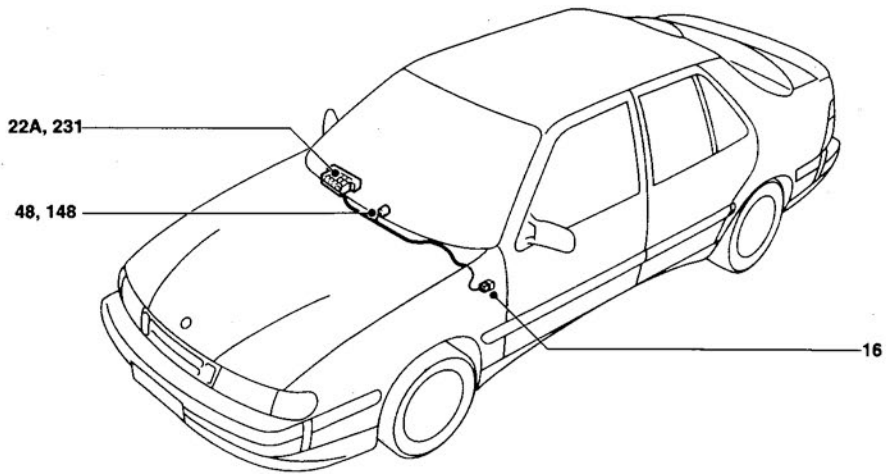

C381W-4564

ABS anti-lock brakes (Mark IV)

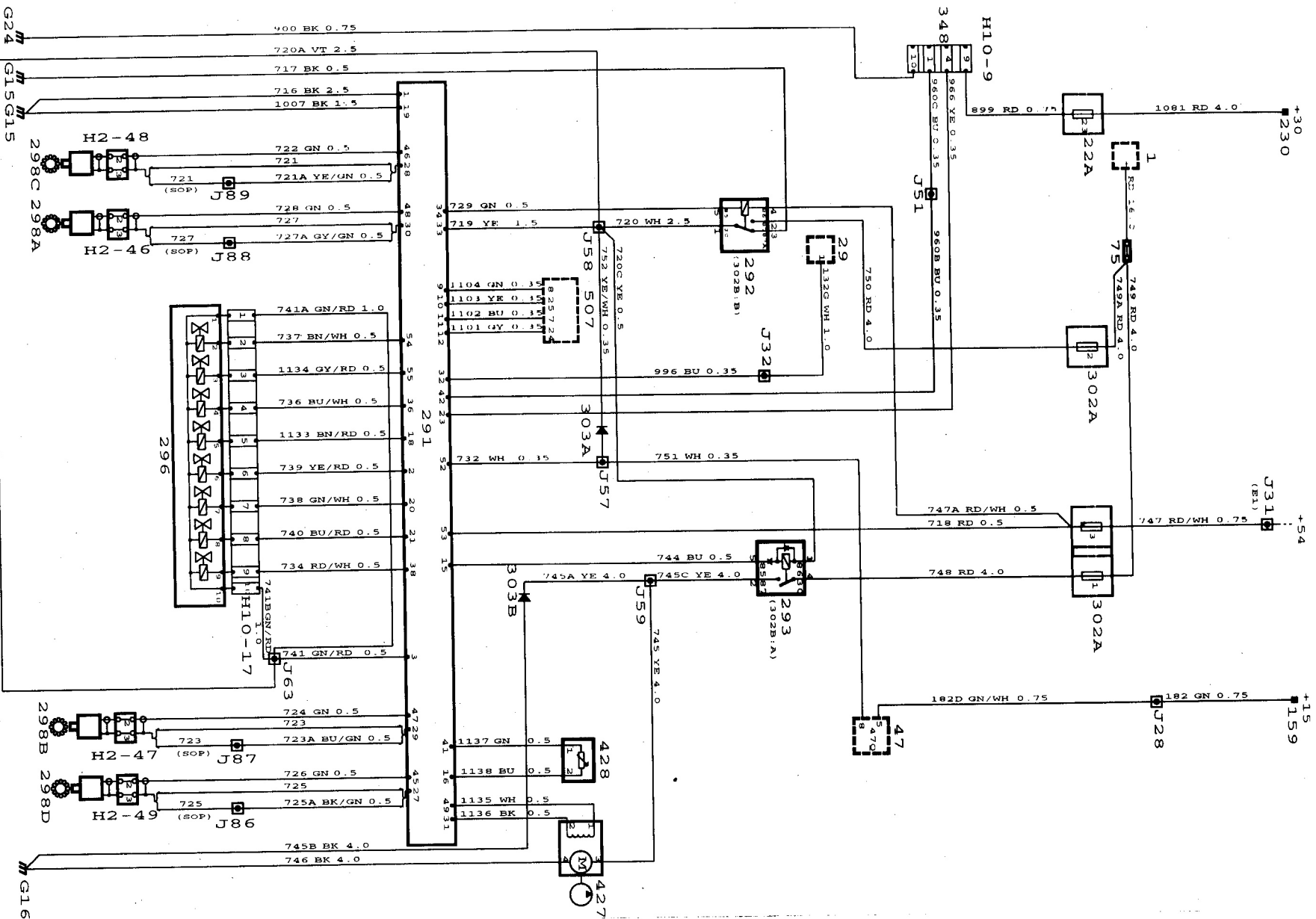

Description of operation

The brake system in cars with anti-lock brakes (ABS) is electrically controlled and monitored. (ABS = Anti-lock Braking System).

This manual contains only a description of the electrical function of the system, while Service Manual "5:2 Anti-lock Braking System (ABS Mark IV)" describes the system in greater detail.

The system consists of the following:

- A master cylinder with vacuum servo.
- A hydraulic unit with
 - inlet valves
 - outlet valves
 - hydraulic pump.

The system works in two different modes.

ABS mode: The hydraulic unit only works in the ABS mode and regulates the pressure to the inlet and outlet valves with the help of the hydraulic pump.

The control module receives data on the wheel speed from a sensor on each wheel. If the wheels tend to lock,

the control module regulates the power of the brakes, i.e. the pressure in the brake lines, with the help of electronic control valves. The braking force on the wheels is individually controlled.

Normal mode: In normal mode, the system functions as a conventional braking system and servo power is achieved with the engine vacuum.

A warning lamp on the dashboard is connected to the brake system, ABS system warning lamp (ANTI-LOCK).

The components in the ABS system receive voltage via fuses on relay and fuse board 302 in the engine bay on the bulkhead partition.

Fuse 3 protects control module 291, fuse 2 valve block 296 via relay 292 and fuse 1 protects pump motor 427 via relay 293.

In addition, warning lamp 47Q receives current (+15 circuit) via fuse 13 when the ignition switch is in the Drive or Start position.

Power supply

When the ignition switch is turned to the Drive position, pin 53 of the control module is supplied with current (+54 circuit). The control module then grounds main relay 292 via pin 34 and the relay operates. The unit is then supplied with current (+30 circuit) for actuation of the brake system control valves.

Function of the warning lamp when starting

When the ignition key is turned to the Start position, the current (+54 circuit) supplied to main relay 292 is cut off and the relay releases. The warning lamp then lights up when it is grounded via diode 303A and the relay contacts.

When the ignition switch is subsequently turned to the Drive position, current (+54 circuit) is again supplied to main relay 292, which starts to operate. The control module now grounds the warning lamp via terminal 52. The lamp lights up briefly as a check.

Hydraulic pressure

Every time the car is started, the hydraulic pump also starts in order for the control module to be able to test the pump.

The hydraulic pump only works in the ABS mode.

Brake light switch

During braking, the brake light switch supplies data to the control module via pin 32. As a result, the system reacts more rapidly.

Control module 291

Control module 291 is continually supplied with data about the speed of the wheels from the four wheel speed sensors:

298A front left
298B front right
298C rear left
298D rear right

On the basis of data from the sensors on the speed of the wheels, the control module regulates the braking force via the eight hydraulic valves 296 in the hydraulic unit.

Control takes place individually on each wheel. Two valves, one inlet and one outlet, are provided for each function.

Left-hand front wheel:

IFL inlet valve
OFL outlet valve

Right-hand front wheel:

IFR inlet valve
OFR outlet valve

Left-hand rear wheel:

IRL inlet valve
ORL outlet valve

Right-hand rear wheel:

IRR inlet valve
ORR outlet valve

When no current is supplied, the inlet valves are open and the outlet valves are closed.

Pedal position sensor 428

Normally when the car is braked, the system is in the normal mode. However, if the control module receives information from any of the wheel sensors suggesting that one of the wheels is starting to lock up, the system goes into ABS mode.

At the same moment as wheel lock-up begins, the pedal position sensor sends information to the control module on the position of the brake pedal.

If the brake pedal is depressed further, the hydraulic pump starts and builds up pressure which forces the pedal back to its original position, i.e. the position it had when the wheel started to lock up.

When braking is normal again and wheel lock-up no longer occurs, the system leaves ABS mode and returns to normal mode.

This sequence can occur several times during the same braking period.

ABS warning lamp

The control module monitors the function of the ABS system and lights ABS warning lamp 47Q (ANTI LOCK) if any of the functions is faulty. When the lamp is on, the ABS function is inoperative and the brake system functions as a conventional system.

If one of the following faults occurs, the lamp lights up because the control module ceases to ground it via pin 34. Main relay 292 then releases and the lamp is grounded to grounding point G15 via the relay contact and diode 303A:

- when the level of the signal from one of wheel sensors 298 is too low.
- When there is a fault in main relay 292.
- When there is a fault in the inlet and outlet valves in valve block 296.
- When there is a fault in the hydraulic pump.
- When there is an open circuit in the wiring harness (or in the connectors) connected to valve block 296, wheel sensors 298.
- When there is a fault in the control module.

Fault diagnosis

Scan tool diagnostics using the ISAT scan tool.

Readings:

Component	Rating	Remarks
298 Wheel sensor	800-1400 ohms min ~ 0.1 V	applicable when the wheel is rotating at 1 rev/s
296 Inlet valve	approx. 5-10 ohms	IFL, IFR, IRL, IRR
296 Outlet valve	approx. 3-5 ohms	OFL, OFR, ORL, ORR

Component locations

1	Battery in the engine bay.		<i>2-pin connectors</i>
22A	Fuse board behind the cover flap in the glove box.	H2-46	In the engine bay behind the bulkhead on the far left.
29	Brake light switch beside the brake pedal.	H2-47	In the engine bay behind the bulkhead on the far right.
47Q	ABS/ ABS-TCS warning lamp in the main instrument display panel	H2-48	Under the rear seat on the left-hand side under the carpet.
75	Distribution block, battery positive, on the battery tray.	H2-49	Under the rear seat on the right-hand side under the carpet.
159	Distribution terminal (+15 circuit) in main fuse box behind the glove box.	H10-17	<i>10-pin connector</i> On the valve block.
230	Distribution terminal (+30 circuit) in main fuse box behind the glove box.	G15	Grounding point, ABS, on the left-hand structural member, beside the ABS control module.
291	ABS control module on the battery tray.	G15	Grounding point beside the ABS control module.
292	Main relay, ABS, in main fuse box behind the battery.	G16	Grounding point on the left-hand structural member.
293	Pump relay, ABS, in main fuse box behind the battery.	G24	Grounding point, on the front right-hand seat member.
296	ABS valve block on the hydraulic unit.		
298A	Wheel sensor, front left-hand, on the left-hand steering swivel member.		
298B	Wheel sensor, front right-hand, on the right-hand steering swivel member.		
298C	Wheel sensor, rear left-hand, on the left-hand rear wheel hub.		
298D	Wheel sensor, rear right-hand, on the right-hand rear wheel hub.		
302A	Fuse board, ABS, in main fuse box behind the battery.		
303A/ 303B	Diode, ABS, under the relay board in the ABS main fuse box (302B).		
348 (H10-9)	Scan tool diagnostics data link connector under the right-hand seat.		
427	Motor, hydraulic pump (ABS/ABS-ASR MARK IV) on the hydraulic unit.		
428	Pedal position sensor (ABS/ABS-ASR MARK IV) on the brake vacuum servo.		

Components

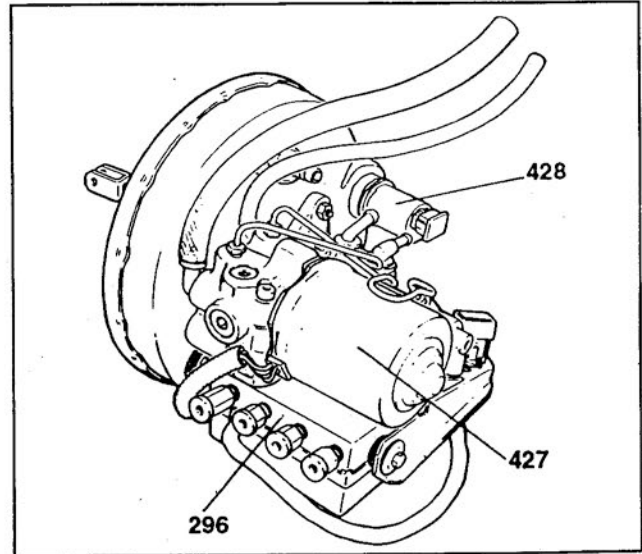
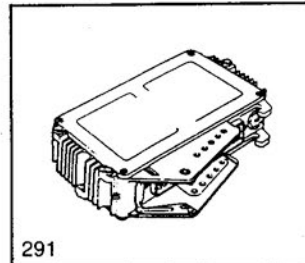
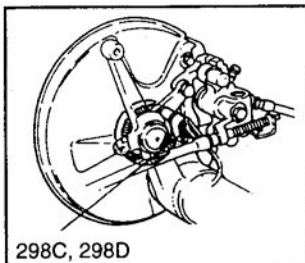
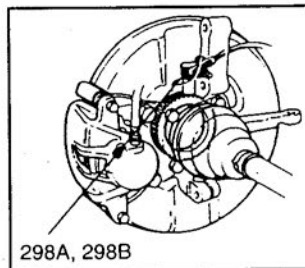
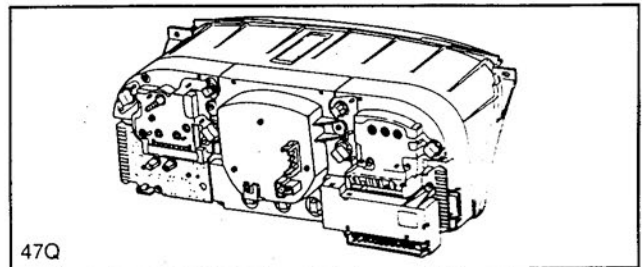
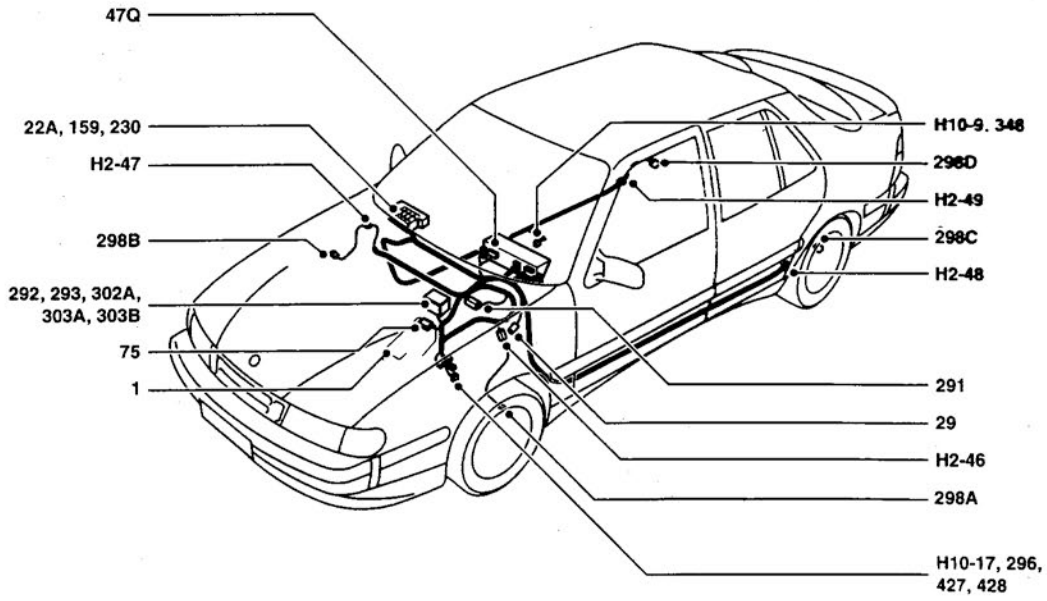

C521W-4565

Description of operation

A complete description can be found in Service Manual "2:5 Traction Control System TCS".

In the brake related part of the TCS system, the anti-lock brake system (Mark II) is the most important component. However, for the anti-spin function, an extra valve housing (TC block) has been added to the hydraulic unit. The system includes indicator and warning lamps.

The system receives data on the wheel speed via the wheel sensors. With the average speed of the rear wheels as a reference (used in the TCS mode), the control module can at any given moment control the degree of spin on one of the drive wheels (speed increase in relation to the rear wheels).

When wheelspin is about to happen and TCS control is about to take place, accumulator pressure is supplied through the TC block and the main valve to the front wheel circuits. Braking is then controlled using the inlet and outlet valves.

The components in the TC/ABS system are supplied with current via the fuses in relay and fuse board 302 in the engine bay on the bulkhead partition.

- Fuse 1 (30A) protects pump motor 297 (via relay 293).
- Fuse 2 (30A) protects control valves 295, 296 and 383 (via main relay 292).
- Fuse 3 (10A) protects control module 382.
- Warning lamps 47Q, 47Y and 47F as well as indicator lamp 47X receive current (+15 circuit) via fuse 13 when the ignition switch is in the Drive or Start position.

Power supply

When the ignition switch is turned to the Drive position, pin 53 of the control module is supplied with current (+54 circuit). The control module then grounds main relay 292 via pin 34, causing the relay to operate. The unit then receives current (+30 circuit) for operation of the hydraulic unit control valves.

Function of warning lamps when starting

Each time the car is started the brake system warning lamps light up to show the driver that they are intact and in working order. How the lamps light up in the event of a fault in the system is described in "monitoring functions" below.

When the ignition switch is turned to the Start position, current (+54 circuit) to main relay 292 is cut off, causing it to release. As a result, ABS warning lamp 47Q is grounded to grounding point G15 via diode 303A and the relay contact. At the same time, warning lamp 47Y is grounded to grounding point G15 via diodes 303A and 385 and the relay contact.

Since the relay is always deactivated for at least 2 seconds when starting, the lamp will light up during this time. However, the lamp can light up for up to 60 seconds until the correct hydraulic pressure has been reached. When the ignition switch is turned to the Start position, the test mode will also be passed on the switch. Brake warning lamp 47F will then be grounded through ignition switch 20 which causes the lamp to light up.

Hydraulic pressure

The pressure in the hydraulic unit's pressure accumulator is maintained at the correct level by means of a hydraulic pump driven by motor 297 and controlled by pressure and warning switch 294.

If the car is started when the pressure is below 140 bar, switch 4-1 will close. The coil in pump relay 293 is then grounded and motor 297 receives current via the relay contact.

When the hydraulic pump has pumped up the pressure in the pressure accumulator to 180 bar, the switch opens and the motor stops. When the pressure drops to 140 bar while the car is being driven, the switch closes again and the pump starts. The pump has to work for 10-15 seconds to raise the pressure from 140 to 180 bar.

Brake light switch

During braking, the brake light switch supplies data to the control module via pin 32. As a result, the system reacts more rapidly.

Control module 382

Control module 382 continuously receives data about the wheel speed from the four wheel speed sensors:

298A front left
298B front right
298C rear left
298D rear right

On the basis of incoming speed data from the sensors, the control module then regulates the braking force on the wheels via the six hydraulic valves 296 in the hydraulic unit.

Braking force on the front wheels is regulated individually and on the rear wheels jointly. Two valves, one inlet and one outlet, are provided for each function.

Left-hand front wheel:

IFL intake valve
OFL outlet valve

Right-hand front wheel:

IFR intake valve
OFR outlet valve

Rear wheels (common circuit):

IR intake valve
OR outlet valve

If no current is supplied, the inlet valves are open and the outlet valves closed.

Valve block 383

Valve block 383 contains two valves and a pressure sensor. The control module receives data from the pressure sensor when the brake is activated (contacts 2-3 open). The valves are supplied with battery positive voltage via pin 3 of the control module. To activate a valve, it is grounded via the control module.

Main valve 295 receives current and is open when the ABS system is in operation.

Pressure sensor in valve block 383

The control module receives data from the pressure sensor in the valve block about whether the brake is activated or not and whether the TC or ABS mode is in operation.

The signal from the pressure sensor is compared with the input signal from brake light switch 29.

TCS ON/OFF Switch 449

The TCS function can be turned off with switch 449. The speed of the car must be below 60 km/h. When the switch is depressed, test lamp 47Y lights up.

Monitoring functions

For the function of the lamps when starting, see above under "Function of warning lamps when starting".

Brake fluid level warning lamp

Brake warning lamp 47F lights up under the following circumstances:

- if the level in the brake fluid reservoir drops to the MIN mark, the lamp is grounded to grounding point G2 via contact 4-3 in level sensor 299.
- if the pressure in the hydraulic unit pressure accumulator drops below 105 bar, causing the lamp to be grounded to grounding point G2 via contact 2-1 in pressure and warning switch 294. The switch closes at 105 bar and opens at 134 bar. In this situation, the ABS warning lamp also lights up.

Both switches are normally open. The brake warning lamp is also fitted to cars without TC/ABS, but is then only used to warn the driver that the level of fluid in the brake fluid reservoir is getting low.

ABS and TCS CTRL warning lamp

The control module monitors the function of the TC/ABS system. If one of the functions is faulty, warning lamp 47Q (ANTI LOCK) lights up for the ABS system and TCS CTRL 47Y for the TC system. When the lamps are on, the ABS and TC functions are inoperative and the brake system functions as a conventional brake system.

Since control module 382 grounds the lamps via pins 52 and 44, the lamps light up if the following faults develop:

- if the level in the brake fluid reservoir drops below the MIN mark, contact 1-2 in level sensor 299 opens, breaking the connection between pins 51 and 8 of the control module. Contact 3-5 in pressure and warning switch 294 is normally closed. In this position, the brake warning lamp also lights up.
- if the pressure in the hydraulic unit pressure accumulator drops below 105 bar, causing contact 3-5 in pressure and warning switch 294 to open. Contact 1-2 in level sensor 299 is closed if the level in the brake fluid reservoir is correct. The brake warning lamp also lights up.
- when the level of the signal from one of wheel sensors 298 is too low.
- The lamps also light up in the event of a grounding fault, pins 1 and 19.

In the case of the following faults, the lamps light up because the control module no longer grounds via pin 34. Main relay 292 therefore releases and the lamps are grounded to grounding point G15 via the relay contact and diodes 303A and 385:

- open circuit in the wiring harness (or in the connectors) connected to valve block 296, wheel sensors 298 or main valve 295.
- a fault in the control module.

In the case of the following faults, only the TCS CTRL lamp lights by pin 44 being grounded to the control module.

- When there is a fault in the circuit to the brake light switch.
- When there is a fault in the circuit to the pressure switch in valve block 383. In the case of these faults, the TC has no effect on the brakes.
- If there is an open circuit, short circuit or incorrect level, pin 4 or 24. The TC system will not operate the throttle butterfly.
- If the front brake pads are overheated (temperature over 400 °C).

Important:

This fault will cause the lamp to flash. When the pads have cooled down (300 °C), the lamp goes out.

TCS indicator lamp

When the TC system is in operation, indicator lamp 47X lights by pin 7 being grounded to control module 382.

Fault diagnosis

The control module connectors are of splash-proof design which means that the connector pins are embedded in rubber.

This means that readings cannot be taken at the back of the connector when fault diagnosis is carried out. A "Breakout-box" should be used instead.

Scan tool diagnostics and fault diagnosis are described in detail in Service Manual "**2:5 Traction Control System**".

Component locations

1	Battery in the engine bay.	385	Diode, ABS/TC, under the relay board in the main fuse box behind the battery.
22A	Fuse board behind the cover flap in the glove box.	449	TCS ON/OFF switch in the dashboard.
29	Brake light switch beside the brake pedal. <i>in the main instrument display panel</i>		<i>2-pin connectors</i>
47F	Brake fluid level warning lamp	H2-46	In the engine bay behind the bulkhead on the far left.
47Q	ABS/ ABS-TCS warning lamp.	H2-47	In the engine bay behind the bulkhead on the far right.
47X	TCS (Antispinn) indicator lamp.	H2-48	Under the rear seat on the left-hand side under the carpet.
47Y	TCS CTRL warning lamp.	H2-49	Under the rear seat on the right-hand side under the carpet.
75	Distribution block, battery positive, on the battery tray.		
159	Distribution terminal (+15 circuit) in main fuse box behind the glove box.	G8	Grounding point, on the reinforcing member under the left-hand loudspeaker grille.
230	Distribution terminal (+30 circuit) in main fuse box behind the glove box.	G15	Grounding point, ABS, on the left-hand structural member beside the ABS control module.
292	Main relay, ABS, in main fuse box behind the battery.	G16	Grounding point on the left-hand structural member.
293	Pump relay, ABS, in main fuse box behind the battery. <i>on the hydraulic unit</i>	G24	Grounding point, right-hand front seat member.
294	ABS pressure switch.		
295	ABS Main valve.		
296	ABS valve block.		
297	ABS hydraulic pump motor.		
298A	Wheel sensor, front left-hand, on the left-hand steering swivel member.		
298B	Wheel sensor, front right-hand, on the right-hand steering swivel member.		
298C	Wheel sensor, rear left-hand, on the left-hand rear wheel hub.		
298D	Wheel sensor, rear right-hand, on the right-hand rear wheel hub.		
299	Brake fluid level sensor, ABS, on the hydraulic unit's brake fluid reservoir.		
302A	Fuse board, ABS, behind the battery.		
303A/ 303B	Diode, ABS, under the relay board in the main fuse box behind the battery.		
348 (H10-9)	Scan tool diagnostics data link connector under the right-hand seat.		
376	ETS control module, under left-hand front seat.		
382	ABS-TC control module on the battery tray.		
383	Valve block, ABS-TC, on the hydraulic unit.		

Components

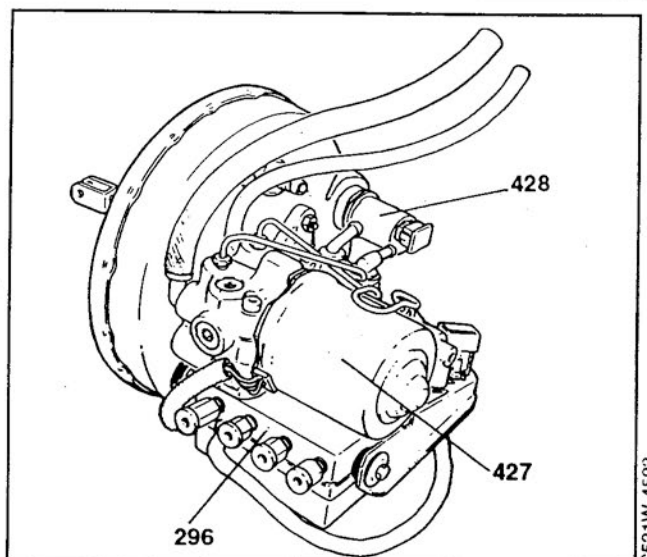
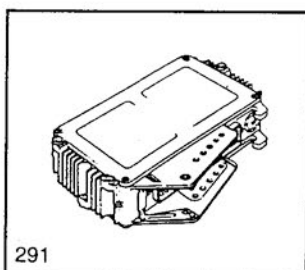
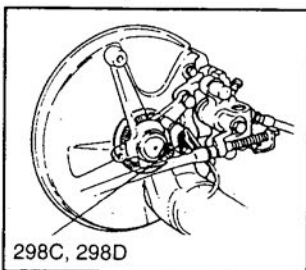
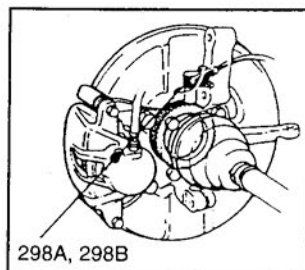
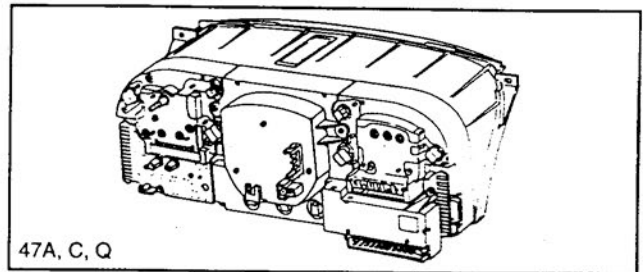
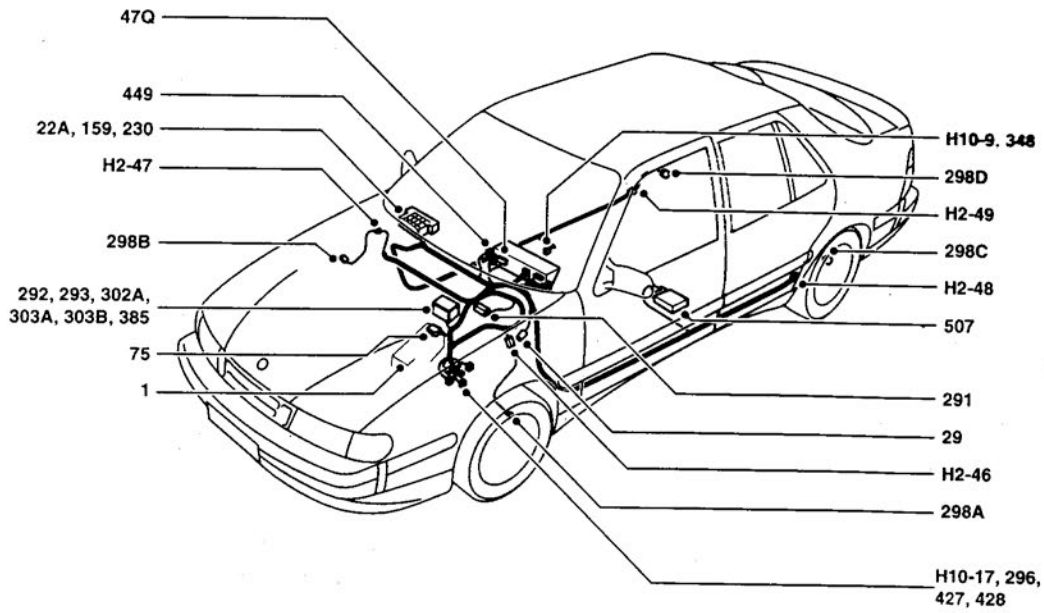

C521W-4593

SRS (Airbag)

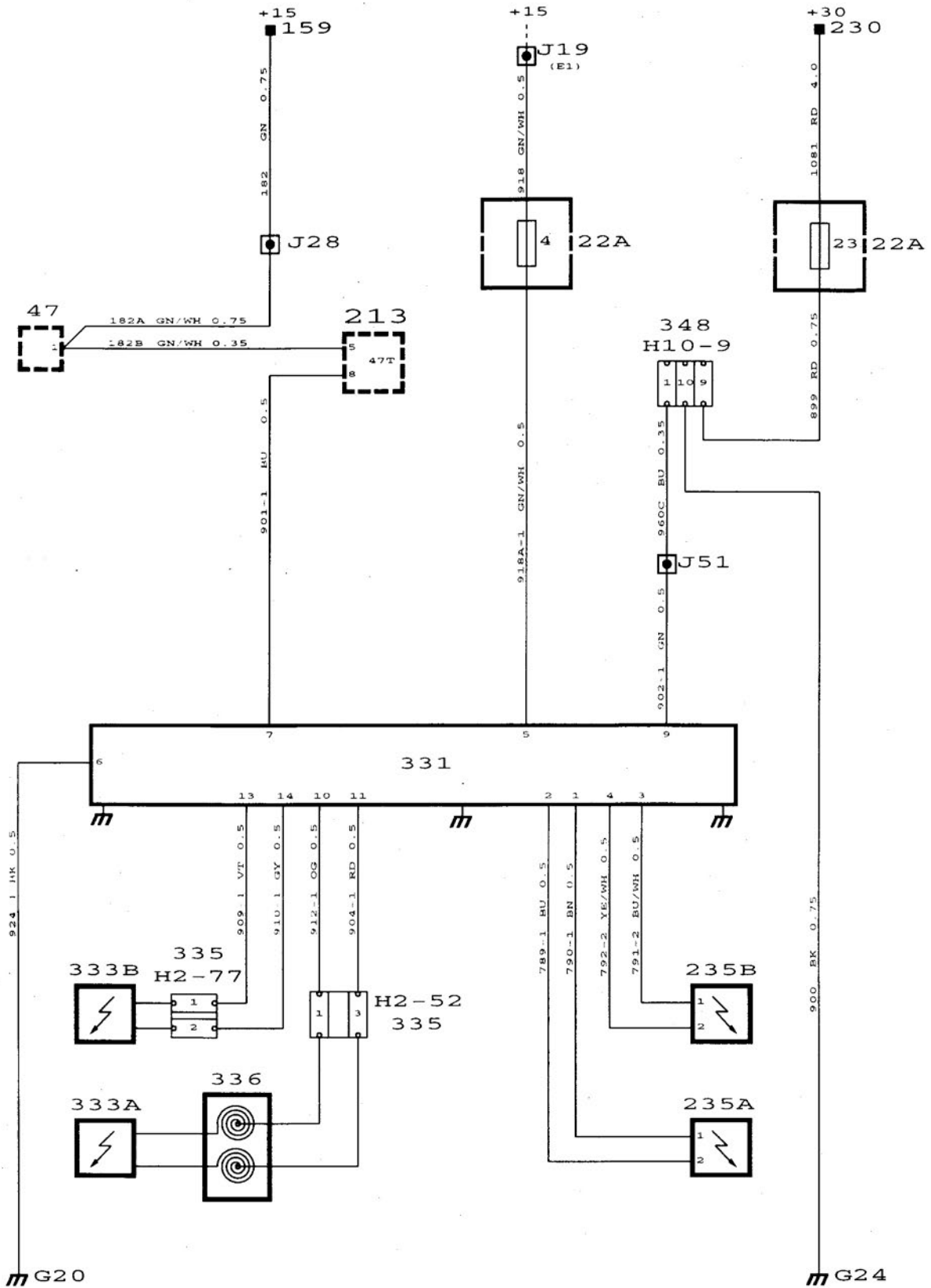

Description of operation

Cars equipped with an airbag have the marking SRS (Supplementary Restraint System) on the steering wheel pad.

The system consists of a control module, seat-belt tensioners, steering wheel pad and passenger pad, both with gas generator and airbag.

Airbag control module 331

The control module contains a microprocessor, electromechanical safety sensor, acceleration sensor and capacitors. Mounting of the unit is direction-dependent.

Airbag 333A

The steering wheel pad contains a gas generator and an airbag.

Airbag 333B

The passenger airbag is fitted where the glove box would otherwise be. It contains a gas generator and airbag.

Gas generator

The gas generator consists of a central chamber and two annular chambers.

There is an electric detonator and an explosive charge in the centre chamber, which is in communication with the inner annular chamber.

Seat-belt tensioners 235A and B

The seat-belt tensioners tension the two front seat-belts when the system is activated.

SRS warning lamp

If there is a fault in the system, warning lamp 47T is grounded via the control module.

Power supply

The control module is supplied with current via fuse 4.

Activating the airbags and seat-belt tensioners

In order for the airbags and seat-belt tensioners to activate, the sensors in the control module must sense the retardation.

Grounding

No grounding leads from other systems may be connected to the control module retaining bolts as operation of the system could be affected and a fault indication received from the diagnostic unit.

Fault diagnosis hints

Before starting fault diagnosis, the following points must always be followed:

- Read through the safety and handling instructions.
- Unplug the connectors on the back of the driver and passenger airbags.
- Connect reference resistor 84 71 153 to each connector.

Important:

Faulty SRS system components must **not** be repaired. Always discard them and fit new components.

SRS cables must **not** be spliced.

For scan tool diagnostics and fault diagnosis as well as operation, see Service Manual "8:6 Airbag".

Component locations

22A	Fuse board behind the cover flap in the glove box.
47T	Airbag warning lamp in pictogram 213.
159	Distribution terminal (+15 circuit) in main fuse box behind the glove box.
213	Pictogram, in the main instrument display panel.
235	Driver seat-belt tensioner, at the bottom of the B pillar on the driver's side.
235B	Passenger seat-belt tensioner, at the bottom of the B pillar on the passenger's side.
331	SRS control module, in front part of the centre console under the dashboard.
333A	Airbag, driver, in the steering wheel.
333B	Airbag, passenger, in the dashboard.
335 (H2-52)	Orange, short-circuiting connectors beside the steering wheel.
336	Contact unit, airbag (coil spring) on the steering column below the steering wheel.
348 (H10-9)	Scan tool diagnostics data link connector under the right-hand seat. <i>2-pin connector</i>
H2-72	Short-circuiting connector for passenger airbag.
G20	Grounding point, SRS, adjacent to the electronic unit.
G24	Grounding point, on the right-hand front seat member.

Components

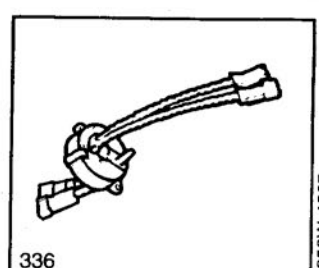
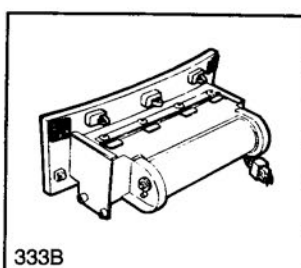
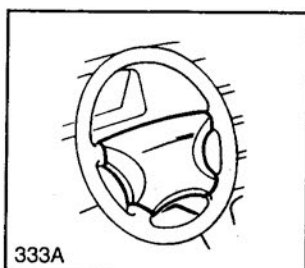
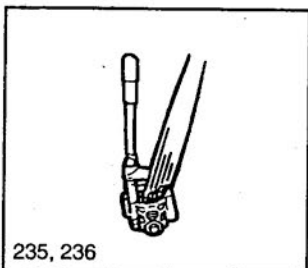
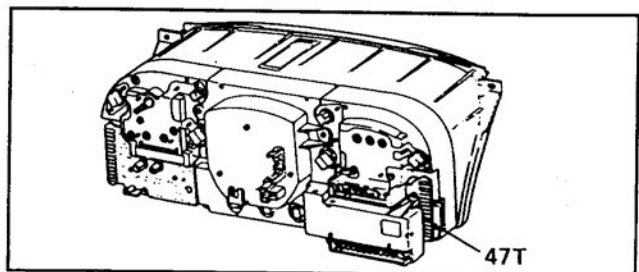
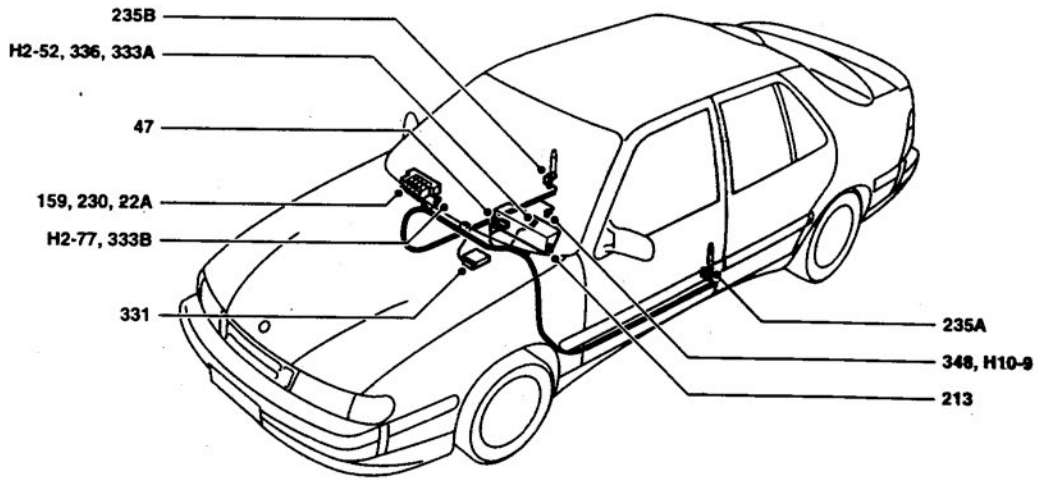

C853W-4567

Anti-theft alarm, other markets

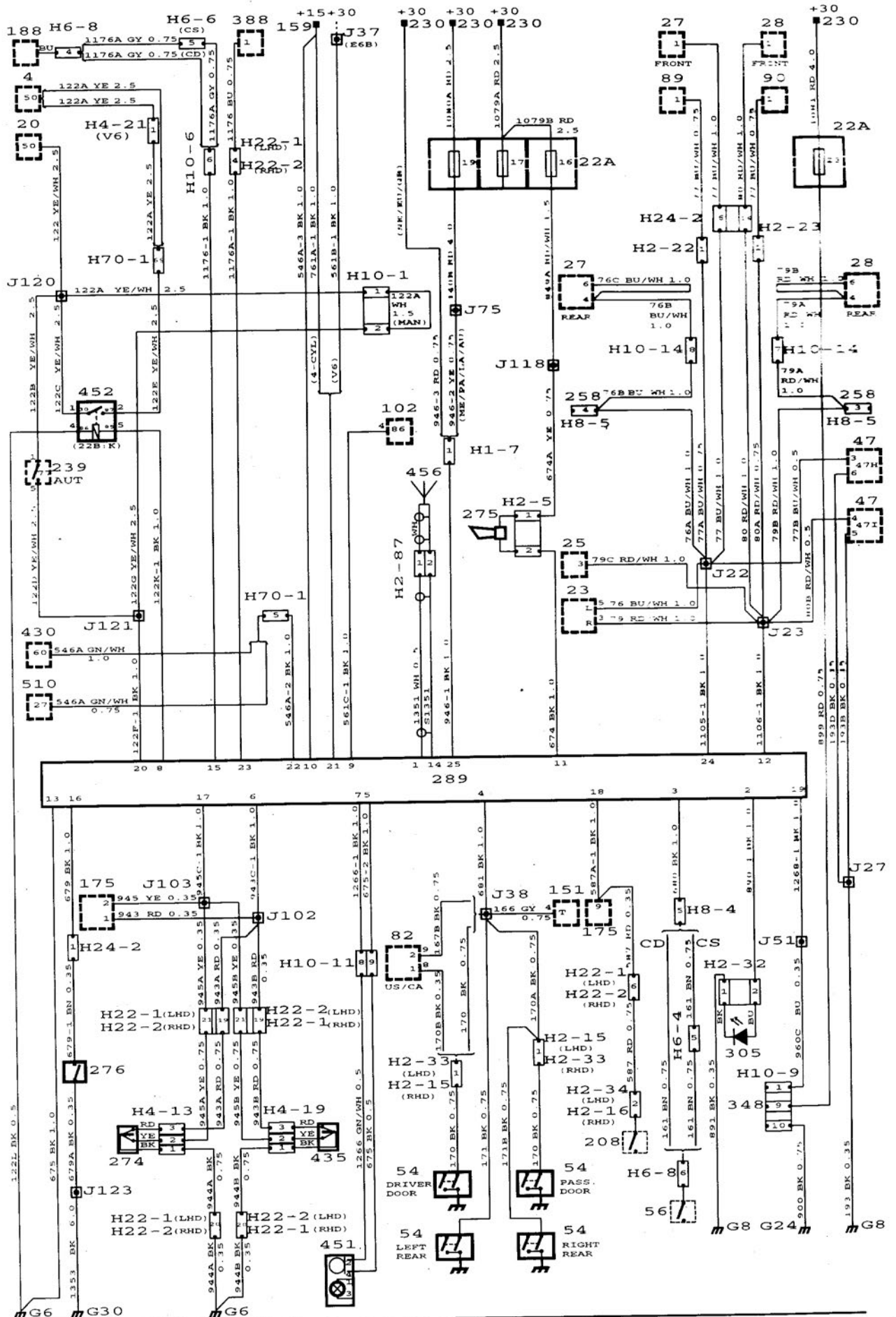

Saab 900

Description of operation

For information on anti-theft alarm operation and fault diagnosis, see Service Manual "3:5 Electrical system, anti-theft alarm".

Component locations

4	Starter motor on the left-hand side of the engine at the rear.	274	Microswitch, anti-theft alarm, beside the lock cylinder in the left-hand front door.
20	Ignition switch on the right of the steering wheel.	275	Siren, anti-theft alarm, in the left-hand front wing.
22A	Fuse board behind the cover flap in the glove box.	276	Bonnet switch, anti-theft alarm, in the front panel above the left-hand headlamp.
23	Flasher relay in main fuse box behind the glove box.	289	Control module, anti-theft alarm, on the right-hand side under the dashboard behind the knee shield.
25	Switch, hazard flashers, on dashboard adjacent to the central dashboard air vents.	305	LED, anti-theft alarm, on the dashboard beside the left-hand loud-speaker grille.
27	Direction indicator lamps, left-hand, in front and rear light clusters.	348	Data link connector, under the right-hand front seat.
28	Direction indicator lamps, right-hand, in front and rear light clusters.	H10-9	
47H	Indicator lamp, left-hand direction indicators, in the main instrument display panel.	430	Saab Trionic control module, in engine bay on the left behind the bulkhead partition.
47I	Indicator lamp, right-hand direction indicators, in the main instrument display panel.	435	Microswitch, anti-theft alarm, beside the lock cylinder in the right-hand front door.
54	Door switch, in each door pillar.	451	Glass breakage sensor, in front roof lamp.
56	Luggage compartment lighting switch, in the tailgate.	452	Starter interlock relay for anti-theft alarm, in main fuse box behind the glove box.
77	Starter motor interlock (automatic transmission) in transmission range switch 239 beside the gear selector.	456	Aerial for remote control, adjacent to the interior rearview mirror.
82	Relay, seat-belt/key warning, in the main fuse box behind the glove box.		
89	Side direction indicators, left, on the left-hand front wing.		
90	Side direction indicators, right, on the right-hand front wing.		
102	Relay, fuel pump, in the main fuse box behind the glove box.		
151	Time-delay relay, interior lighting, in main fuse box behind the glove box.		
159	Distribution terminal (+15 circuit) in main fuse box behind the glove box.		
175	Control module, central locking, on a bracket under the dashboard on the left-hand side.		
188	Motor, central locking system, in the tailgate.		
208	Switch, door indication, inside the locking mechanism in each door.		
230	Distribution terminal (+30 circuit) in main fuse box behind the glove box.		
239	Transmission range switch beside the selector lever.		

Continued on next page.

Continued from previous page.

	<i>2-pin connectors</i>		<i>24-pin connector</i>
H2-5	In the front left-hand corner of the engine bay under main fuse box 342.	H24-2	Behind the left-hand headlamp.
H2-15	In the right-hand A pillar.		<i>70-pin connector</i>
H2-16	Beside the locking mechanism inside the front right-hand door.	H70-1	In the engine bay, behind the bulkhead partition.
H2-22	Beside the left-hand side direction indicators.	G6	Grounding point, negative distribution terminal, in main fuse box 22B behind the glove box.
H2-23	Beside the right-hand side direction indicators.	G8	Grounding point, on the stiffening member under the left-hand loudspeaker grille.
H2-32	Adjacent to the LED beside the left-hand loudspeaker grille.	G24	Grounding point, on the right-hand front seat member.
H2-33	In the left-hand A pillar.	G30	Grounding point on the left-hand structural member behind the left-hand headlamp.
H2-34	Beside the locking mechanism inside the front left-hand door.		
H2-87	Adjacent to the interior rearview mirror.		
	<i>4-pin connectors</i>		
H4-13	In the left-hand front door beside the locking mechanism.		
H4-19	In the right-hand front door beside the locking mechanism.		
H4-21	Beside the generator (V6).		
	<i>6-pin connectors</i>		
H6-4	To the left in the tailgate beside the rear window.		
H6-6	To the right of the rear window wiper motor.		
H6-8	In the tailgate next to motor 188.		
	<i>8-pin connectors</i>		
H8-4	By the left-hand rear wheel housing.		
H8-5	Beside the left-hand rear light fitting.		
	<i>10-pin connectors</i>		
H10-1	Under the dashboard to the left of the heater housing.		
H10-6	Beside the left-hand rear wheel housing.		
H10-11	On the far left under the dashboard (behind the knee shield).		
H10-14	In the luggage compartment on the left-hand side, beside the filament monitor.		
	<i>22-pin connectors</i>		
H22-1	Behind the cable entry in the left-hand A pillar.		
H22-2	Behind the cable entry in the right-hand A pillar.		

Components

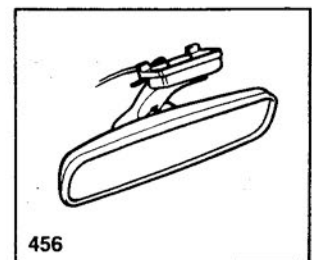
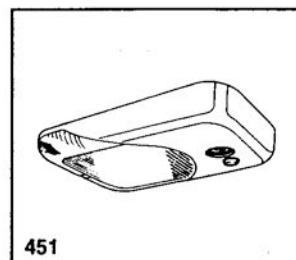
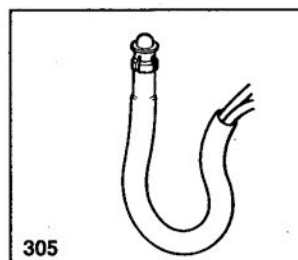
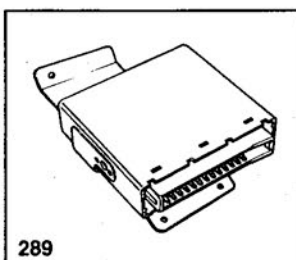
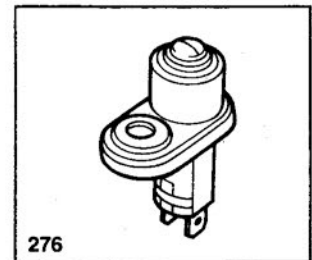
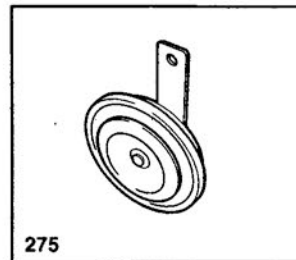
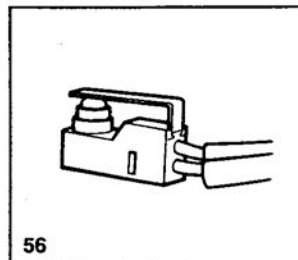
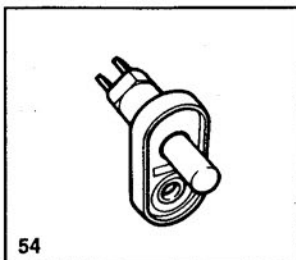
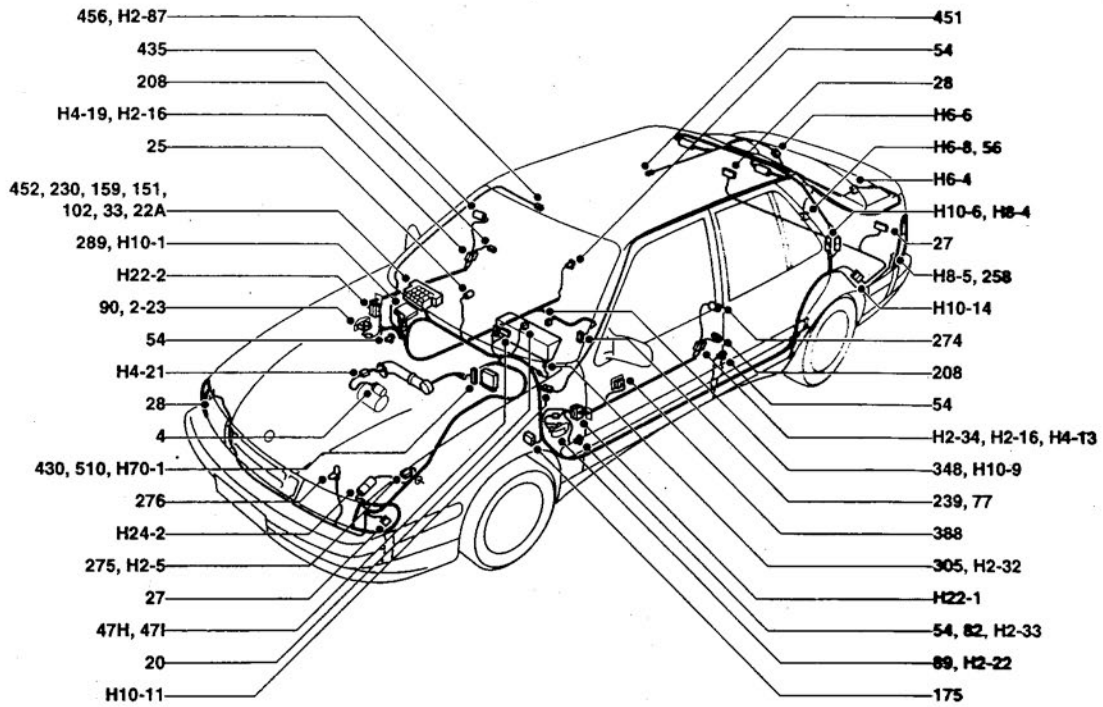

C383W-4568

Description of operation

In the US and CA markets, cars with automatic transmission have a SHIFT LOCK function which locks the transmission.

This entails the following:

- The ignition switch must be in the Drive position and the brake pedal depressed before the selector lever can be moved from the P position.
- The selector lever must be in the P position before the ignition key can be removed from the ignition switch.

When starting:

When the ignition switch is turned to the Start position, starter interlock relay is supplied with operating current on terminal 86 and the relay operates. When the brake pedal is then held depressed, solenoid 439 is grounded, which means that the solenoid no longer locks the P position and the selector lever can be moved.

When switching off:

When the ignition switch is turned to the OFF position, solenoid 438 in the ignition switch locks the ignition key so that it cannot be removed until the selector lever has been moved to the P position. Solenoid 438 is grounded when the selector lever is in the P position. As a result, the solenoid no longer locks the ignition key.

When the car is without current

Important:

Due to the power consumption, the car must not be left for long periods with the key in the ignition switch and the gear selector lever in any other position except P.

When the car is without current it will not be possible to move the selector lever out of the P position. For that reason, be sure not to move the selector to the P position if the car is without current.

Fault diagnosis hints

- 1 Check the connectors, wiring harness and ground connections.

When starting:

- 1 Check that fuse 1 is intact and supplied with current.
- 2 Check that current is supplied to starter interlock relay 437 and that the relay operates.
- 3 Check that current is supplied to the solenoid when the brake pedal is held down.

When switching off:

- 1 Check that fuse 27 is intact and supplied with current.
- 2 Check that current is supplied to solenoid 438 when the P position is selected.

Component locations

- 20 Ignition switch on the right of the steering wheel.
- 22A Fuse board behind the cover flap in the glove box.
- 29 Brake light switch beside the pedals.
- 437 Relay, starter motor interlock, in the main fuse box behind the glove box (22B:B1).
- 438 Ignition switch solenoid, beside the ignition switch.
- 439 Solenoid, selector lever, in the centre console beside the selector lever.
- 440 Microswitch, selector lever, in the gear lever console beside the P position.
2-pin connector
- H2-75 Beside the ignition switch.
4-pin connector
- H4-20 Beside the selector lever.
- G6 Grounding point, in the main fuse box behind the glove box.
- G24 Grounding point, right-hand seat member, under the right-hand front seat.

Components

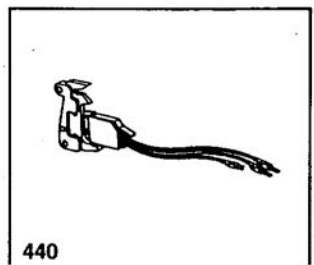
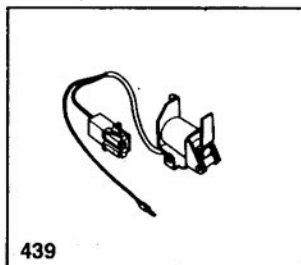
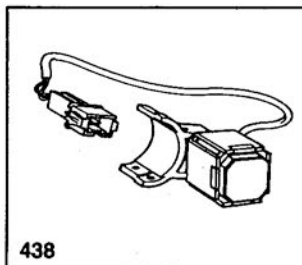
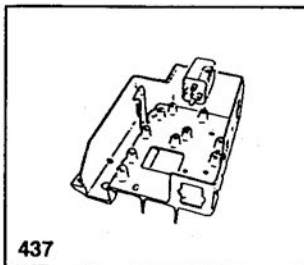
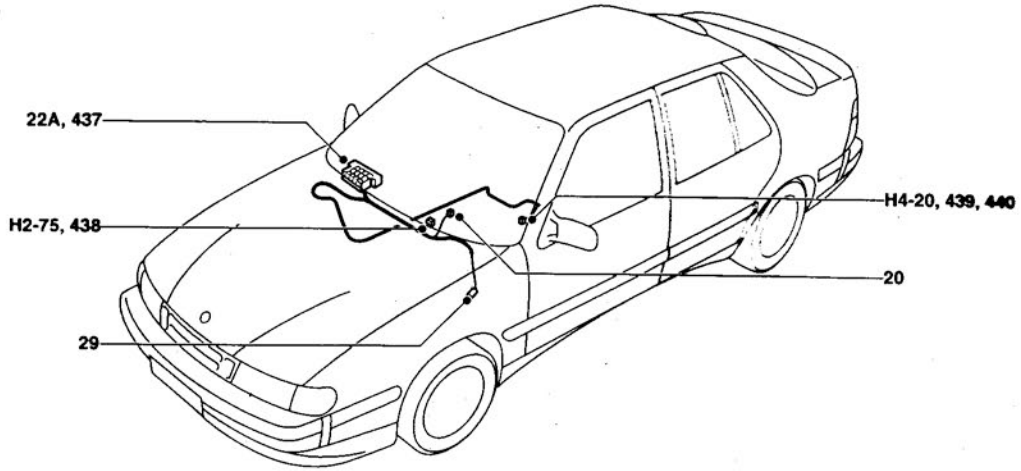

C444W-4569

List of components

Numerical index

1	Battery	47J	Indicator lamp, electrically heated rear window
2	Generator	47K	SHIFT UP indicator lamp
4	Starter motor	47L	EXH warning lamp
8	Lighting relay	47M	Handbrake warning lamp
10	Lights switch	47N	Rear fog light indicator lamp
11	Full beam	47Q	ABS/ABS-TCS warning lamp
12	Dipped beam	47R	Indicator lamp, washer fluid level.
13	Parking lights	47T	Airbag warning lamp
14	Rear lights	47U	Cruise Control system indicator lamp
15	Number plate lighting	47V	Lights-on indicator lamp
16	Rheostat, instrument lighting	47X	Indicator lamp, TCS
18	Instrument lighting	47Y	TCS CTRL warning lamp.
19	Glove box lamp	48	Cigarette lighter
20	Ignition switch	49	Clock
21	Ignition switch relay	50	Roof lamp, centre
22	Main fuse box, glove box	51	Roof lamp, front.
22A	Fuse board, glove box	53	Interior lighting switch
22B	Relay board, glove box	54	Door switches, interior lighting
23	Direction indicator relay	55	Luggage compartment lighting
24	Stalk switch, direction indicators	56	Luggage compartment light switch
25	Switch, hazard flashers	61	Stalk switch, windscreen wipers
27	Direction indicator lamps, left-hand	61A	Rear window wiper switch
28	Direction indicator lamps, right-hand	62	Windscreen wiper motor
29	Brake light switch	62A	Rear window wiper motor
30	Brake lights	63	Washer motor
31	Reversing-light switch.	64	Heating pad
32	Reversing lights	66	Headlamp wiper motor
33	Rear fog light	68	Horn relay
35	Ventilation fan selector switch	69	Seat switch, seat-belt warning lamp, passenger
36	Motor, ventilation fan	70	Driver's seat-belt switch
37	Motor, radiator fan	71	Passenger's seat-belt switch
38	Motor, recirculation flap.	72	Seat-belt warning lamp
40	Horn	74	Ventilation fan resistor
41	Horn switch	75	Distribution block, battery positive voltage
42	Brake fluid level warning switch	76	Switch, idling speed compensation, automatic
43	Handbrake switch	77	Starter motor interlock, automatic
44	Engine oil pressure sensor	78	Relay, dimmed dipped beam, together with main beam
45	Engine coolant temperature sensor	80	Resistor, dimmed dipped beam
46	Fuel level sensor	81	Two-speed radiator fan relay
47	Main instrument display panel	82	Seat-belt/ignition key warning relay
47A	Fuel gauge	83	Intermittent wiper operation relay
47B	Indicator lamp, fuel reserve	83A	Relay, intermittent wiper operation, rear window
47C	Coolant temperature gauge	85	Extra fog lights
47D	Warning lamp, oil pressure, in the pictogram	88	Switch, extra fog lights
47E	Charging indicator lamp.	89	Side direction indicator, left-hand
47F	Brake fluid level warning lamp	90	Side direction indicator, right-hand
47G	Full beam indicator lamp	91	Selector lever lighting
47H	Direction indicator repeater lamp, left-hand	102	Fuel pump relay
47I	Direction indicator repeater lamp, right-hand		

107	Relay, extra fog lights	191A	Switch, electric window lift, RH rear door
109	High-level brake light	193	Motor, electric window lift, LH rear door
110	Tachometer (rev counter)	194	Motor, electric window lift, RH rear door
111	Electronic speedometer	195	Washer fluid level switch
112	Sensor for electronic speedometer	198	Motor, recirculation flap, ACC
113	Electrically heated rear window relay	199	Motor, ventilation fan, ACC
115	Electrically heated rear window	202	Engine temperature sensor, engine management system
116	Electrically heated rear window switch	203	Throttle position sensor, engine management system, not ETS
119	Side reversing lights	206	Injectors, engine management system
124	Switch, electrically adjustable door mirrors	207	Heating element, electrically heated door mirrors
125	Left/right selector switch for the electrically adjustable door mirrors, driver/passenger side	208	Door indication
126	Motor, electrically adjustable door mirror, left-hand	209	Courtesy lights
127	Motor, electrically adjustable door mirror, right-hand	210	EDU trip computer (voltmeter, fuel consumption instrument)
132	Sensor, vehicle speed	213	Pictogram
133	Clutch switch, Cruise Control system	213A	Central lamp, pictogram
134	Brake switch, Cruise Control system	213B	Rear lights indication, pictogram
136	Oxygen sensor	213C	Front lights indication, pictogram
141	Selector, Cruise Control system	213D	Door indication, rear right-hand, pictogram
143	Recirculation switch, A/C	213E	Door indication, rear left-hand, pictogram
148	Front ashtray and cigarette lighter illumination	213F	Door indication, front right-hand, pictogram
149	Main switch, ventilation fan	213G	Door indication, front left-hand, pictogram
151	Time-delay relay, interior lighting	213H	Oil pressure warning lamp (47D), pictogram
154	Lighting, heater controls	213I	Airbag warning lamp (47T), pictogram
155	Relay, radiator fan, A/C	213J	Door indication, tailgate, pictogram
156	Relay, compressor, A/C	215	Dipswitch
157	Spark plugs	216	Climate control unit, ACC
159	Distribution terminal, +15 circuit	217	Blended air temperature sensor, ACC
160	Switch, glove box lighting	218	Inside air temperature sensor, ACC
161	Rear fog light switch	219	Suction fan, inside air temperature sensor, ACC
164	Motor, electric window lift, left-hand front door	220	Speed control, ventilation fan, ACC
165	Motor, electric window lift, right-hand front door	221	Motor, air distribution flap, ACC
166	Pressure switch, radiator fan, A/C	222	Motor, temperature flap, ACC
169	A/C switch	223	Solar sensor, ACC
170	Compressor, A/C	225	Reading lamp
171	Antifrost thermostat, A/C	226	Passenger lamp
172	Radiator fan, A/C	228A	Filament monitor, rear lamps
174	Relay, daylight driving lights	228B	Filament monitor, front lamps
175	Central locking system control module	229	Main relay, engine management system
178	Rear knock sensor	230	Distribution terminal, +30 circuit
178A	Front knock sensor	231	Distribution terminal, +54 circuit
179	Boost pressure control valve	232	Stepping relay, electrically operated sunroof
182	Motor, electric sunroof	234	Side marker lights
184	Motor, central locking system, front passenger door	235A	Seat-belt tensioner, driver
185	Motor, central locking system, right-hand rear door	235B	Seat-belt tensioner, passenger
186	Motor, central locking system, left-hand rear door	239	Transmission range switch, automatic transmission
188	Motor, central locking system, tailgate	241	SCC trip computer
190A	Switch, electric window lift, LH rear door	242	EDU coolant level switch

245	Transmission range switch, automatic transmission, EDU	333A	Airbag, driver
247	Fan, left-hand rear door, ACC	333B	Airbag, passenger
248	Fan, right-hand rear door, ACC	335	Airbag connector, 2-pin
252	Rheostat, heating pad, driver's seat	336	Slip-ring contact (coil spring), airbag
253	Rheostat, heating pad, passenger's seat	342	Main fuse box, engine bay
254	Temperature sensor, heating pad, driver's seat	342A	Fuse board, engine bay
255	Temperature sensor, heating pad, passenger's seat	342B	Relay board, engine bay
256	Buzzer, speed warning	345	Crankshaft position sensor
258	Connector, trailer lighting	346	Ignition discharge module
265	Motorized aerial	348	Data link connector, diagnostic
266	Connector for loudspeakers	349	Amplifier unit for radio
267	Radio connectors	350	Unit for CD player/equalizer
269	Multilead connector, 2-pole	351	Amplifier, audio
271	Oxygen sensor, preheating element	353	Radio — Cassette player, audio system
272	Motor, idling speed compensation, engine management system, not ETS	354	Amplifier, audio system
274	Microswitch in driver's door, anti-theft alarm	355	CD changer
275	Siren, anti-theft alarm	356	Speed warning control module
276	Bonnet switch, anti-theft alarm	357	Switch for electrically adjustable driver's seat
280	Motor, headlamp beam adjustment, left-hand	357A	Motor, fore-and-aft adjustment, electrically adjustable driver's seat
281	Motor, headlamp beam adjustment, right-hand	357B	Motor, front height adjustment, electrically adjustable driver's seat
282	Headlamp beam adjustment switch	357C	Motor, rear height adjustment, electrically adjustable driver's seat
286	Outside temperature sensor, EDU / SCC	357D	Motor, backrest rake adjustment, electrically adjustable driver's seat
289	Control module, anti-theft alarm	357E	Sensor, fore-and-aft adjustment, electrically adjustable driver's seat
291	Control module, ABS	357F	Sensor, front height adjustment, electrically adjustable driver's seat
292	Main relay, ABS, TC-ABS	357G	Sensor, rear height adjustment, electrically adjustable driver's seat
293	Pump relay, ABS, TC-ABS	357H	Sensor, backrest adjustment, electrically adjustable driver's seat
294	Pressure switch, TC-ABS	357J	Switch, electrically adjustable driver's seat
295	Main valve, TC-ABS	357K	Control module, electrically adjustable driver's seat with memory
296	Valve block, ABS, TC-ABS	358	Switch, electrically adjustable passenger's seat
297	Motor, hydraulic pump, TC-ABS	358A	Motor, fore-and-aft adjustment, electrically adjustable passenger's seat
298A	Speed sensor, left-hand front wheel, ABS, TC-ABS	358B	Motor, front height adjustment, electrically adjustable passenger's seat
298B	Speed sensor, right-hand front wheel, ABS, TC-ABS	358C	Motor, rear height adjustment, electrically adjustable passenger's seat
298C	Speed sensor, left-hand rear wheel, ABS, TC-ABS	358D	Motor, backrest rake adjustment, electrically adjustable passenger's seat
298D	Speed sensor, right-hand rear wheel, ABS, TC-ABS	359	Vanity mirror, left-hand
299	Brake fluid level sensor, TC-ABS	360	Vanity mirror, right-hand
302	Main fuse box, ABS, TC-ABS	366	Motor, 2-speed radiator fan
302A	Fuse board, ABS, TC-ABS	367	Resistor, 2-speed radiator fan
302B	Relay board, ABS, TC-ABS	369	Microswitch, seat backrest, electrically adjustable seat
303A	Diode, ABS, TC-ABS	373	Main switch, vanity mirror, left-hand
303B	Diode, ABS, TC-ABS	374	Main switch, vanity mirror, right-hand
305	LED, anti-theft alarm	375	Connector for mobile telephone
321	EVAP canister purge valve		
323	Fuel pump with integrated feeder pump		
324	Relay, secondary air injection pump		
325	Secondary air injection control valve		
326	Secondary air injection pump		
331	Airbag control module		

376	Electronic unit, ETS	G2	Grounding point, battery tray
377	Main relay, ETS	G3	Grounding point, luggage compartment
378	Motor, ETS	G4	Grounding point, tailgate, CS
379	Accelerator position sensor, ETS	G5	Grounding point, rear seat
380	Dump valve, ETS	G6	Distribution terminal, negative
381	By-pass valve, ETS	G7	Grounding point, engine
382	Control module, TC-ABS	G8	Grounding point, dashboard
383	Valve block, TC-ABS	G14	Grounding point, front left-hand seat member
385	Diode, TC-ABS	G15	Grounding point, ABS/TC-ABS control module beside Saab Trionic control module
386	Switch, electric window lifts/electric sunroof	G16	Grounding point, ABS/TC-ABS, on the left-hand structural member
388	Switch, tailgate release	G20	Grounding point, airbag control module
405	Reversing light relay	G24	Grounding point, front right-hand seat member
407	Engine temperature sensor	G25	Grounding point, gearbox
416	Relay, EXH warning	G26	Grounding point, right-hand C pillar
417	Temperature sensor, EXH	G27	Grounding point, motorized aerial
418	Reversing light fitting, CS	G29	Grounding point, right-hand rear light
419	Pressure switch, A/C	G30	Grounding point, left-hand structural member, behind the left-hand headlamp
427	Motor, hydraulic pump, ABS	G31	Grounding point, right-hand structural member, behind the right-hand headlamp
428	Position sensor, accelerator, ABS		
430	Control module, Saab Trionic engine management system		
431	Pressure sensor, Saab Trionic		
432	Relay, rear window washer		
433	Relay, radiator fan switch-off		
434	Central locking, fuel filler flap		
435	Microswitch, passenger's door		
436	Motor, central locking system, driver's door		
437	Relay, SHIFT LOCK starter motor interlock		
438	Solenoid, ignition switch		
439	Solenoid, selector lever		
440	Microswitch, selector lever		
444	Saab Trionic data link connector (for production only)		
446	Relay, electrically adjustable front seat, ignition switch		
447	Relay, electrically adjustable front seat, door switch		
449	TCS ON/OFF switch		
450	Actuator motor, TTS		
451	Glass breakage sensor		
452	Relay, anti-theft alarm starter motor interlock		
453	Pump, coolant circulation V6		
454	Control valve, inner VIM flap		
455	Control valve, outer VIM flap		
456	Aerial, anti-theft alarm remote control		
507	Control module, TTS		
508	Cruise Control system control module		
510	Control module, Motronic 2.8.1		
514A	Switch, simultaneous operation of central locking system (in 386)		
515	Rear oxygen sensor		
552	Ignition coil module		
555	Camshaft position sensor		

Alphabetical index

A/C switch	169	Data link connector, diagnostic	348
ABS/ABS-TCS warning lamp	47Q	Diode, ABS, TC-ABS	303A
Accelerator position sensor, ETS	379	Diode, ABS, TC-ABS	303B
Actuator motor, TTS	450	Diode, TC-ABS	385
Aerial, anti-theft alarm remote control	456	Dipped beam	12
Airbag connector, 2-pin	335	Dipswitch	215
Airbag control module	331	Direction indicator lamps, left-hand	27
Airbag warning lamp (47T), pictogram	213I	Direction indicator lamps, right-hand	28
Airbag warning lamp	47T	Direction indicator relay	23
Airbag, driver	333A	Direction indicator repeater lamp, left-hand	47H
Airbag, passenger	333B	Direction indicator repeater lamp, right-hand	47I
Amplifier unit for radio	349	Distribution block, battery positive voltage	75
Amplifier, audio system	354	Distribution terminal, +15 circuit	159
Amplifier, audio	351	Distribution terminal, +30 circuit	230
Antifrost thermostat, A/C	171	Distribution terminal, +54 circuit	231
Battery	1	Distribution terminal, negative	G6
Blended air temperature sensor, ACC	217	Door indication, front left-hand, pictogram	213G
Bonnet switch, anti-theft alarm	276	Door indication, front right-hand, pictogram	213F
Boost pressure control valve	179	Door indication, rear left-hand, pictogram	213E
Brake fluid level sensor, TC-ABS	299	Door indication, rear right-hand, pictogram	213D
Brake fluid level warning lamp	47F	Door indication, tailgate, pictogram	213J
Brake fluid level warning switch	42	Door indication	209
Brake light switch	29	Courtesy lights	208
Brake lights	30	Door switches, interior lighting	54
Brake switch, Cruise Control system	134	Driver's seat-belt switch	70
Buzzer, speed warning	256	Dump valve, ETS	380
By-pass valve, ETS	381	EDU coolant level switch	242
Camshaft position sensor	555	EDU trip computer (voltmeter, fuel consumption instrument)	210
CD changer	355	Electrically heated rear window relay	115
Central lamp, pictogram	213A	Electrically heated rear window	113
Rear lights indication, pictogram	213B	Electrically heated rear window switch	116
Central locking system control module	175	Electronic speedometer	111
Central locking, fuel filler flap	434	Electronic unit, ETS	376
Charging indicator lamp	47E	Engine coolant temperature sensor	45
Cigarette lighter	48	Engine oil pressure sensor	44
Climate control unit, ACC	216	Engine temperature sensor, engine management system	202
Clock	49	Engine temperature sensor	407
Clutch switch, Cruise Control system	133	EVAP canister purge valve	321
Compressor, A/C	170	Extra fog lights	85
Connector for loudspeakers	266	Fan, left-hand rear door, ACC	247
Connector for mobile telephone	375	Fan, right-hand rear door, ACC	248
Connector, trailer lighting	258	Filament monitor, front lamps	228B
Control module, ABS	291	Filament monitor, rear lamps	228A
Control module, anti-theft alarm	289	Front ashtray and cigarette lighter illumination	148
Control module, Motronic 2.8.1	510	Front knock sensor	178A
Control module, Saab Trionic engine management system	430		
Control module, TC-ABS	382		
Control module, TTS	507		
Control valve, inner VIM flap	454		
Control valve, outer VIM flap	455		
Coolant temperature gauge	47C		
Crankshaft position sensor	345		
Cruise Control system control module	508		
Cruise Control system indicator lamp	47U		

Front lights indication, pictogram	213C	Ignition switch relay	21
Fuel gauge	47A	Ignition switch	20
Fuel level sensor	46	Indicator lamp, electrically heated rear window	47J
Fuel pump relay	102	Indicator lamp, fuel reserve	47B
Fuel pump with integrated feeder pump	323	Indicator lamp, TCS	47X
Full beam indicator lamp	47G	Indicator lamp, washer fluid level.	47R
Full beam	11	Injectors, engine management system	206
Fuse board, ABS, TC-ABS	302A	Inside air temperature sensor, ACC	218
Fuse board, engine bay	342A	Instrument lighting	18
Fuse board, glove box	22A	Interior lighting switch	53
Generator	2	Intermittent wiper operation relay	83
Glass breakage sensor	451	LED, anti-theft alarm	305
Glove box lamp	19	Left/right selector switch for the electrically adjustable door mirrors, driver/passenger side	125
Grounding point, ABS/TC-ABS control module beside Saab Trionic control module	G15	Lighting relay	8
Grounding point, ABS/TC-ABS, on the left-hand structural member	G16	Lighting, heater controls	154
Grounding point, airbag control module	G20	Lights switch	10
Grounding point, battery tray	G2	Lights-on indicator lamp	47V
Grounding point, dashboard	G8	Luggage compartment light switch	56
Grounding point, engine	G7	Luggage compartment lighting	55
Grounding point, front left-hand seat member	G14	Main fuse box, ABS, TC-ABS	302
Grounding point, front right-hand seat member	G24	Main fuse box, engine bay	342
Grounding point, gearbox	G25	Main fuse box, glove box	22
Grounding point, left-hand structural member, behind the left-hand headlamp	G30	Main instrument display panel	47
Grounding point, luggage compartment	G3	Main relay, ABS, TC-ABS	292
Grounding point, motorized aerial	G27	Main relay, engine management system	229
Grounding point, rear seat	G5	Main relay, ETS	377
Grounding point, right-hand C pillar	G26	Main switch, vanity mirror, left-hand	373
Grounding point, right-hand rear light	G29	Main switch, vanity mirror, right-hand	374
Grounding point, right-hand structural member, behind the right-hand headlamp	G31	Main switch, ventilation fan	149
Grounding point, tailgate, CS	G4	Main valve, TC-ABS	295
Handbrake switch	43	Microswitch in driver's door, anti-theft alarm	275
Handbrake warning lamp	47M	Siren, anti-theft alarm	274
Rear fog light indicator lamp	47N	Microswitch, passenger's door	435
Headlamp beam adjustment switch	282	Microswitch, seat backrest, electrically adjustable seat	369
Outside temperature sensor, EDU / SCC	286	Microswitch, selector lever	440
Headlamp wiper motor	66	Motor, 2-speed radiator fan	366
Heating element, electrically heated door mirrors	207	Motor, air distribution flap, ACC	221
Heating pad	64	Motor, backrest rake adjustment, electrically adjustable passenger's seat	358D
High-level brake light	109	Motor, central locking system, driver's door	436
Horn relay	68	Motor, central locking system, front passenger door	184
Horn switch	41	Motor, central locking system, left-hand rear door	186
Horn	40	Motor, central locking system, right-hand rear door	185
Ignition coil module	552	Motor, central locking system, tailgate	188
Ignition discharge module	346	Motor, electric sunroof	182

Motor, electric window lift, left-hand front door	164	Pressure switch, radiator fan, A/C	166
Motor, electric window lift, LH rear door	193	Pressure switch, TC-ABS	294
Motor, electric window lift, RH rear door	194	Pump relay, ABS, TC-ABS	293
Motor, electric window lift, right-hand front door	165	Pump, coolant circulation V6	453
Motor, electrically adjustable door mirror, left-hand	126	Radiator fan, A/C	172
Motor, electrically adjustable door mirror, right-hand	127	Radio connectors	267
Motor, ETS	378	Radio — Cassette player, audio system	353
Motor, fore-and-aft adjustment, electrically adjustable driver's seat	357A	Reading lamp	225
Motor, fore-and-aft adjustment, electrically adjustable passenger's seat	358A	Rear fog light switch	161
Motor, front height adjustment, electrically adjustable driver's seat	357B	Rear fog light	33
Motor, front height adjustment, electrically adjustable passenger's seat	358B	Rear knock sensor	178
Motor, headlamp beam adjustment, left-hand	280	Rear lights	14
Motor, headlamp beam adjustment, right-hand	281	Rear oxygen sensor	515
Motor, hydraulic pump, ABS	427	Rear window wiper motor	62A
Motor, hydraulic pump, TC-ABS	297	Rear window wiper switch	61A
Motor, idling speed compensation, engine management system, not ETS	272	Recirculation switch, A/C	143
Motor, radiator fan	37	Relay board, ABS, TC-ABS	302B
Motor, rear height adjustment, electrically adjustable driver's seat	357D	Relay board, engine bay	342B
Motor, backrest rake adjustment, electrically adjustable driver's seat	357C	Relay board, glove box	22B
Motor, rear height adjustment, electrically adjustable passenger's seat	358C	Relay, anti-theft alarm starter motor interlock	452
Motor, recirculation flap, ACC	198	Relay, compressor, A/C	156
Motor, recirculation flap.	38	Relay, daylight driving lights	174
Motor, temperature flap, ACC	222	Relay, dimmed dipped beam, together with main beam	78
Motor, ventilation fan, ACC	199	Relay, electrically adjustable front seat, ignition switch	447
Motor, ventilation fan	36	Relay, electrically adjustable front seat, door switch	446
Motorized aerial	265	Relay, EXH warning	416
Multilead connector, 2-pole	269	Relay, extra fog lights	107
Number plate lighting	15	Relay, intermittent wiper operation, rear window	83A
Oil pressure warning lamp (47D), pictogram	213H	Relay, radiator fan switch-off	433
Oxygen sensor, preheating element	271	Relay, radiator fan, A/C	155
Oxygen sensor	136	Relay, rear window washer	432
Parking lights	13	Relay, secondary air injection pump	324
Passenger lamp	226	Relay, SHIFT LOCK starter motor interlock	437
Passenger's seat-belt switch	71	Resistor, 2-speed radiator fan	367
Pictogram	213	Resistor, dimmed dipped beam	80
Position sensor, accelerator, ABS	428	Reversing light fitting, CS	418
Pressure sensor, Saab Trionic	431	Reversing light relay	405
Pressure switch, A/C	419	Reversing lights	32
		Reversing-light switch.	31
		Rheostat, heating pad, driver's seat	252
		Rheostat, heating pad, passenger's seat	253
		Rheostat, instrument lighting	16
		Roof lamp, centre	50
		Roof lamp, front.	51
		Saab Trionic data link connector (for production only)	444
		SCC trip computer	241
		Seat switch, seat-belt warning lamp, passenger	69
		Seat-belt tensioner, driver	235A

Seat-belt tensioner, passenger	235B	Control module, electrically adjustable driver's seat with memory	357K
Seat-belt warning lamp	72	Switch, electrically adjustable passenger's seat	358
Seat-belt/ignition key warning relay	82	Switch, extra fog lights	88
Secondary air injection control valve	325	Switch, glove box lighting	160
Secondary air injection pump	326	Switch, hazard flashers	25
Selector lever lighting	91	Switch, idling speed compensation, automatic	76
Selector, Cruise Control system	141	Switch, simultaneous operation of central locking system (in 386)	514A
Sensor for electronic speedometer	112	Switch, tailgate release	388
Sensor, backrest adjustment, electrically adjustable driver's seat	357H	Tachometer (rev counter)	110
Sensor, fore-and-aft adjustment, electrically adjustable driver's seat	357E	TCS CTRL warning lamp.	47Y
Sensor, front height adjustment, electrically adjustable driver's seat	357F	TCS ON/OFF switch	449
Sensor, rear height adjustment, electrically adjustable driver's seat	357G	Temperature sensor, EXH	417
Sensor, vehicle speed	132	Temperature sensor, heating pad, driver's seat	254
SHIFT UP indicator lamp	47L	Temperature sensor, heating pad, passenger's seat	255
EXH warning lamp	47K	Throttle position sensor, engine management system, not ETS	203
Side direction indicator, left-hand	89	Time-delay relay, interior lighting	151
Side direction indicator, right-hand	90	Transmission range switch, automatic transmission, EDU	245
Side marker lights	234	Transmission range switch, automatic transmission	239
Side reversing lights	119	Two-speed radiator fan relay	81
Switch, electrically adjustable door mirrors	124	Unit for CD player/equalizer	350
Slip-ring contact (coil spring), airbag	336	Valve block, ABS, TC-ABS	296
Solar sensor, ACC	223	Valve block, TC-ABS	383
Solenoid, ignition switch	438	Vanity mirror, left-hand	359
Solenoid, selector lever	439	Vanity mirror, right-hand	360
Spark plugs	157	Ventilation fan resistor	74
Speed control, ventilation fan, ACC	220	Ventilation fan selector switch	35
Speed sensor, left-hand front wheel, ABS, TC-ABS	298A	Warning lamp, oil pressure, in the pictogram	47D
Speed sensor, left-hand rear wheel, ABS, TC-ABS	298C	Washer fluid level switch	195
Speed sensor, right-hand front wheel, ABS, TC-ABS	298B	Washer motor	63
Speed sensor, right-hand rear wheel, ABS, TC-ABS	298D	Windscreen wiper motor	62
Speed warning control module	356		
Stalk switch, direction indicators	24		
Stalk switch, windscreen wipers	61		
Starter motor interlock, automatic	77		
Starter motor	4		
Stepping relay, electrically operated sunroof	232		
Suction fan, inside air temperature sensor, ACC	219		
Switch for electrically adjustable driver's seat	357		
Switch, electric window lift, LH rear door	190A		
Switch, electric window lift, RH rear door	191A		
Switch, electric window lifts/electric sunroof	386		
Switch, electrically adjustable driver's seat	357J		

Crimped connection locations

J1		Approx. 150 mm from RH foglight switch, towards the LH side of car (front wiring harness).	J21	LHD	Approx. 150 mm from the pre-wired mobile telephone connection, towards the instrument (main wiring harness).
J5		Approx. 170 mm from LH foglight switch, towards the RH side of car (front wiring harness).		RHD	Approx. 140 mm from the branch to the radio connectors, towards the RH side of car (main wiring harness).
J7		Approx. 250 mm from RH foglight switch, towards LH side of car (front wiring harness).	J22	LHD	Approx. 250 mm from the brake lights switch, towards the centre console (main wiring harness).
J8		Approx. 210 mm from LH foglight switch, towards connector H24-2 (front wiring harness).		RHD	Approx. 40 mm from the branch to the radio connectors, towards the main fuse box (main wiring harness).
J14		Approx. 50 mm from branch to fan motor/resistor, towards connector H70-1 (main wiring harness).	J23	LHD	Approx. 220 mm from the brake lights switch, towards the centre console (main wiring harness).
J15		Approx. 150 mm from RH foglight switch, towards the LH side of car (front wiring harness).		RHD	Approx. 60 mm from the branch to the radio connectors, towards the main fuse box (main wiring harness).
J17		Approx. 330 mm from LH foglight switch, towards the RH side of car, (front wiring harness).	J24	LHD	Approx. 400 mm from the selector switch for the lights, headlight beam adjustment, rheostat, fog lights and rear fog light (main wiring harness).
J18	LHD	Approx. 170 mm from the cable entry in the bulkhead towards the ignition switch (main wiring harness).		RHD	Approx. 350 mm from the selector switch for the lights, headlight beam adjustment, rheostat, fog lights and rear fog light (main wiring harness).
	RHD	Approx. 110 mm from branch to radio switches, towards RH side of car (main wiring harness).	J25	LHD	Approx. 430 mm from the cable tie on the connector for the EDU (main wiring harness)
J19	LHD	Approx. 180 mm from the ignition switch and approx. 260 mm from the switch for the windscreen and rear window wipers (main wiring harness).		RHD	Approx. 245 mm from the cable tie on the connector for the EDU (main wiring harness).
	RHD	Approx. 260 mm from the ignition switch (main wiring harness).	J26	LHD	Approx. 200 mm from the brake lights switch, towards the branch to the LH front door (main wiring harness).
J20	LHD	Approx. 220 mm from the pre-wired mobile telephone connection, towards the main fuse box in the dashboard (main wiring harness).		RHD	Approx. 140 mm from the branch to the radio connectors, towards the RH side of car (main wiring harness).
	RHD	Approx. 20 mm from the branch to the radio connectors, towards the main fuse box (main wiring harness).	J27	LHD	Approx. 330 mm from the cable tie on the connector for the EDU (main wiring harness).
				RHD	Approx. 210 mm from the cable tie on the connector for the EDU (main wiring harness).

J28	LHD	Approx. 280 mm from the cable tie on the connector for the EDU (main wiring harness).	J37		Approx. 60 mm from relay location H (pin 2) in the main fuse box in the dashboard (main wiring harness).
	RHD	Approx. 160 mm from the cable tie on the connector for the EDU (main wiring harness).	J38	LHD	Approx. 160 mm from relay location M (pin 4) in the main fuse box in the dashboard (main wiring harness).
J30	LHD	Approx. 250 mm from the pre-wired mobile telephone connection, towards the instrument (main wiring harness).		RHD	Approx. 170 mm from relay location M (pin 4) in the main fuse box in the dashboard (main wiring harness).
	RHD	Approx. 25 mm from the branch to the radio connectors, towards the centre console (main wiring harness).	J39	LHD	Approx. 160 mm from relay location I (pin 2) in the main fuse box in the dashboard (main wiring harness).
J31	LHD	Approx. 100 mm from ignition switch (main wiring harness).		RHD	Approx. 190 mm from relay location I (pin 2) in the main fuse box in the dashboard (main wiring harness).
	RHD	Approx. 50 mm from the branch to the glove box lighting, towards fuse 10 (in main fuse box, dashboard).	J41	LHD	Approx. 210 mm from the right-hand side direction indicator, towards the dashboard (main wiring harness).
J32		Approx. 190 mm from the brake lights switch, towards the centre console (main wiring harness).		RHD	Approx. 150 mm from the RH side direction indicator, towards the dashboard (main wiring harness).
J33	LHD	Approx. 100 mm from the large branch in the LH front door, towards the rubber grommet (driver's door wiring harness).	J42	LHD	Approx. 310 mm from the right-hand side direction indicator, towards the dashboard (main wiring harness).
	RHD	Approx. 70 mm from the large branch in the LH front door, towards the rubber grommet (driver's door wiring harness).		RHD	Approx. 200 mm from the RH side direction indicator, towards the dashboard (main wiring harness).
J34	LHD	Approx. 115 mm from the pre-wired mobile telephone connection, towards the main fuse box in the dashboard (main wiring harness).	J43		Approx. 50 mm from the branch to the left-hand B pillar, towards the front door (main wiring harness).
	RHD	Approx. 95 mm from the branch to the radio connectors, towards the RH side of car (main wiring harness).	J44		Approx. 100 mm from the branch to the left-hand B pillar, towards the front door (main wiring harness).
J35	LHD	Approx. 240 mm from the brake lights switch, towards the LH front door (main wiring harness).	J51		Approx. 100 (SOP-275) mm from the data link connector under the RH front seat (main wiring harness).
	RHD	Approx. 370 mm from the terminal block (+30 circuit), towards connector H10-11 (main wiring harness).	J52		Approx. 190 mm from the rubber grommet in the side of the right-hand rear door (right-hand rear door wiring harness).
J36	LHD	Approx. 290 mm from the brake lights switch, towards the centre console (main wiring harness).	J53		Approx. 100 mm from the large branch in the right-hand front door, towards the rubber grommet (right-hand front door wiring harness).
	RHD	Approx. 50 mm from the branch for the radio connectors, towards the right-hand side of the car (main wiring harness).			

J55		Approx. 190 mm from the rubber grommet in the side of the left-hand rear door (left-hand rear door wiring harness).	J77	LHD	Approx. 305 mm from the cable tie on the connector for the EDU (main wiring harness).
J56		Approx. 150 mm from the central locking motor (luggage compartment wiring harness, CD).		RHD	Approx. 185 mm from the cable tie on the connector for the EDU (main wiring harness).
J58		Approx. 170 (SOP=100) mm from the main relay, ABS/(TC (main fuse box, ABS).	J78		Approx. 250 mm from the LH fog light switch, towards the RH side of car (front wiring harness).
J59		Approx. 100 (SOP=50) mm from the pump relay connector (main fuse box, ABS).	J79		Approx. 200 mm from the rear window wiper's 4-pin connector, towards the rear light fitting (luggage compartment wiring harness).
J60		Approx. 180 mm from grounding point G15, towards ABS valve block (main wiring harness).	J81		Approx. 280 mm from connector H6-5, towards the washer pump (washer pump wiring harness).
J63		Approx 280 mm from grounding point G15, towards ABS valve block (main wiring harness).	J86		Approx. 100 mm from the ABS control module connector (main wiring harness, discontinued during the model year).
J63B		Approx. 120 mm from the ABS valve block (main wiring harness).	J87		Approx. 100 mm from the ABS control module connector (main wiring harness, discontinued during the model year).
J67		Approx. 50 mm from the centre of the cable conduit, towards connector H70-1 (Trionic wiring harness).	J88		Approx. 100 mm from the ABS control module connector (main wiring harness, discontinued during the model year).
J68		Approx. 220 mm from the Trionic control module (Trionic wiring harness).	J89		Approx. 100 mm from the ABS control module connector (main wiring harness, discontinued during the model year).
J72	LHD	Approx. 200 mm from the pre-wired mobile telephone connection, towards the instrument (main wiring harness).	J93		In the branch to the glove box lid (main fuse box, dashboard).
	RHD	Approx. 340 mm from the brake lights switch, towards the main fuse box (main wiring harness).	J94	LHD	Approx. 380 mm from the branch to the left-hand B pillar, towards the front door (main wiring harness).
J73		In the branch to the glove box lighting (main fuse box, dashboard).		RHD	Approx. 390 mm from the branch to the left-hand B pillar, towards the front door (main wiring harness).
J74		In the branch to the glove box lighting (main fuse box, dashboard).	J95		In the branch to the glove box lid (main fuse box, dashboard).
J75	LHD	Approx. 150 mm from the terminal block (+15 circuit) in the main fuse box in the dashboard (main wiring harness).	J98		Approx. 130 mm from the LH fog light switch, towards connector H24-2 (front wiring harness).
	RHD	Approx. 100 mm from the branch to the glove box lid, towards fuse 10 (main wiring harness).	J99		Approx. 210 mm from the cable tie on connector H70-1 (engine bay side), towards the Trionic control module (engine wiring harness).

J101		Approx. 80 mm from the cable tie on connector H70-1 (engine bay side), towards the Trionic control module (engine wiring harness).	J122	Approx. 150 mm from grounding point G30, towards the LH light cluster (front wiring harness).
J102		Approx. 150 mm from the central locking system control module (main wiring harness).	J123	Approx. 160 mm from grounding point G30, towards the horn (front wiring harness).
J103		Approx. 100 mm from the central locking system control module (main wiring harness).	J124	Approx. 330 mm from the RH light cluster (front wiring harness).
J108		Approx. 180 mm from the output of fuse 17 in the main fuse box in the dashboard (main wiring harness).	J125	Approx. 140 mm from the connector for the engine wiring harness (injector wiring harness, V6).
J110		Approx. 135 mm from the switch in the side of the seat, towards 3-pin connector H3-10 or H3-11 (electrically adjustable front seat wiring harness).	J126	Approx. 150 mm from the connector for the Motronic control module (engine wiring harness, V6).
J111		Approx. 165 mm from the switch in the side of the seat, towards 3-pin connector H3-10 or H3-11 (electrically adjustable front seat wiring harness).	J127	Approx. 200 mm from the connector for the Motronic control module (engine wiring harness, V6).
J112		Approx. 195 mm from the switch in the side of the seat, towards 3-pin connector H3-10 or H3-11 (electrically adjustable front seat wiring harness).	J128	Approx. 180 mm from the connector for the main wiring harness (engine wiring harness, V6).
J114		Approx. 170 mm from the Trionic control module (engine wiring harness).	J129	Approx. 170 mm from the connector for the fuel injection wiring harness, in the cable conduit (front wiring harness).
J115		At the lead-through to the front main fuse box (front wiring harness).	J130	Approx. 325 mm from the connector for the front wiring harness (main wiring harness).
J116		At the lead-through to the front main fuse box (front wiring harness).	J131	Approx. 50 mm from the connector for the main wiring harness (roof wiring harness).
J117		At the lead-through to the front main fuse box (front wiring harness).	J132	Approx. 100 mm from the connector for the main wiring harness (roof wiring harness).
J118		Approx. 180 mm from fuse 16 (main fuse box, dashboard).		
J119		Approx. 55 mm from distribution terminal 231 (main fuse box, dashboard).		
J120	LHD	Approx. 280 mm from alarm code switch (main wiring harness).		
	RHD	Approx. 90 (SAP=130) mm from alarm code switch (main wiring harness).		
J121	LHD	Approx. 170 (SOP=230) mm from alarm code switch (main wiring harness).		
	RHD	Approx. 180 mm from alarm code switch (main wiring harness).		

Connector locations

1-pin connectors

H1-1	On the A/C compressor connection, at the far front to the right, above the manifold.
H1-2	In the right-hand front door below the door mirror.
H1-3	In the left-hand front door below the door mirror.
H1-4	Under the centre console beside the selector lever.
H1-5	In the roof console, beside the interior rear-view mirror.
H1-6	In the roof console, beside the interior rear-view mirror.

2-pin connectors

H2-1	Beside the coolant expansion tank.	H2-28	Beside the locking mechanism inside the right-hand rear door.
H2-3	To the left behind the front grille beside the left-hand headlamp.	H2-29	In the right-hand rear door, beside the fan motor.
H2-4	Adjacent to the radiator fan motor.	H2-30	In the right-hand rear door, beside the locking mechanism.
H2-5	In the front left-hand corner of the engine bay under main fuse box 342.	H2-32	Adjacent to the LED beside the left-hand loudspeaker grille.
H2-6	In the main fuse box behind the glove box adjacent to the seat-belt warning relay.	H2-33	In the left-hand A pillar.
H2-7	Adjacent to ventilation fan motor 199.	H2-34	Beside the locking mechanism inside the left-hand front door.
H2-8	Beside the ventilation fan motor.	H2-35	In the left-hand front door, beside the electric window lift.
H2-10	Beside the washer fluid reservoir.	H2-36	In the left-hand rear door, beside the locking mechanism.
H2-11	Beside the windscreen wiper motor.	H2-37	In the left-hand rear door, beside the fan motor.
H2-12	In the engine bay on the left-hand side adjacent to the brake fluid reservoir.	H2-38	Beside the locking mechanism inside the left-hand rear door.
H2-13	In the right-hand front door, beside the window lift.	H2-39	In the left-hand rear door, beside the electric window lift.
H2-14	In the passenger door, beside the locking mechanism.	H2-42	Beside the pre-wired location for the motorized aerial, on the left-hand side at the rear.
H2-15	In the right-hand A pillar.	H2-43	Beside the pre-wired location for the motorized aerial, on the left-hand side at the rear.
H2-16	Beside the locking mechanism inside the right-hand front door.	H2-46	In the engine bay behind the bulkhead on the far left.
H2-17	Adjacent to the heater control panel.	H2-47	In the engine bay behind the bulkhead on the far right.
H2-18	Behind the engine in the engine bay under the intake manifold.	H2-48	Under the rear seat on the left-hand side under the carpet.
H2-19	Under the dashboard to the left of the steering wheel.	H2-49	Under the rear seat on the right-hand side under the carpet.
H2-22	Beside the left-hand side direction indicator (green connector).	H2-52	Orange, short-circuiting connector, beside the steering wheel (LHD).
H2-23	Beside the right-hand side direction indicator, (green connector).	H2-56	To the left in the engine bay beside grounding point G15 and the Saab Trionic control module.
H2-24	Under the roof console beside the interior rear-view mirror.	H2-60	To the left under the right-hand front seat.
H2-25	In the front part of the roof, adjacent to the sunroof motor.	H2-62	To the left in the tailgate.
H2-27	In the right-hand rear door, beside the window lift.	H2-64	Beside the rear left-hand loudspeaker, not audio.
		H2-65	Beside the rear right-hand speaker, not audio.
		H2-66	In the engine bay behind the left-hand headlamp.
		H2-67	In the tailgate on the right-hand side.
		H2-69	Behind the extra fog light switch.
		H2-70	Beside the wiring harness, under front main fuse box 342.
		H2-73	Beside the locking mechanism in the driver's door.
		H2-74	In the luggage compartment on the right-hand side.

H2-75	Beside the ignition switch.	H4-3	Under the dashboard to the right, behind the radio compartment.
H2-76	Beside the front main fuse box, on the wiring harness.	(375)	
H2-77	Connector for passenger airbag.	H4-4	Beside the fuel pump under the luggage compartment floor.
H2-78	Behind the glove box beside the glove box lamp.	H4-12	Beside the right-hand wheel housing adjacent to the receiver.
H2-79	In the left-hand wheel housing beside the air pump.	H4-13	In the driver's door (adjacent to microswitch 274).
H2-80	Connector for passenger airbag.	H4-14	Beside the thermostatic switch on the right-hand side of the radiator.
H2-81	Behind the radio, EU.	H4-15	To the left under the right-hand seat.
H2-82	Connector, rear wiring harness, for subwoofer.	H4-16	In the engine bay behind the bulkhead partition, at far right (black).
H2-83	Connector, beside the rear left-hand subwoofer.	H4-17	In the engine bay behind the bulkhead on the far right (grey).
H2-84	Connector, for right-hand rear subwoofer.	H4-18	Beside the rear window wiper motor.
H2-85	Beside the radiator fan motor.	H4-19	Beside the locking mechanism in the passenger's door.
H2-86	Connector for horn switch adjacent to the steering wheel.	H4-20	In the centre console beside the selector lever.
H2-87	Adjacent to the rear-view mirror.	H4-21	Beside the generator, on V6 engine.
H2-88	Coding for manual gearbox/automatic transmission.	H4-23	On a bracket just behind the radiator, at bottom.
	3-pin connectors	H4-24	On a bracket to the left of the rear exhaust manifold.
H3-1	Behind the right-hand headlamp wiper motor.		6-pin connectors
H3-2	Behind the left-hand headlamp wiper motor.	H6-4	In the tailgate on the left-hand side beside the rear window.
H3-3	Under the right-hand seat.	H6-5	In the front right-hand corner behind the light cluster beside the washer fluid reservoir.
H3-5	Beside the windscreen wiper motor.	H6-6	To the right of the rear window wiper motor.
H3-9	In the engine bay below the intake manifold.	H6-8	In the tailgate next to motor 188.
H3-10	Under the left-hand seat, to the left on the electronics bracket.	H6-9	Amplifier connection to radio compartment in the centre console.
H3-11	Under the right-hand seat, to the right on the electronics bracket.		8-pin connector
H3-12	In the tailgate.	H8-2	Under the passenger's seat.
H3-20	Behind the main instrument display panel, adjacent to the speedometer.	H8-3	Under the driver's seat.
H3-21	In the tailgate.	H8-4	By the left-hand rear wheel housing.
H3-22	In the front part of the roof beside the sunroof motor.	H8-5	Beside the left-hand rear light fitting.
H3-23	Under the front bumper behind the right-hand fog light.	(258)	
H3-24	Adjacent to speed warning control module 356.	H8-8	Behind the radio socket.
H3-25	On the Cruise Control bracket.	H8-9	Behind the radio socket.
H3-26	Above the pedal bracket adjacent to the pedal switches.		10-pin connectors
H3-27	On a bracket just behind the radiator, at bottom.	H10-1	Under the anti-theft alarm control module, beside the glove box.
	4-pin connectors	H10-2	In the centre console behind the radio compartment.
H4-1	In the left-hand front door below the door mirror.	(267)	
H4-2	In the right-hand front door, below the door mirror.	H10-3	In the centre console behind the radio compartment.
		(267)	
		H10-4	Behind the glove box on the ACC servo motor unit.

- H10-5 Under the left-hand seat (green connector).
- H10-6 Beside the left-hand rear wheel housing.
- H10-9 Scan tool diagnostics data link connector under the right-hand seat.
- H10-11 On the far left under the dashboard (behind the knee shield).
- H10-12 To the left in the engine bay, below ABS main fuse box 302.
- H10-14 In the luggage compartment on the left-hand side, beside the filament monitor.
- H10-15 Behind the left-hand headlamp.
- H10-17 On the valve block.
- H10-18 On the electronic ignition module.
- H10-22 In right-hand B pillar.
- H10-23 Saab Trionic data link connector. Small round black connector beside the Trionic control module (for production only).
- H10-24 In the left-hand B pillar.
- H10-25 Behind the left-hand headlamp.
- H10-26 Behind the left-hand headlamp.

22 pin connectors

- H22-1 Behind the cable entry in the left-hand A pillar.
- H22-2 Behind the cable entry in the right-hand A pillar.

24 pin connector

- H24-2 Behind the left-hand headlamp.

25-pin connector

- H25-1 Jumper connector instead of anti-theft alarm control module.

70-pin connector

- H70-1 In the engine bay, behind the bulk-head partition.



SAAB

Saab Automobile AB
Trollhättan, Sweden



Ordering No. 364331. English edition. Printed in Sweden. © Saab Automobile AB, 1995.

