

SAAB

Accessories Reference Catalog

May 1997



SAAB

**INDEX****A**

Airflow Kits	68-71
Alarm System	26
Antennas, Radio	21-24
Antifreeze	102
Armrests	85
Audio Systems	4-19

B

Back-Up Alert	98
Booster Cables	99
Brake Light (Center Mount)	58

C

Carbon Fiber Dash Treatment and Trim	75
Car Care Products	101
Car Covers	87
Cargo Mats (Trunk)	94
Cargo Stabilizer, Orderly	95
Carrying Case (Radios)	25
Cassette Storage Box	25
CD Changer	20
Cellular Telephone Accessories	36-38
Child Seats	86
Cigarette Lighter Accessory Plug	97
Console Adapters (Gauges & Cassette Holders)	78-79
Consoles	77
Convertible Soft Boot Cover	91
Cruise Control	30-32
Cup Holders	90

D

Dashboard Sunshade	96
Decor Panels	73
Dog Guard	92
Door Edge Guards	57
Driving Computers	35

E

Engine Block Heaters	100
----------------------	-----

**F**

Fender Flares	72
Firm-Fit Lighter Spacers	97
First Aid Kit	99
Flashlight (Rechargeable)	99
Floor Mats:	
Carpet	80-81
All-Season	82
Rubber	83-84
Fog Lights	27-29

G

Gauges	33
Gearshift Components (Knobs & Boot Kits)	76

H

Handling Kits	47-48
Headrests (Rear)	88-89
Hood Protection Strips	57
Hubcaps & Wheel Covers	43

K

Keypad Leather Case (Radio)	25
-----------------------------	----

L

License Plates & Frames	74
Locking Gas Cap	1
Luggage Nets	93

M

Moon/Sun Roof	56
Mud Flaps	61-62

R

Radar Detector	97
Relays (Door Chime & Day Running System)	34
Rack Systems	
Roof Mounted	63-64
Trunk Mounted	65

S

Skid Plate	60
Snow Tires	46
Spoilers	49-53
Sport Exhaust System	2-3



SAAB

ACCESSORIES

Steering Wheels (Sport)	39
Storage Boxes (Trunk)	95

I

Tape Deck Cleaner	25
Tire Chains & Cables	100
Tire Gauge	99
Touch-Up Paint	59
Tow Line	99
Trailer Hitches	66-67
Trunk Handles	57

W

Warning Triangle Kit	99
Wheels	40-42, 44-45
Wheel Bolt Caps	43
Wind Deflectors	54-55
Windscreen, Convertible	54
Windshield Washer Fluid Heater	100
Winter Wiper Blades	100
Wood Dash Treatment and Trim	75



Subject: Locking Gas Cap

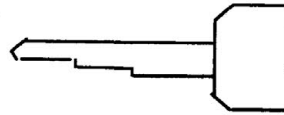
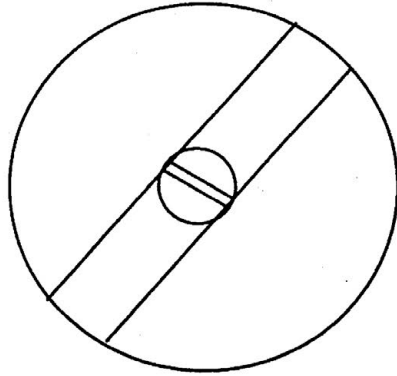

Description	Part Number	Application	Notes
Cap, Unvented Threaded	41 64 372	900 81-95 9000 86-	



Subject: Sport Exhaust 900 – 93, 94 CV

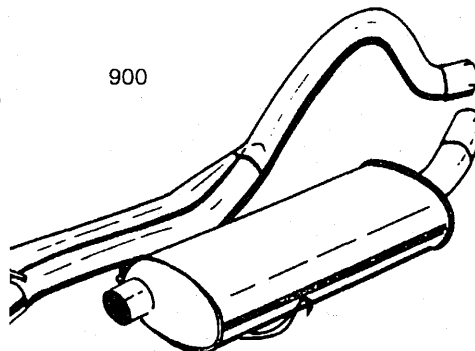
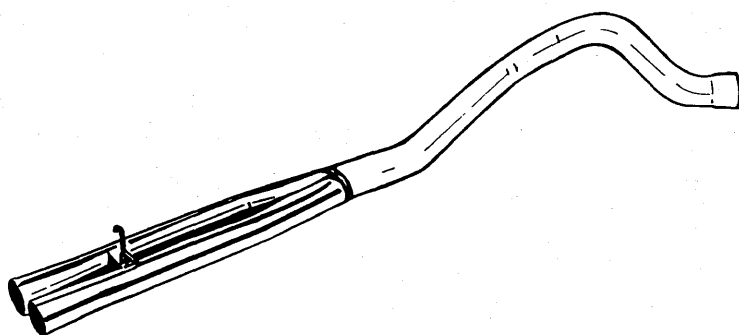

Description	Part Number	Application	Notes
Chromed Twin Outlet Tailpipe	02 44 137	900 Turbo 84-86	M.S. to 02 43 733 Muffler (Discontinued) 75 38 440 MT Kit 02 43 725 Pipe (Discontinued)
Sport Exhaust System Kit	00 27 094	900 Turbo 84-93, 94CV	(Discontinued)
<ul style="list-style-type: none"> • Muffler • Rubber Strap • Rubber Strap • Clamp • Strap Hook-Left Side • Strap Hook-Right Side • Self Tapering Screw • Washer • Template • Bracket 	<ul style="list-style-type: none"> 02 72 492 93 28 105 93 65 404 83 36 406 75 11 660 75 11 652 79 73 621 71 19 845 75 25 256 93 68 093 	(Discontinued)	M.S. to 02 43 733 Muffler 75 38 440 MT Kit 02 43 725 Pipe (Discontinued)
Heat Shield – Muffler	75 11 645		Must be mounted when installing Sport Exhaust Kit on M 81-83 900
Sport Exhaust Muffler	02 43 725	900 Turbo 84-93, 94CV	(Discontinued)
<ul style="list-style-type: none"> • Rubber Strap • Clamp • Straphook – LH • Straphook – RH • Screw • Washer • Bracket 	<ul style="list-style-type: none"> 93 28 105 83 36 406 75 11 660 75 11 652 79 73 621 71 19 845 93 68 093 		



Subject: Sport Exhaust 900 – 93, 94 CV (continued)

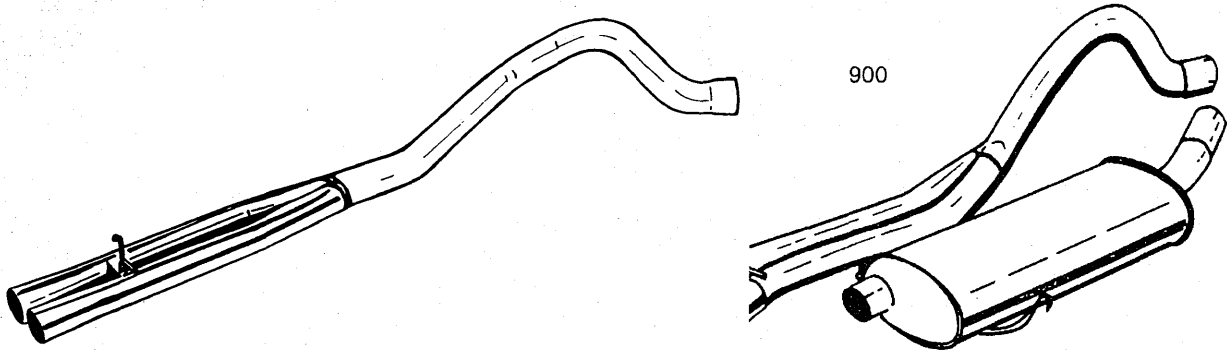

Description	Part Number	Application	Notes
Sport Exhaust Tailpipe	02 43 733	900 Turbo 87-93, 94CV	Can be combined with O.E. muffler or sport muffler.
<ul style="list-style-type: none">• Rubber Strap• Clamp	93 65 404 83 36 406		
Sport Exhaust System	02 51 306	Turbo Models 3D/5D 94-, CV 95-	Complete "Cat-Back" system, including high-polished tip. All stainless steel.
Tip	02 51 314	Turbo Models 3D/5D 94-, CV 95-	Same as one included in 02 51 306. Can be fitted to OE tailpipe.



Subject: Audio



Description	Part Number	Application	Notes
SAAB SPEAKERS FRONT SPEAKERS:			
High Performance Front Speaker Set	02 57 709	900 79-93, 94CV	Mounted on Defroster Grille (Discontinued) Alternative to 02 58 848
<ul style="list-style-type: none"> • H.P. Front Speaker R.H. • H.P. Front Speaker L.H. 	02 73 318 02 73 326		
Front Speaker + Amp kit	02 48 633	94- 900	(Not 94CV)
Wiring Harness (separate, but necessary)	02 48 641	94- 900	

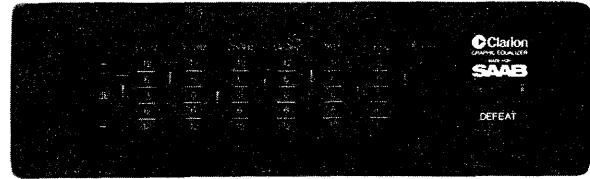
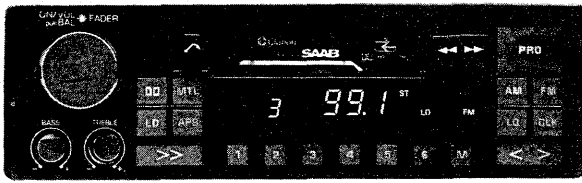

Description	Part Number	Application	Notes
SAAB-CLARION SOUND SYSTEM	02 61 743	900 84-85	Original equipment on Turbo (Discontinued)
<ul style="list-style-type: none"> Wiring Harness 	02 61 230	84-85	Radio to Equal.
<ul style="list-style-type: none"> Radio Chassis Mounting Bracket 	02 61 792	84-85	Dash Mounting
<ul style="list-style-type: none"> Equalizer Mounting Bracket 	02 61 420	84-85	Console Mounting (Discontinued)
<ul style="list-style-type: none"> Equalizer Side Brackets 	02 61 453	84-85	Set of 2 (Discontinued)
<ul style="list-style-type: none"> Adapter Cable 	02 61 313	84-85	Radio to Saab wiring
KNOBS:			
<ul style="list-style-type: none"> Radio On/Off Balance Knob 	02 61 347	84-85	
<ul style="list-style-type: none"> Radio Fader Knob 	02 61 362	84-85	
<ul style="list-style-type: none"> Radio Bass/Treble Knob 	02 61 396	84-85	(Discontinued)
<ul style="list-style-type: none"> Equalizer Slide Knob 	02 61 339	84-85	
Fuse 7.5 Amp	02 61 461		



Subject: Saab Clarion Turbo Sound System 1986

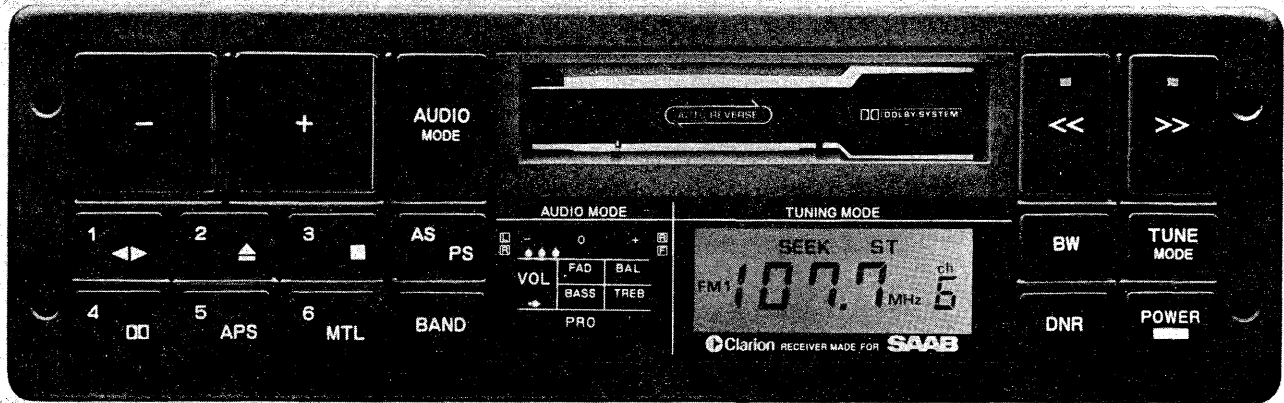

Description	Part Number	Application	Notes
Turbo Radio Kit	02 73 011	900, 9000 '86	(Discontinued)
<ul style="list-style-type: none"> • Radio Head • Radio Bracket • Equalizer <ul style="list-style-type: none"> •• Equalizer/Amp Bracket •• Equalizer Cover • Power Adapter Cord • Removal Tools • Window Stickers • Hang Tag 	02 73 409 02 73 094 02 73 052 02 73 086 02 73 300 02 73 110 02 73 128 02 79 190 02 79 208		(Discontinued)
900 Turbo Installation Kit	02 73 037	900 Turbo Only	
<ul style="list-style-type: none"> • DIN Cord • Felt Pad Kit 	02 73 102 02 43 170		1 Meter long (Discontinued)
10 Amp Fuse – Blade Type	79 74 637		
3 Amp Fuse – Blade Type	02 61 826		(Discontinued)



Subject: Saab Clarion "S" Sound System 1986

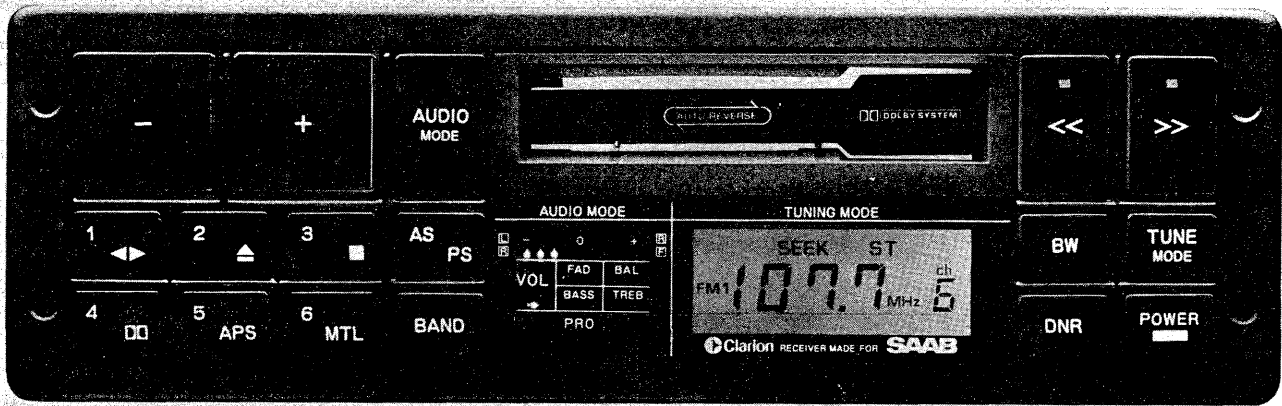

Description	Part Number	Application	Notes
"S" Radio Kit	02 73 029	900 "S" '86	(Discontinued)
• Radio Head	02 73 409		(Discontinued)
• Radio Bracket	02 73 094		
• Felt Pad Kit	02 43 170		
• Tidy Box Kit/Bracket	02 73 078		(Discontinued)
•• Amplifier Bracket	02 73 086		
• Power Adapter Cord	02 73 110		13 Pin to 2 x 10 Pin (Discontinued)
• DIN Cord – AMP to Radio	02 73 102		(Discontinued)
• Removal Tools	02 73 128		
• Window Stickers	02 79 190		
• Hang Tag	02 79 208		
Suppressor Kit	02 73 292	900, "S", Turbo	
Snap-in Tidy Box	02 73 417	900	Fills dash opening left by removed radio
10 Amp Fuse – Blade Type	79 74 637		



Subject: Saab Clarion Turbo Sound System 1987

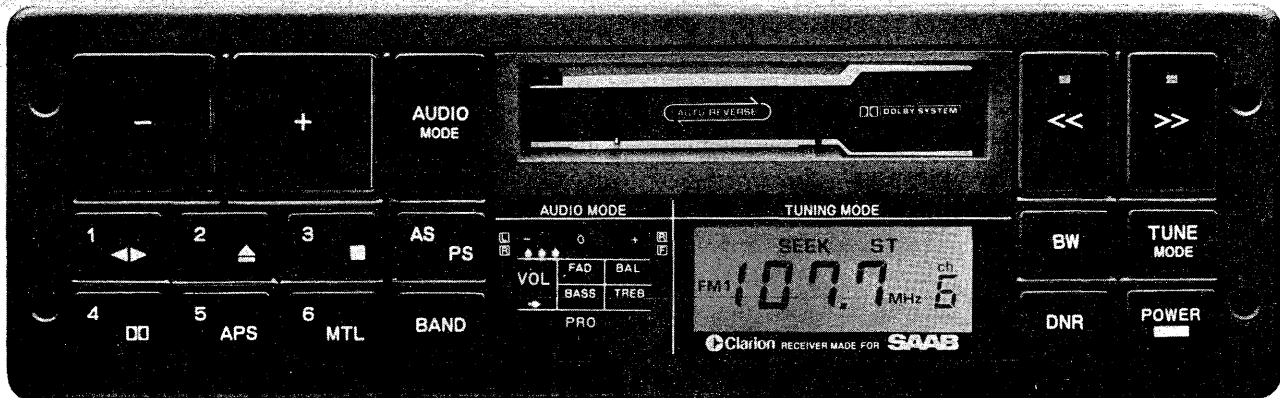

Description	Part Number	Application	Notes
Turbo Radio Kit	02 73 375	900, 9000 '87	(Discontinued)
• Radio Head	02 73 409		(Discontinued)
• Radio Bracket	02 73 094		
• Equalizer	02 73 052		
•• Equalizer/Amp Bracket	02 73 086		
•• Equalizer Cover	02 73 300		
• Power Adapter Cord	02 73 110		13 Pin to 2 x 10 Pin (Discontinued)
• Removal Tools	02 73 128		
• Window Stickers	02 79 190		
• Hang Tag	02 79 208		
900 Turbo Installation Kit	02 73 037	900 Turbo Only	
• DIN Cord	02 73 102		1 Meter long (Discontinued)
• Felt Pad Kit	02 43 170		
10 AMP Fuse – Blade Type	79 74 637		



Subject: Saab Clarion "S" Sound System 1987

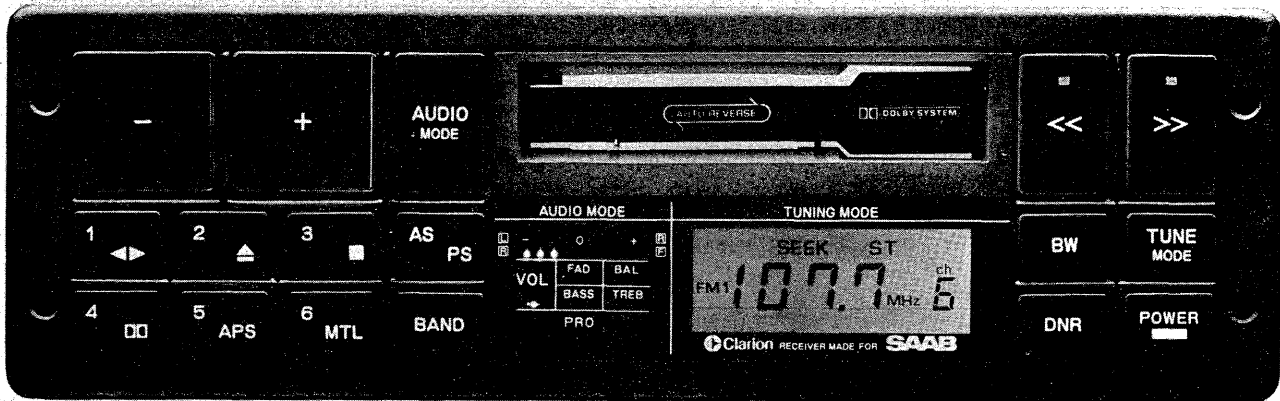

Description	Part Number	Application	Notes
"S" Radio Kit	02 73 383	900, 9000 '87	(Discontinued)
• Radio Head	02 73 409		(Discontinued)
• Radio Bracket	02 73 094		
• Tidy Box Kit/Bracket	02 73 078	-1987-1/2 900S	Cars without passive belts
•• Amplifier Bracket	02 73 086	-1987-1/2 900S	Cars without passive belts
• Power Adapter Cord	02 73 110		13 Pin to 2 x 10 Pin (Discontinued)
• Removal Tools	02 73 128		
• Window Stickers	02 79 190		
• Hang Tag	02 79 208		
900 "S" Installation Kit	02 73 433		(Discontinued)
• DIN Cord	02 73 102		1 Meter long (Discontinued)
• Felt Pad Kit	02 43 170		
Amplifier Bracket and Grill	02 73 615	900 "S", 1987-1/2	Cars with passive seat belts
10 AMP Fuse – Blade Type	79 74 637		
Suppressor Kit	02 73 292	900, "S" Turbo 9000	
Snap-in Tidy Box	02 73 417	900	Fills dash opening left by removed radio



Subject: Saab Clarion AM-FM Cassette 1986-1987

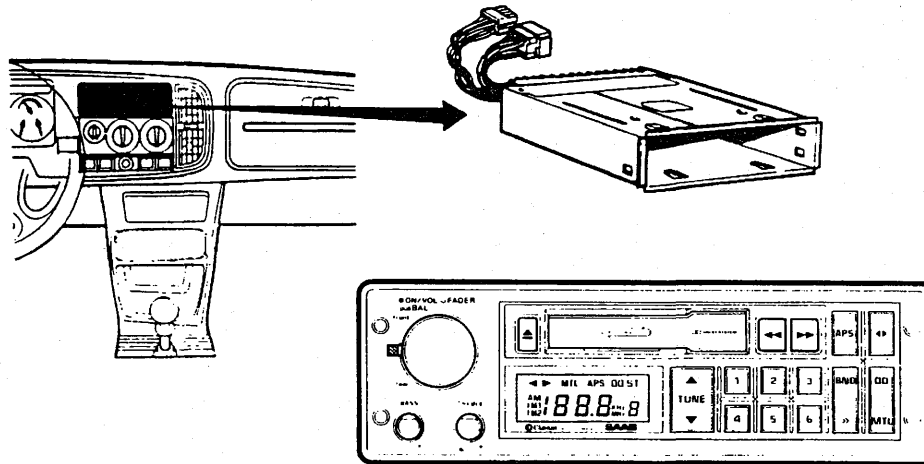

Description	Part Number	Application	Notes
AM/FM Stereo Cassette	02 73 177		Multiple Supercession: 02 84 299 and 95 28 209
<ul style="list-style-type: none"> • Removal Tools • Radio Bracket • On/Off Balance Knob • Fader Knobs • Bass/Treble Knob • Felt Pad Kit 	02 73 128 02 73 193 02 73 201 02 61 362 02 73 219 02 43 170	900 '86-'87	2 per radio
Adapter Cable	02 73 185		Allows -91 Radios to be installed in 83-85 900 cars.
Owners Manual	02 73 227	1986	



Subject: Saab Clarion Sound System 1988

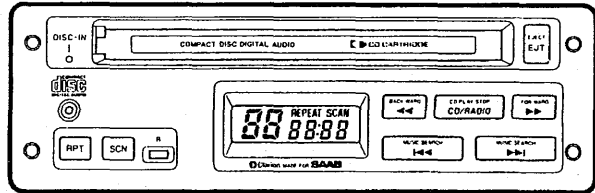
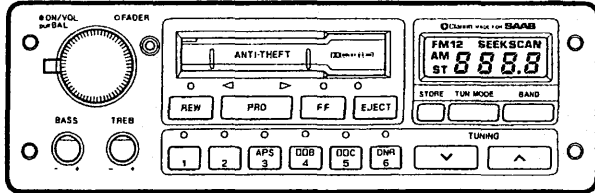
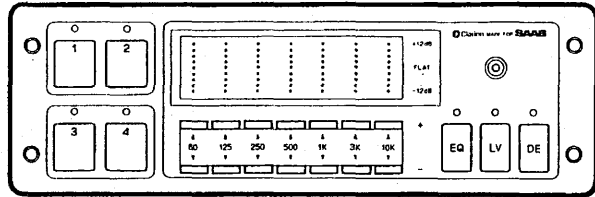

Description	Part Number	Application	Notes
Radio Head	02 73 672	900 S, 900 T '88 9000 S, 9000 T '88	(Discontinued)
<ul style="list-style-type: none"> Power/Volume Knob Base/Treble Knob Fader Knob 15 Amp Fuse Removal tools Code Cards Window Stickers 	02 73 730 02 73 755 02 61 362 79 74 645 02 73 706 02 84 281 02 79 190		2 per radio
Equalizer	02 47 023	900 T, 9000 T '88	
Equalizer/CD Bracket*	95 27 979	900 T, 9000 T '88	For slide-out EQ and CD.
DIN Cord	95 28 217	900 '88	
3-DIN Audio Installation Kit	02 47 122	9000 '88 (Discontinued)	Enables the CD player and the EQ to be installed together with the radio/cassette.
<ul style="list-style-type: none"> 3-DIN Cable DIN basket 	02 47 130 02 47 148		
CD Player Anti Vibration Bracket	02 47 163	900 '88	Secures the rear of the CD basket to the center console to help eliminate any skip that may occur.
Owners Manual	02 73 714		For all 88 audio components.
Suppressor Kit	02 73 292	900, 9000 '88	

*Note: When adding EQ/CD bracket to 900 S, DIN cord 95 28 217 is needed. Also, for EQ/CD option to be added to passive restraint equipped cars built prior to VIN -J3016068 Red, VIN -J3015727 Tan, VIN -J3016252 Blue, VIN -J3015762 Grey, later version knee panels are required. See parts microfiche.



Subject: Saab Clarion AM-FM Cassette 1988

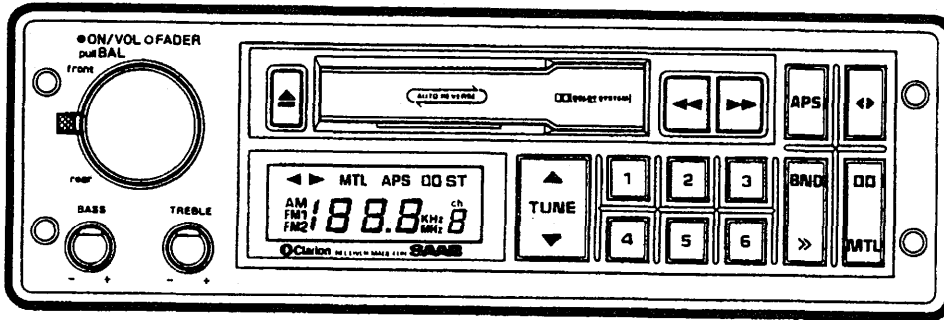

Description	Part Number	Application	Notes
AM/FM Stereo Cassette	02 84 299	900 '88	
<ul style="list-style-type: none"> Removal Tools Power/Volume Knob Bass/Treble Knob Fader Knob 	02 73 128 02 73 201 02 73 219 02 61 362	900 '86-88	Includes carrying pouch 2 per radio
Radio Slide-Out Bracket	95 28 209	900 '88	Slide out bracket for 02 84 299
Owners Manual	02 73 714		For all 88 audio components
Suppressor Kit	02 73 292	900 '88	



Subject: Saab Clarion Sound System 1989

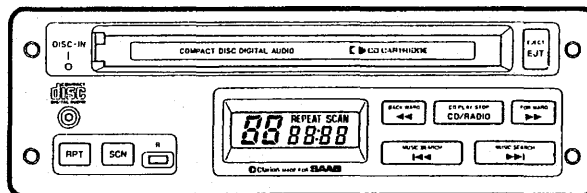
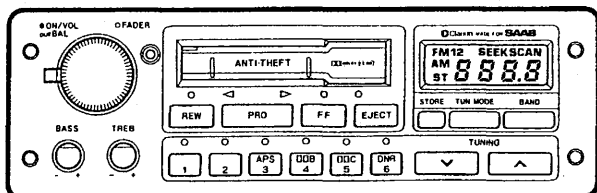
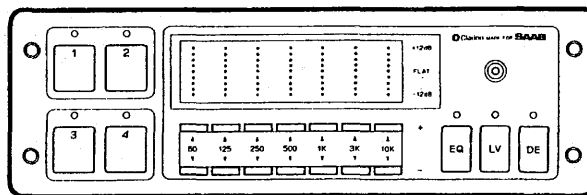

Description	Part Number	Application	Notes
Radio Head	02 47 007	900 T, 9000 T	(Discontinued)
<ul style="list-style-type: none"> Power/Volume Knob Base/Treble Knob Fader Knob 15 Amp Fuse Removal Tools Code Cards Window Stickers 	02 73 730 02 73 755 02 61 362 79 74 645 02 73 706 02 47 072 02 79 190		2 per radio
Radio Bracket with Amp	40 61 396	900 CV, 9000 CD	
Equalizer	02 47 023	900 T, 9000 T	Optional for 900, 900S, 9000S
Equalizer/CD Bracket	95 27 979	900 T, 9000 T	
3-DIN Audio Installation Kit	02 47 122	9000 (Discontinued)	Enables the CD player and the EQ to be installed together with the radio/cassette.
<ul style="list-style-type: none"> 3-DIN Cable DIN Basket 	02 47 130 02 47 148		
CD Player Anti Vibration Bracket	02 47 163	900	Secures the rear of the CD basket to the center console to help eliminate any skip that may occur.
DIN Cord	95 28 217	900 T	Amplifier to Equalizer/CD bracket
Suppressor Kit	02 73 292	900, 9000	



Subject: Saab Clarion AM-FM Cassette 1989

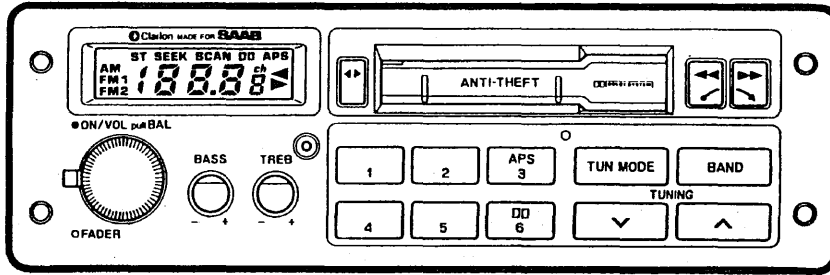

Description	Part Number	Application	Notes
AM/FM Stereo Cassette	02 47 015	900, 900S, 9000S	Includes storage pouch 2 per radio
• Removal Tools	02 73 706		
• Power/Volume Knob	02 47 049		
• Bass/Treble Knob	02 73 755		
• Fader Knob	02 47 056		
• Code Cards	02 47 072		
• Window Stickers	02 79 190		
Suppressor Kit	02 73 292	900, 9000	



Subject: Saab Clarion Sound System 1990

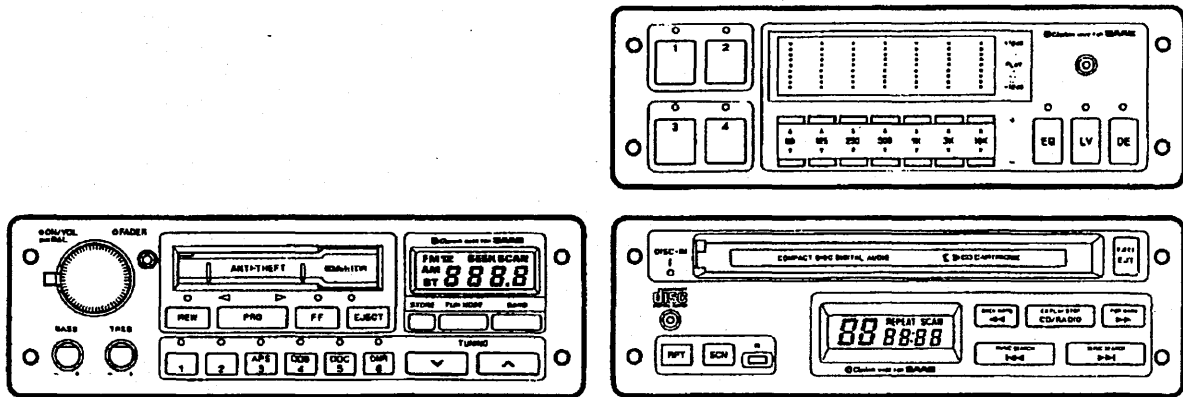

Description	Part Number	Application	Notes
Radio Head	02 47 098	900 T, 9000 T	(Discontinued)
<ul style="list-style-type: none"> • Power/Volume Knob • Base/Treble Knob • Fader Knob • 15 Amp Fuse • Removal Tools • Code Cards • Window Stickers 	02 73 730 02 73 755 02 61 362 79 74 645 02 73 706 02 47 106 02 79 190		2 per ratio Includes storage pouch
Radio Bracket with Amp	40 61 396	900 CV, 9000 CD	
Equalizer	02 47 023	900 T, 9000 T	Optional for 900, 900 S, 9000 S
Equalizer/CD Bracket	95 27 979	900 T, 9000 T	
3 DIN Audio Kit	02 47 122	9000 (Discontinued)	Enables the CD player and the EQ to be installed together with the radio/cassette.
<ul style="list-style-type: none"> • 3-DIN Cable • DIN Basket 	02 47 130 02 47 148		
CD Player Anti Vibration Bracket	02 47 163	900	Secures the rear of the CD basket to the center console to help eliminate any skip that may occur.
DIN Cord	95 28 217	900	Amplifier to Equalizer/CD bracket
Suppressor Kit	02 73 292	900, 9000	
Adapter Cable	02 73 185		Allows -91 radios to be installed in 83-85 900 cars.



Subject: Saab Clarion AM-FM Cassette 1990

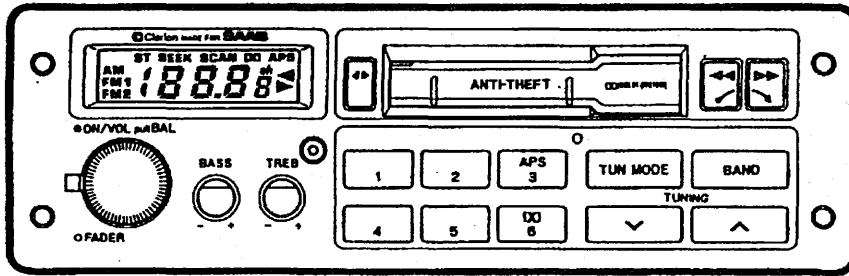

Description	Part Number	Application	Notes
Radio Head	02 47 015	900, 900S, 9000S	
<ul style="list-style-type: none"> • Power/Volume Knob • Base/Treble Knob • Fader Knob • Removal Tools • Code Cards • Window Stickers 	02 47 049 02 73 755 02 47 056 02 73 706 02 47 072 02 79 190		2 per radio Includes storage pouch
Equalizer	02 47 023		Optional for 900, 900S, 9000S
Equalizer/CD Bracket	95 27 979		For installing EQ or CD in 900, 900S, 9000S
3-DIN Audio Installation Kit	02 47 122	9000S (Discontinued)	Enables the CD player and the EQ to be installed together with the radio/cassette.
<ul style="list-style-type: none"> • 3-DIN Cable • DIN Basket 	02 47 130 02 47 148		
CD Player Anti Vibration Bracket	02 47 163	900, 900S	Secures the rear of the CD basket to the center console to help eliminate any skip that may occur.
DIN Cord	95 28 217	900, 900S	Amplifier to Equalizer/CD bracket
Suppressor Kit	02 73 292	900, 9000	



Subject: Saab Clarion Sound System 1991 Non-Turbo

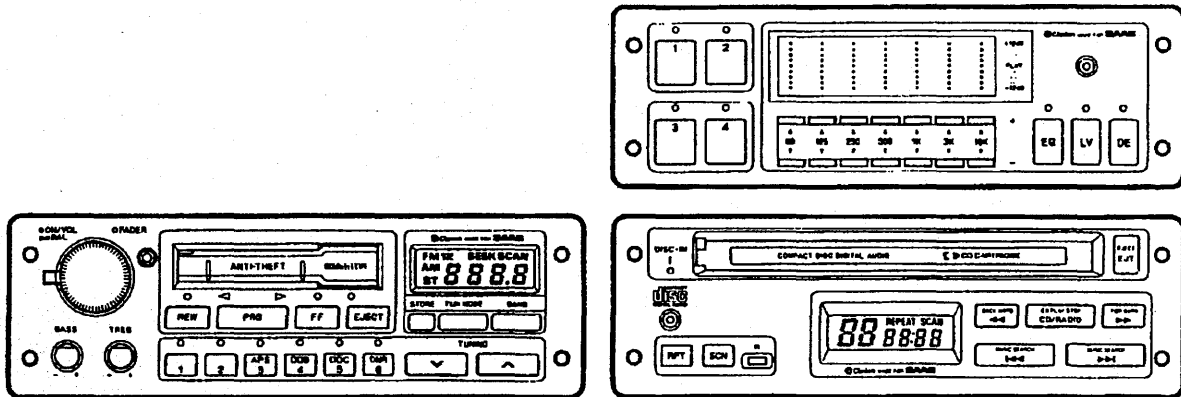

Description	Part Number	Application	Notes
Radio Head	02 47 015		
Power/Volume Knob	02 47 049		
Base/Treble Knob	02 73 755		
Fader Knob	02 47 056		
Removal Tools	02 73 706		Includes storage pouch
Code Cards	02 47 072		
Window Stickers	02 79 190		
Radio Bracket with Amp	41 11 100		9000S, 900
Radio Bracket with Amp	40 61 396		9000 CD
Equalizer	02 47 023		Optional
Equalizer/CD Bracket	95 27 979		For installing EQ or CD in non-turbo
3-DIN Audio Installation Kit (Discontinued)	02 47122		9000, Enables the CD player and the EQ to be installed with the radio/cassette. (Discontinued)
• 3-DIN Cable	02 47 130		
• DIN Basket	02 47 148		
CD Player Anti Vibration Bracket	02 47 163		900, Secures the rear of the CD basket to the center console to help eliminate any skip that may occur.
DIN Cord	95 28 217		900, Amplifier to Equalizer/CD bracket
Suppressor Kit	02 73 292		900
1991 Owner's Manual	02 14 726		(Discontinued)



Subject: Saab Clarion Sound System 1991 Turbo

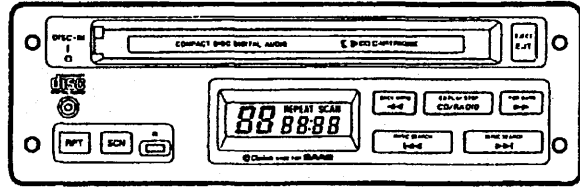
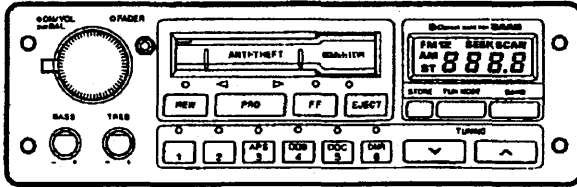
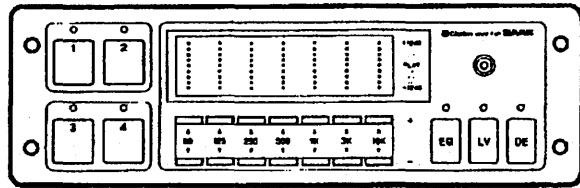

Description	Part Number	Application	Notes
Radio Head (Discontinued)	02 47 098		
• Power/Volume Knob	02 73 730		
• Base/Treble Knob	02 73 755		
• Fader Knob	02 61 362		
• 15 Amp Fuse	79 74 645		
• Removal Tools	02 73 706		
• Code Cards	02 47 106		
• Window Stickers	02 79 190		
Radio Bracket with Amp	41 11 100		900, 9000 5-door
Radio Bracket with Amp	40 61 396		900 CV, 9000 CD
Equalizer	02 47 023		
Equalizer/CD Bracket	95 27 979		
3-DIN Audio Installation Kit	02 47 122		9000, Enables the CD (Discontinued) player and the EQ to be installed together with the radio/cassette. (Discontinued)
• 3-DIN Cable	02 47 130		
• DIN Basket	02 47 148		
CD Player Anti Vibration Bracket	02 47 163		900, Secures the rear of the CD basket to the center console to help eliminate any skip that may occur
DIN Cord	95 28 217		900, Amplifier to Equalizer/CD bracket
Suppressor Kit	02 73 292		900



Subject: SAAB Clarion Sound System
1992 – 1993, 94 CV 900
1992 – 1994 9000

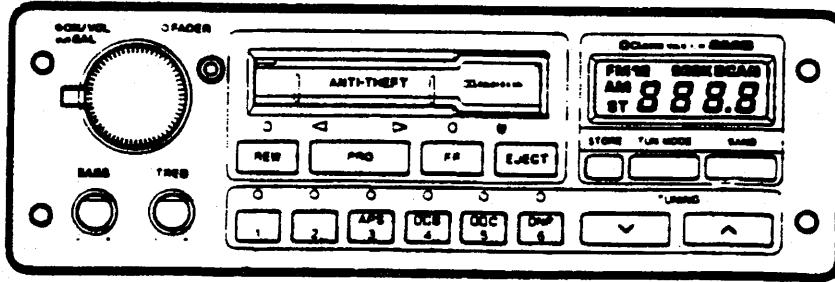

Description	Part Number	Application	Notes
Radio Head	02 47 502	Turbo	
Radio Head	02 47 510	Non-Turbo	
Radio Bracket/Amplifier	40 83 036		
CV Bracket/Amplifier	40 65 405		
CD/Graphic Equalizer	02 47 528		
Graphic Equalizer	02 47 536		
CD/Graphic Equalizer Bracket	40 83 044		
CD/EQ DIN Cord	40 83 168	900 only	
CD Autochanger	02 48 708	Supercedes TO 02 49 870	
CD Autochanger, Data Cable	40 83 291		
CD Autochanger, Disc Magazine	02 47 585		
CD Autochanger, Bracket Kit:			
	02 47 593	900 3 and 4 Door	
	02 47 601	900 Convertible	
	02 47 619	9000	
	02 47 957	9000 CS	Adapter bracket 02 49 888 must also be used when installing slim line changer 02 49 870.
Rear Amplifier	40 83 051		
Rear Amplifier DIN Cable	40 85 270	900	
Rear Amplifier DIN Cable	40 83 085	9000	
Shorting Plug	40 85 197	Base and S	
900 "4" Front Spkr	40 85 189	All	
4" x 10" Rear Spker	40 83 150	900 3D, 4D	
6" Rear Spkr	41 68 563	900 CV	
1" Front Tweeter	40 85 148	9000	
4" Front Woofer	40 67 534	9000	

(continued next page)

**SAAB**

ACCESSORIES

Description	Part Number	Application	Notes
Rear Spker Assy-Left	40 83 119	9000 5D	
Rear Spker Assy-Right	40 83 127	9000 5D	
Rear Spker Assy-Left	40 83 275	9000 4D	
Rear Spker Assy-Right	40 83 283	9000 4D	
Removal Tools with Pouch	02 73 706		
Radio Carry Bag	02 73 136		
Tidy Box	02 73 417		
Power/Volume/Balance/Fader Knob	02 47 627		
Bass/Treble Knobs	02 47 635		2 per car
15 Amp Fuse Blade Type (Blue)	79 74 645		



**Subject: CD Changer & Miscellaneous
94 – 900 (Not 94 CV)
95 – 9000 All**

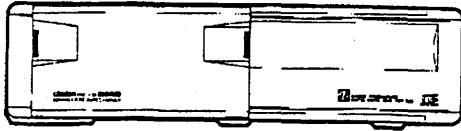

CD Autochanger

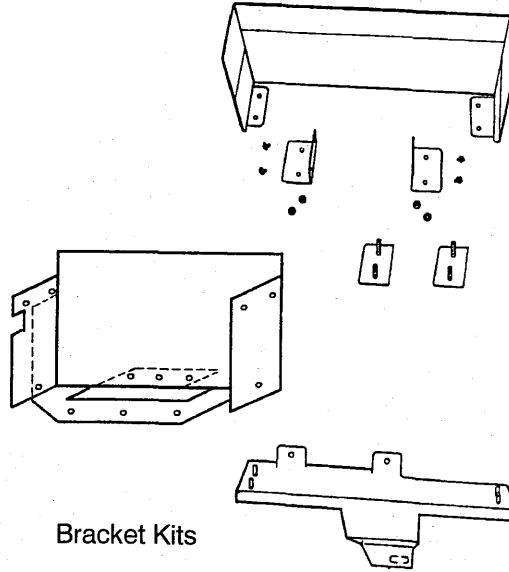

Bracket Kits

Description	Part Number	Application	Notes
CD Auto Changer	02 49 870	94– 900 (Not 94 CV) 95– 9000	New Slimline
Changer Bracket	02 49 920	94– 900 3D/5D, 95–CV	New Slimline
Changer Bracket	02 47 957	9000 CS & CD	(Also need 02 49 888)
Adapter Bracket	02 49 888	9000 CS & CD	New Slimline
CD Auto Changer	02 48 708	94– 900 (Not 94 CV) 95– 9000 All	Old Style, will supercede to 02 49 87
Changer Bracket	02 48 682	94– 900 (Not 94 CV)	Old Style *
Changer Bracket	02 47 957	9000 CS & CD	Old Style *
CD Cartridge	02 47 585	All	
CD Cartridge Slim Line	02 49 896		
Adapter Cable	02 49 664	9000 (when using in–dash and CD Autochanger together)	
Volume Knob	02 48 773	94– 900	
Bass, Treble, Fade or Balance Knob	02 48 781	94– 900 3D/5D, 95 CV	Up to Radio Serial #2041481
Bass, Treble, Fade or Balance Knob	02 52 874		From Radio Serial #2041482
ON/OFF Volume Knob	02-49-805	95– 9000	

All other 94– 900/95– 9000 audio spare parts can be found on the Spare Parts Microfiche.

*When installing new slimline changer part #02 49 870 you must also use adapter 02 49 888 with old style bracket.

*See PSI Section 3, Page 92 for installation assistance.



Subject: Saab Antennas Non-Power

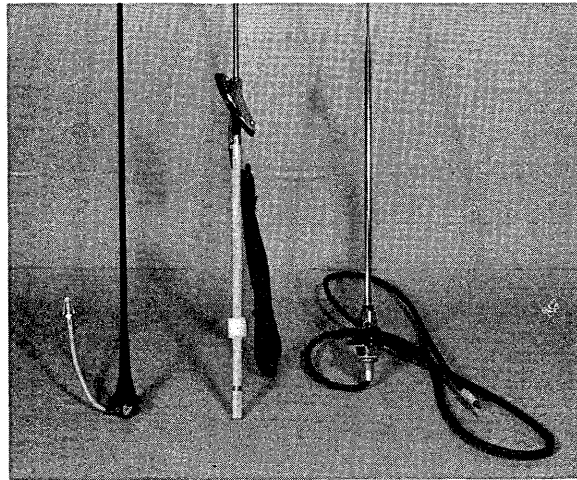

Description	Part Number	Application	Notes
Telescoping Antenna	02 62 071	900, 99	Will not fit in antenna hole for Harada remotes.
Antenna Keys	02 62 170		Two per package. For extracting Antenna Mast from down position.
Antenna Cleaning Tool	02 62 139		Tool for cleaning antenna hole for proper ground
Fixed Length Black Short Lead	02 59 986	900 99, 78-	NOTE: Hole size for 3 door should be drilled to 12mm.
Antenna Wrench	02 62 089		Wrench for removing mast on fixed antenna. (Discontinued)
Fixed Length Black (Lead 4.6 Meters = 15 ft.)	02 57 873		
Chrome Retractable	02 58 343	99, -77	Rear Fender mount replacement antenna.



Subject: Power Antennas



Description	Part Number	Application	Notes
Antenna Kit	02 59 895	900 4SN 1981	With CBX 6 Relay Original equipment Turbo superseded to 02 58 020
Antenna Kit	02 58 020	900 4SN 1982 1/2	With RY2 Relay Original equipment Turbo
RY 2 Relay	02 58 475		With 02 58 020
Antenna Replacement			
Mast	02 58 319		Black
Antenna Bracket	02 58 970		(Discontinued)
Retaining Nut with O-Ring	02 58 889		Black (Discontinued)
Antenna Lead 197 inches	02 58 368		
Antenna Kit	02 58 012	900 3 CK 81-82 ¹ / ₂	With RY2 Relay Original Equipment Turbo
• RY 2 Relay	02 58 475		With 02 58 012
• Antenna Replacement	02 58 327		Black tail w/ teeth
• Mast			
• Remaining Nut with O-Ring	02 58 889		Black (Discontinued)
• Antenna Lead 197 inches	02 58 368		



Subject: Nippon-Saab Power Antenna Kit

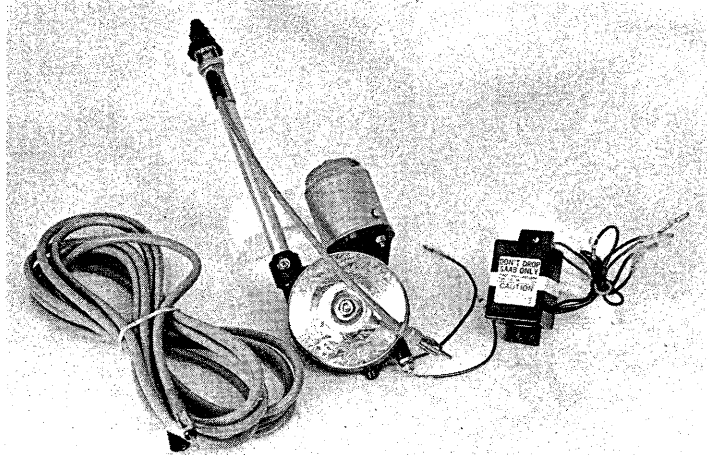

Description	Part Number	Application	Notes
Antenna Complete	02 58 210	900 83-84	Original Equipment Turbos (Discontinued)
• Antenna Mast	02 58 228		No tail
• Relay	02 58 236		
Bracket	85 86 190	900 83-84	4 SN factory installation
Screw for Bracket	79 22 891		
Bracket	02 57 576	900 83-	3 CK early production (Discontinued)
Antenna Extension Cable 12 inches	02 57 543		
Antenna Lead 197 inches	02 58 368		



Subject: Saab Harada Power Antenna Kit
900 85 - 93, 94CV
9000 86 - 95

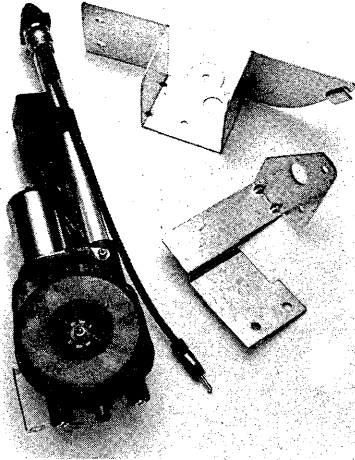

Description	Part Number	Application	Notes
Antenna Kit	02 61 909	900 85-93, 94CV 9000 86-92 5D 89-94 CD	
• Antenna Mast	02 61 974		Tail w/ teeth
• Relay	02 62 055		
• Bezel Kit	02 62 063		
Bracket	02 61 925	900 2/4 Dr.	
Bracket	02 61 941	900 3 Dr.	
Bracket	95 07 971	9000	
Antenna Kit	40 86 732	9000 CD -94	
• Mast	02 61 974	9000 CD -94	
Antenna Kit	41 08 932	9000 CS 93- 9000 CD 95-	
• Mast	02 42 388	9000 CS 93- 9000 CD 95-	
• Bezel	02 51 207	9000 CS 93- 9000 CD 95-	

(See fiche for new 900 antenna)



Subject: Radio Accessories

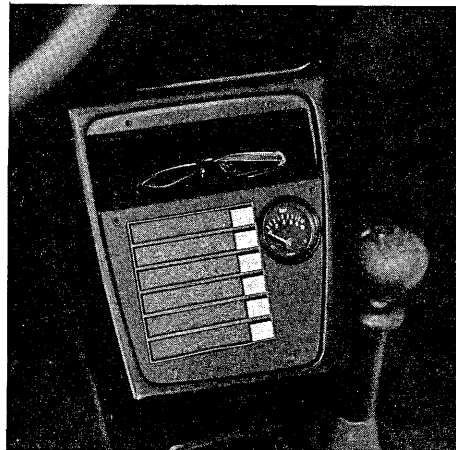
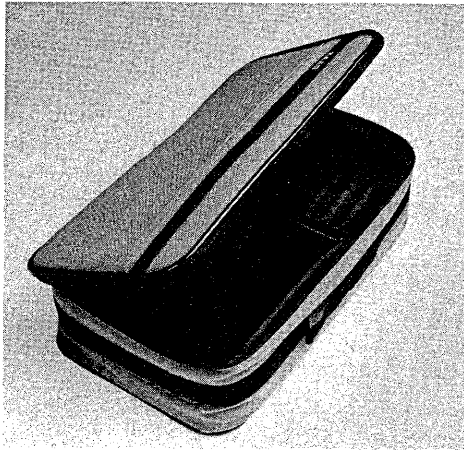

Description	Part Number	Application	Notes
Radio Carrying Case	02 73 136	900, 9000	For Saab-Clarion Removeable Radios
Cassette Storage Box	02 76 287	9000	Center Console
Cassette Storage Box	02 57 881	900 83-	Use with Center Console 02 58 269 or Original Center Console
Tape Deck Cleaner	02 45 720		
CD Autochanger cover	02 47 940	all	
Leather Case, Keypad	02 49 755	95- 9000	



Subject: 900 -93 (94 CV) Alarm Systems

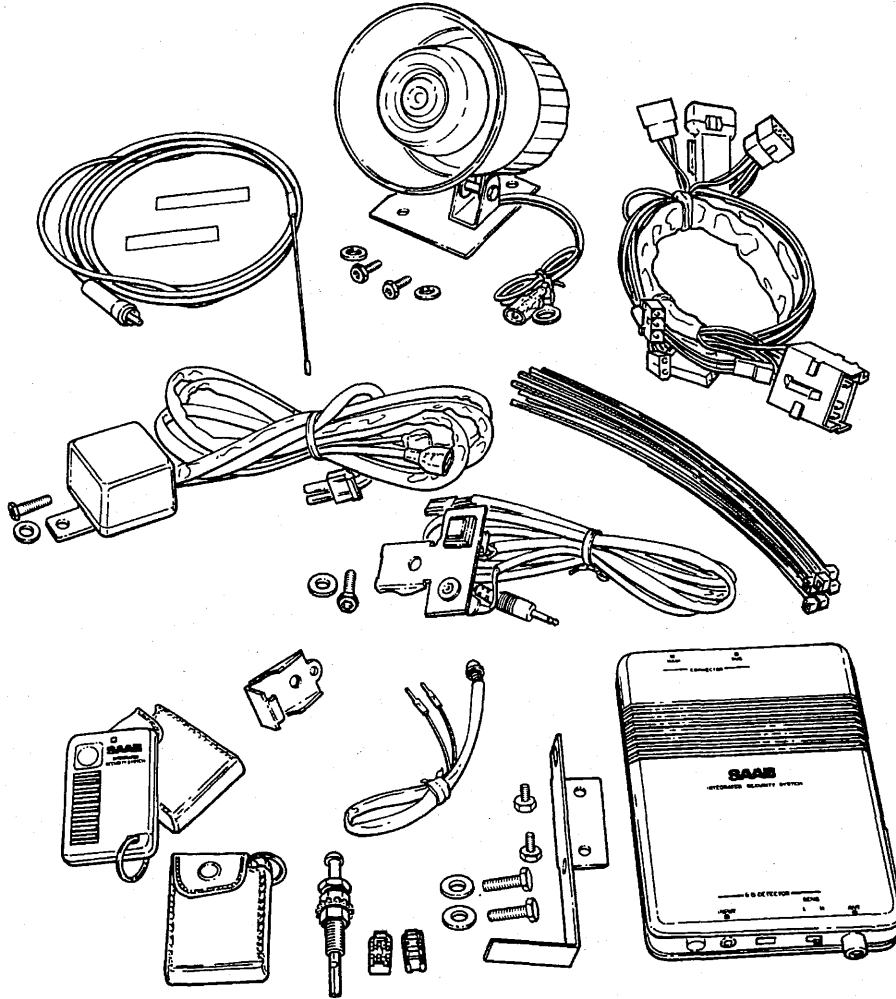

Description	Part Number	Application	Notes
"Saab-guard" alarm kit	02 70 496		-1990 Supercedes To 02 46 538
Alarm module kit	*02 46 512		(02 70 520) Replacement "Alpine" module
• Wiring harness	02 74 175		
• Remote shock detector	02 70 504		
• Hood switch	02 11 185		
• Horn/siren	02 11 169		
• Shock detector switch	02 11 193		
• L.E.D. dash light	02 70 488		
• L.E.D. bezel	02 74 183		
• Owners manual	02 74 191		
Remote disarm kit	02 11 201		(Discontinued)
Pocket pager kit	02 11 219		(Discontinued)

(continued next page)

**SAAB**

ACCESSORIES

Description	Part Number	Application	Notes
Antenna Relay	02 11 318		(Discontinued)
"Saab anti-theft" alarm kit	02 46 538		1990-91, 1991 CV 900
"Saab anti-theft" alarm kit	02 46 538		92-93, 94CV
• Alarm module	02 46 157		
• Alarm module bracket	02 46 272		
• Remote transmitter - Sony CR2025 battery	02 46 165		
• Remote transmitter pouch	02 46 215		
• Siren with bracket	95 98 541		
• Adapter wiring harness	85 48 539		Use with 95 98 541, -1991
• Wiring harness	02 46 181		
• Hood pin switch	02 46 223		
• LED with wire lead	02 46 231		
• Valet disarm switch	02 46 249		
• Glass breakage sensor	02 46 298		
• Valet switch/sensor bracket	02 46 264		
• Antenna	02 46 280		
• Installation screw kit	02 46 256		
• Owner's manual	02 46 306		
• Installation instructions	02 46 314		
Rom-chip kit	02 46 322		3 chips See SI 07/89-1157
Rom-chip kit	02 46 496		4 chips See SI 07/89-1157 Permits 3 transmitters
Siren Mounting Kit	02 46 454		91, 900 (Discontinued)



Subject: Fog Lights -93, 94 CV 900

①

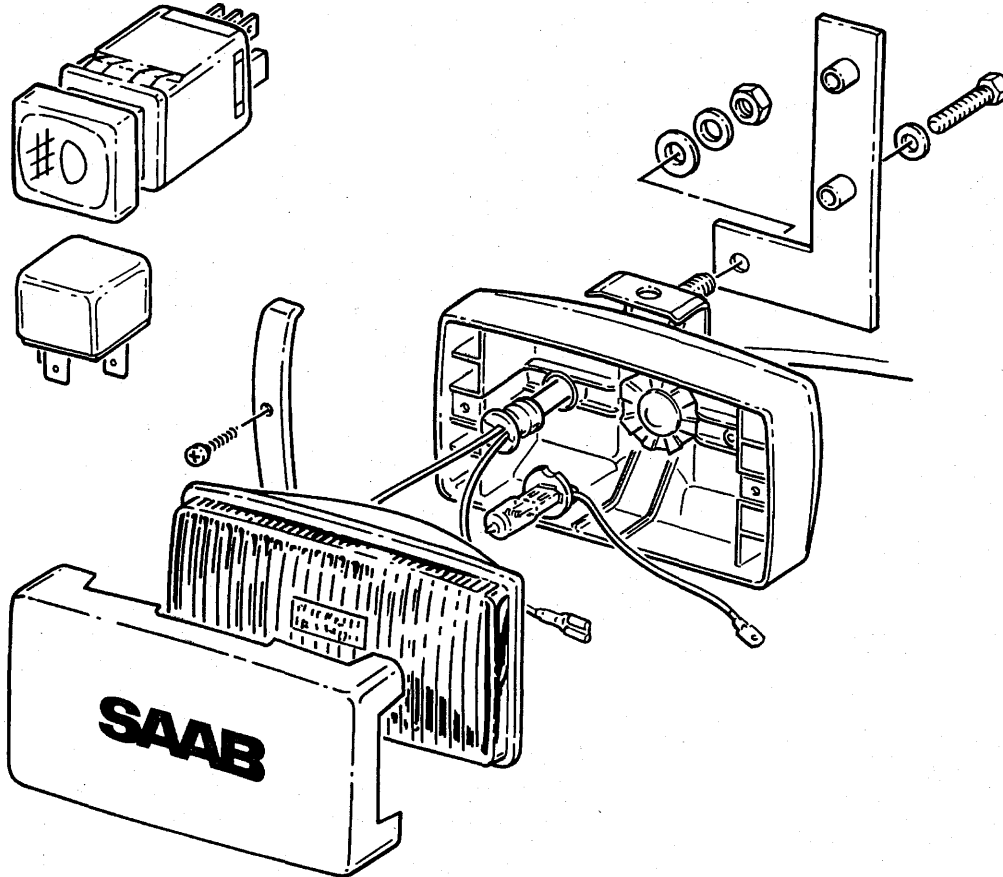

Description	Part Number	Application	Notes
Fog Light Kit	02 46 116	89-93, 94 CV	
• Fog Light Assy	02 46 389		
•• Lens/Reflector	02 80 560		
•• Lens Retainer/Clear	02 46 488		
• Lens Cover-Plain Black	02 46 066		
• Bulb H-3	85 29 109		
• Bracket, LH	02 46 413		New, longer design
• Bracket, RH	02 46 421		New, longer design
• Relay	85 22 310		
• Switch	95 23 762		
• Lamp Housing	02 46 371		
Lens/Reflector	02 46 397	Amber	Where required Alternative to 02 80 560
Lens Retainer	02 46 405	Amber	Use with 02 46 397

(continued next page)

**SAAB**

ACCESSORIES

Description	Part Number	Application	Notes
Fog Light Kit	02 46 116	900 87-88	For prewired M87-88 Cars. (Discontinued)
• Replacement Lamp	02 72 427		
• Lens/Reflector	02 80 560		
• Bulb H-3	85 29 109		
• Relay	85 22 310		
• Switch	95 23 762		
• Mounting Bracket-Left	02 46 413		
• Mounting Bracket-Right	02 46 421		
• Lens Cover-Plain Black	02 80 644		
Fog Light Kit	02 72 039	900 86	For pre-wired M86 Cars.(Discontinued)
• Replacement Lamp	02 72 427		
•• Lens/Reflector	02 80 560		
• Bulb H-3	85 29 109		
• Relay	85 22 310		
• Switch	95 23 762		
• Mounting Bracket-Left	02 72 419		
• Mounting Bracket-Right	02 72 401		
Wire Harness	02 72 310	(Discontinued)	Converts M83-85 pre-wired lamps to M86 style car wiring lamp to car harness.
Fog Light Kit	02 80 610	900 83-85 (Discontinued)	For pre-wired M83-85 Cars.
• Replacement Lamp	02 80 487		
• Lens/Reflector	02 80 560		
• Bulb H-3	85 29 109		
• Relay	02 80 495		
• Switch-fog light graphic	02 42 024		
• Mounting Bracket	02 80 461		Same bracket for left & right side.
• Lens Cover-Plain Black	02 80 644		
Fog Light Kit	02 80 453	900 79-82 (Discontinued)	Same spare parts as 02 80 610. For non pre-wired cars. Kit includes wiring harness.
Fog Light Kit	02 80 297	900 79-82 (Discontinued)	(Discontinued)
• Replacement Lamp	02 80 438		
• Bulb H-3	85 29 109		
• Relay	02 80 495		
• Lens Cover-Plain Black	02 80 446		
Fog Light Grille Guard	02 46 348	900 89 - 93, 94 CV	Individually Packaged.
Fog Light Grille Guard	02 80 628	900 79-88	Individually Packaged.
Lens Cover-Plain Black	02 80 644	EAG	No Logo
Amber Fog Lamp Lens/ Reflector	02 46 397	900 83 - 93, 94 CV	Alternative to 02 80 560
Amber Fog Lamp Lens/ Reflector	02 46 405	900 83 - 93, 94 CV	Use with 02 46 397
Above Bumper Bracket Kit	02 46 355	900 87 - 93, 94CV	

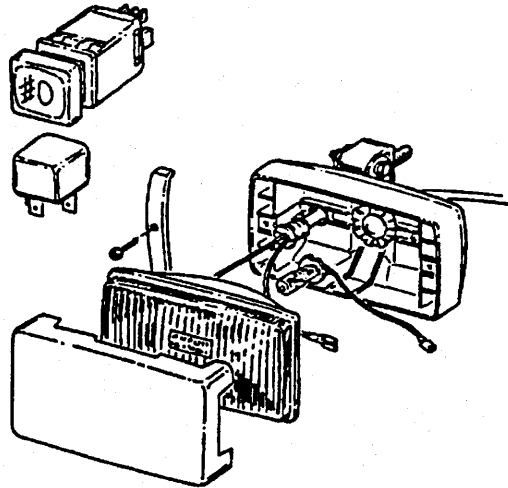
**Subject: 9000 Fog Lights**

Description	Part Number	Application	Notes
Fog Light Kit	02 46 678	9000 CS	Prewired Kit
Switch	40 85 577	9000 CS	Required for 9000 CS
Fog Light Kit, Bosch	02 46 132	9000 89-90 5 dr	Has clear lens/reflector retainers. Requires installation of fog light switch 95 23 762.
• Fog Light Assy	02 46 389		
•• Lens/Reflector	02 80 560		
• Lens Cover - Plain Black	02 46 066		
• Bulb H3	85 29 109		
• Bracket	02 46 090		Two Required
• Switch	95 23 762		
• Lamp Housing	02 46 371		
Fog Light Kit, Hella*	02 81 717	9000 89-94 4 dr 9000 91-92 5 dr	Kit for cars without O.E.M. foglights. Requires installation of fog light switch 95 23 762.
• Lens Cover-Saab Logo	02 43 022		
Fog Light Switch	95 23 762	9000 89-90 4 dr	Required with 02 81 717
Fog Light Kit, Bosch	02 46 132	9000 87-88	Complete Kit. Has black lens/reflector retainers.
• Replacement Lamp	02 72 427		
•• Lens/Reflector	02 80 560		
• Bulb H3	85 29 109		
• Switch	95 23 762		
• Mounting Bracket	02 46 090		Same for left and right side.
• Wire Harness	02 72 310		Lamp to car harness.
• Lens Cover - Plain Black	02 80 644		

* See parts microfiche for Hella fog light spare parts.

(continued next page)

**SAAB**

ACCESSORIES

Description	Part Number	Application	Notes
Fog Light Kit, Bosch	02 72 013	9000 86	Complete Kit (Discontinued)
• Replacement Lamp	02 72 427		
•• Lens/Reflector	02 80 560		
• Bulb H3	85 29 109		
• Relay	95 19 224		
• Switch	95 23 762		
• Mounting Bracket	02 46 090		Same for left and right side.
• Wire Harness	02 72 310		Lamp to car harness.
• Lens Cover - Plain Black	02 80 644		
Fog Light Grill Guard, Bosch	02 46 348	9000 89-90 5 dr	Individually packaged
Fog Light Grill Guard, Bosch	02 80 628	9000 86-88 5 dr	Individually packaged
Amber Fog Lamp Lens/ Reflector, Bosch	02 46 397	9000 86-	Alternative to 02 80 560
Amber Lens Retainer, Bosch	02 46 405		Use with 02 46 397
Above Bumper Bracket Kit	02 46 355	9000 All	



Subject: Airflow Fog Light Kit



Description	Part Number	Application	Notes
Fog Light, Complete Kit	02 81 717	9000, 900	Clear Lens Only
• Fitting Kit	02 75 578	900 -1986	For Mounting 02 81 717 in Earlier Airflow Kit 00 26 989 (900 -86) 55 WATT
• Bulb, H-3	85 29 109		
• Cover, "SAAB" Logo	02 43 022		
• Replacement Lamp Assy	95 29 900		
• Flanged Mounting Nut	73 98 423		
Also Required for installation on Indicated Models			
Fog Light Relay	85 22 310	900 83-	
Fog Light Relay	95 19 224	9000	
Fog Light Switch	02 42 024	900 83-85	
Fog Light Switch	95 23 762	9000 900 86-	
CD Adapter Kit	02 44 947	9000 CD	



Subject: Speed Control Kits 900 -93, 94 CV

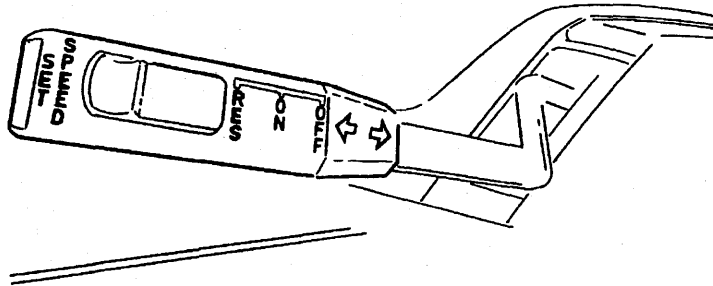

Description	Part Number	Application	Notes
Speed Control Kit	02 44 681	900 89-91	
ABS Pedal Bracket	44 28 348	900 90-	Required for installation of 02 44 681 in M90.
Speed Control Kit	02 43 873	900 89-	Replaced by 02 44 681. Requires wiring harness 02 43 881. See parts fiche for spare parts. See S.I. 01/89-1109 Sec. A-9, p. 75.
Speed Control Kit	02 45 530	900 92-93, 94CV	
Vacuum Pump Wire Harness	02 71 221	900 86 (Discontinued)	Qty 1 required for installation of 02 06 359 in M86
Fuse Box Connector	91 20 783	900 86	Qty 1 required for installation of 02 06 359 in M86



Subject: Spare Parts 900 1979 - 83 Speed Control Kits

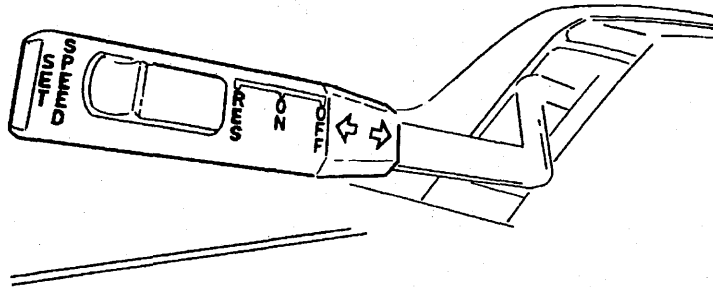

Description	Part Number	Application	Notes
Spare Parts			For Kit 02 05 245 02 06 300 02 06 318
Regulator Assembly (black)	02 05 252		
Regulator Assembly (yellow)	02 05 575		Part of 02 06 318
Servo Assembly	02 05 260		
Engage Switch	02 05 278		
Disengage Switch	02 05 286		
Disengage Switch	02 05 583		Part of 02 06 318 two per kit
Decel Switch	02 05 294		
Wiring Harness	02 05 302		
Wiring Harness	02 05 641		Part of 02 06 318
Throttle Lever	02 05 328		
Coil Bracket	02 05 344		
Vacuum Reservoir	02 05 369		
Bracket	02 05 237		
Wire Retainer	02 05 385		(Discontinued)
Chain	02 06 219		
Bracket, Brake Pedal	02 05 591		Part of 02 06 318
Actuator, Brake Pedal	02 05 609		Part of 02 06 318
Bracket, Clutch Pedal	02 05 617		Part of 02 06 318
Actuator, Brake Pedal	02 05 625		Part of 02 06 318
Tee Connector	02 05 633		



Subject: Cruise Control Kit 9000

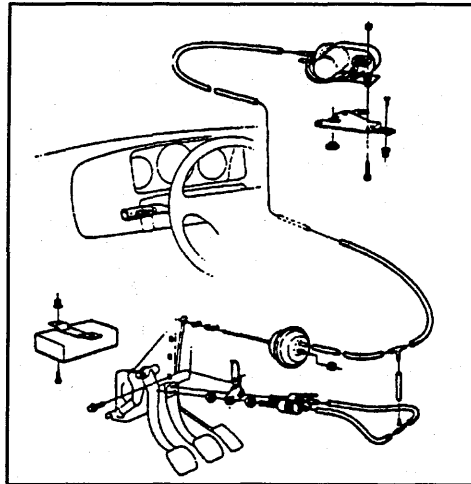

Description	Part Number	Application	Notes
Cruise Control Kit	02 45 100 02 45 522	9000 91 9000 92	

For spares see parts microfiche.

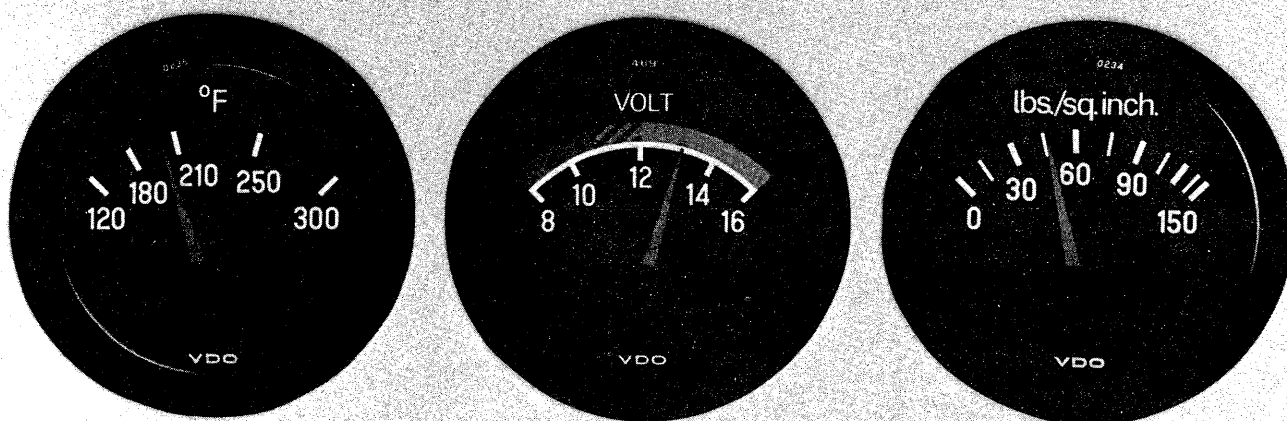
**Subject: Instrument Gauges**

Description	Part Number	Application	Notes
Outside Temperature Gauge	02 74 159	900 -93, 94CV, 9000	
Sender	02 71 106		
Voltmeter	02 74 134	900 -93, 94CV, 9000	(Discontinued)
Oil Pressure Gauge	02 74 142	900 -93, 94CV, 9000	Replaces 02 71 015
Oil Pressure Sender	02 75 289		For 02 74 142
Oil Pressure Sender	02 71 072		150 lb. Calibration. Used for 02 71 015.
Oil Pressure Sender Adapter Gasket	02 71 304 81 24 141		Use when mounting 02 71 015 Kit in 85- 900, 9000.
Oil Temperature Sender for oil temperature gauge	02 71 080		

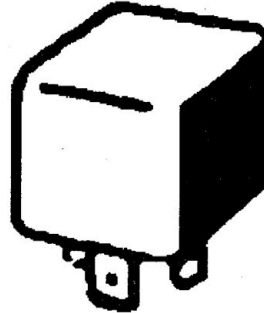
**Subject: Relays**

Description	Part Number	Application	Notes
Door Chime Relay	95 63 313	900, 86-88	
Door Chime Relay	95 67 017	900, 84-88	
Daytime Running Lights Relay	95 56 390	9000, 91-92 5D 91-94 CD	



Subject: DCC Trip Computer

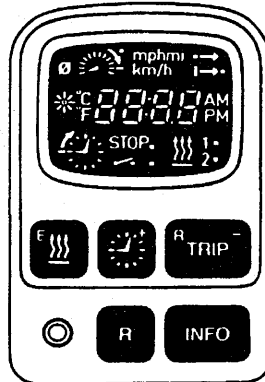

Description	Part Number	Application	Notes
Driver/Co-driver Computer Kit	85 47 952	9000 1990-91	Cars are prewired for DCC. Order Installation Instructions and Owners Manual separately.
Driver/Co-driver Computer Kit	02 42 347	9000 1992-94	
SCC Computer Kit	45 19 443	9000 95-	
Driver/Co-driver Computer Kit	85 47 358	9000 1986-89	NOTE: 1990- cars require reprogramming of the EDU with the ISAT special tool at the time of installation. Cars are prewired for DCC. Order Installation Instructions and Owners Manual separately.
Owner's Manual	02 89 777	1986-	
Installation Instructions	02 89 819	1986-89	
Installation Instructions	06 70 224	1990-	



Subject: Mobile Cellular Phone 91 9000 CD

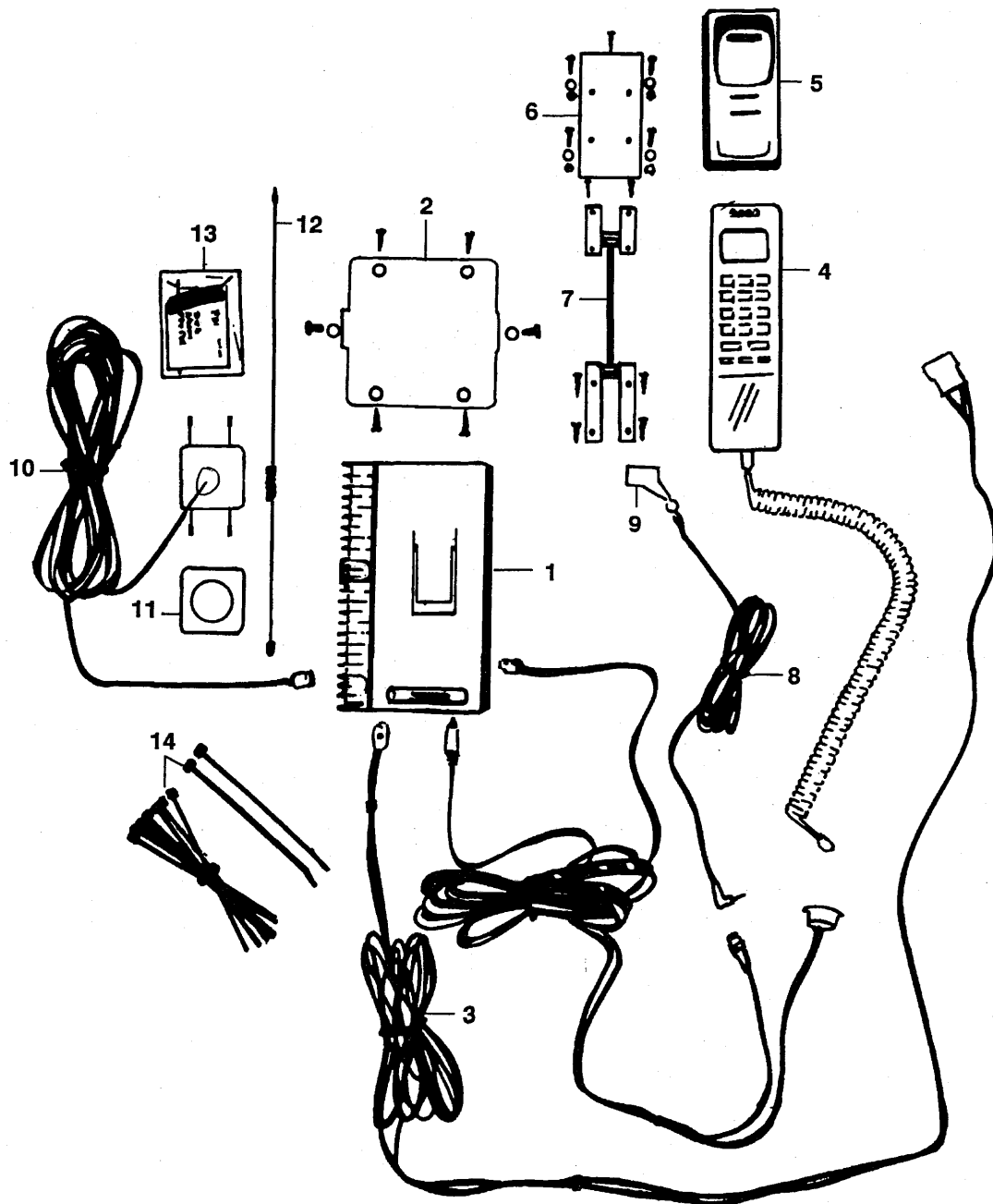

- | | | |
|---|---|--|
| 1. Transceiver | 6. Handset mounting plate with hardware | 10. Internal antenna coupling box (with cable) |
| 2. Transceiver mounting bracket with hardware | 7. Handset hinge arm with hardware | 11. External antenna base |
| 3. Power cable | 8. Hands Free (HF) microphone cable | 12. Antenna whip |
| 4. Handset | 9. Hands Free (HF) microphone | 13. Antenna mounting cleaning kit |
| 5. Headrest cradle | | 14. Tie straps |

**SAAB**

ACCESSORIES

Description	Part Number	Application	Notes
Installation Manual	02 47 270		1)
Owners Manual	02 47 288		1)
Warranty Registration Cards	02 47 296		1)
Quick Reference Cards	02 47 304		1)
M11-TXE Transceiver	02 47 320		
MTX Handset	02 47 338		1)
Power Cable	02 47 346		4200 mm long
Data Cable	02 47 353		
Antenna Mast	02 47 361		1) (Discontinued)
External Antenna Mount	02 47 379		
Internal Antenna Mount	02 47 395		1) With Cable
Mounting Bracket	02 47 403		
Mounting Bracket Hardware	02 47 411		
Handset Pedestal	02 47 429		
Handset Pedestal Hardware	02 47 437		
Handset Cradle	02 47 445		
Handset Cradle Mounting Plate	02 47 452		
Handset Cradle Hardware	02 47 460		(Discontinued)
Hands free Microphone	02 47 478		With cable
Hands free Microphone Clip	02 47 486		
Data cable hardware set	02 47 569		
Data cable jack	02 47 577		(Discontinued)

1) Included in "Dealer Customer Service Repair Kit."

**Subject: Portable Cellular Phone, Spare Parts 92 9000 Griffin**

See illustration on following page.

Description	Part Number	Application	Notes
P4000 hand portable	02 47 718		(Discontinued)
Handset cradle	02 47 817		
Handset cradle hardware	02 47 833		(Discontinued)
Power cable	02 47 726		
Data cable	02 47 734		
Handsfree interface box/power supply/charging box	02 47 866		
Handsfree speaker	02 47 874		
Handsfree microphone	02 47 478		
Handsfree microphone clip	02 47 486		
Handset pedestal	02 47 791		(Discontinued)
Handset pedestal hardware	02 47 809		(Discontinued)
Interface mounting bracket	02 47 783		
Interface mounting bracket hardware	02 47 775		
Overnight charging stand	02 47 882		
AC adapter	02 47 890		
Saab owners manual	02 47 684		(Discontinued)
Warranty registration cards	02 47 692		
Antenna mast	02 47 742		
External antenna mount	02 47 759		(Discontinued)
Internal antenna mount	02 47 767		With Cable

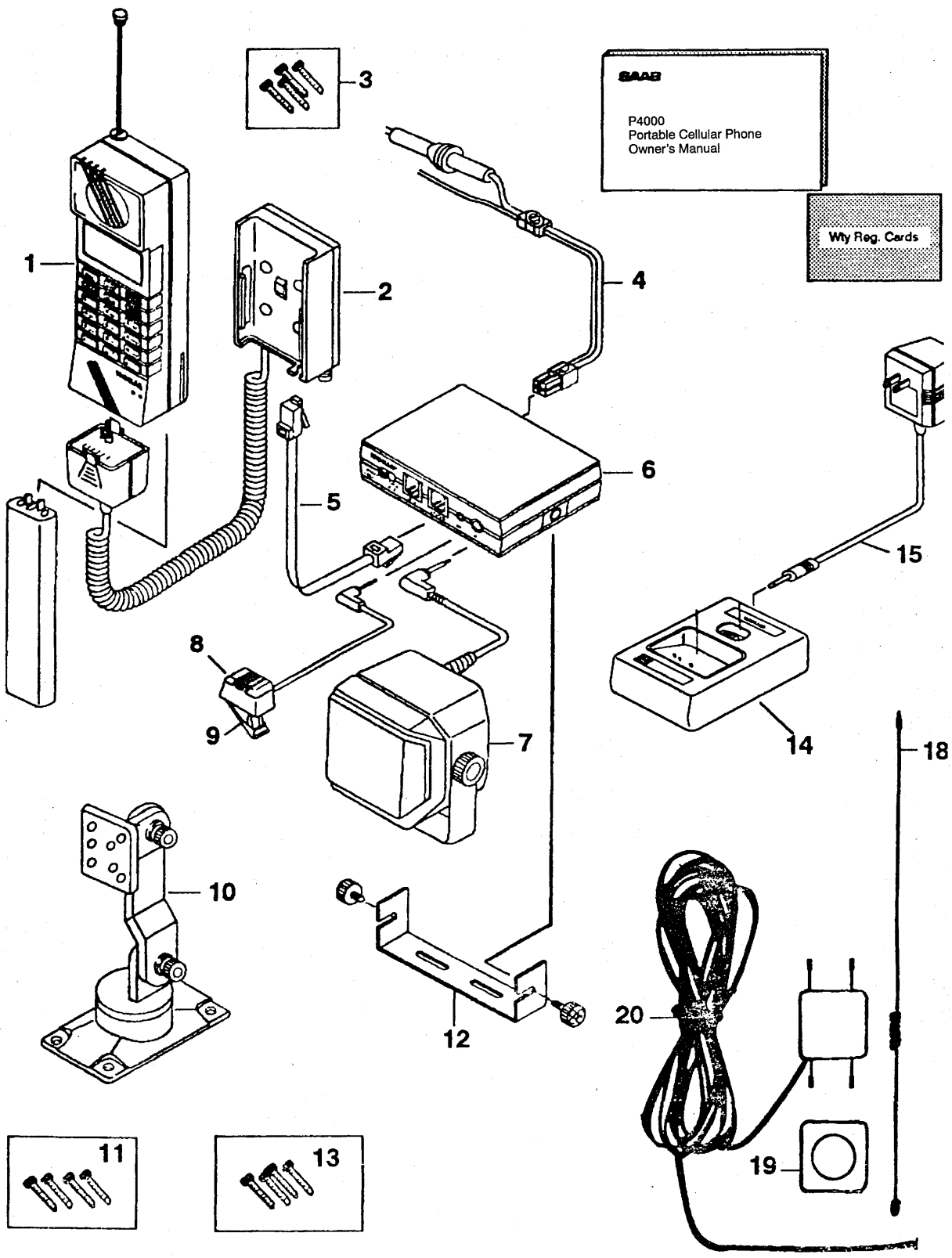



Subject: Mobile Telephone Accessories

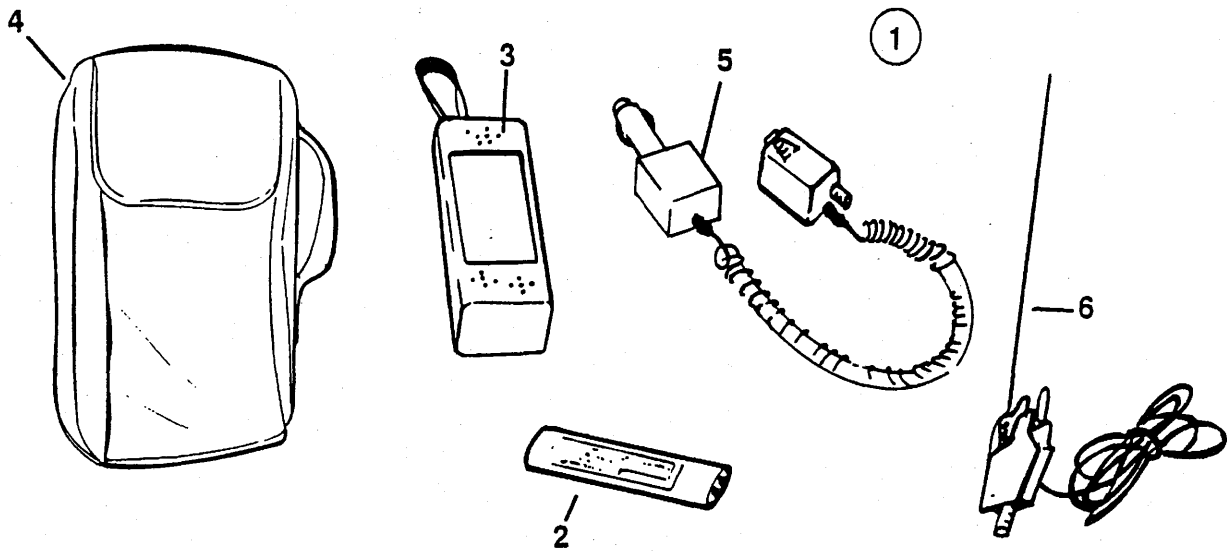

Description	Part Number	Application	Notes
Road Kit	02 47 908		Use with P4000 phone
• Battery	02 47 916		
• Phone case	02 47 924		Use with P4000, leather
• Carrying bag	NPN		
• Adapter cable	NPN		
• Mobile antenna	NPN		
Mounting Console	02 48 849		900 94-
Telephone Connector	02 48 666		900 94-
Telephone Connector	02 48 658		9000 89-
Cell Phone Mount and Cradle	02 50 530		All
Cellular patch antenna	02 51 470	900 All, 9000 All	For use with portable cellular phones.



Subject: Sport Steering Wheel

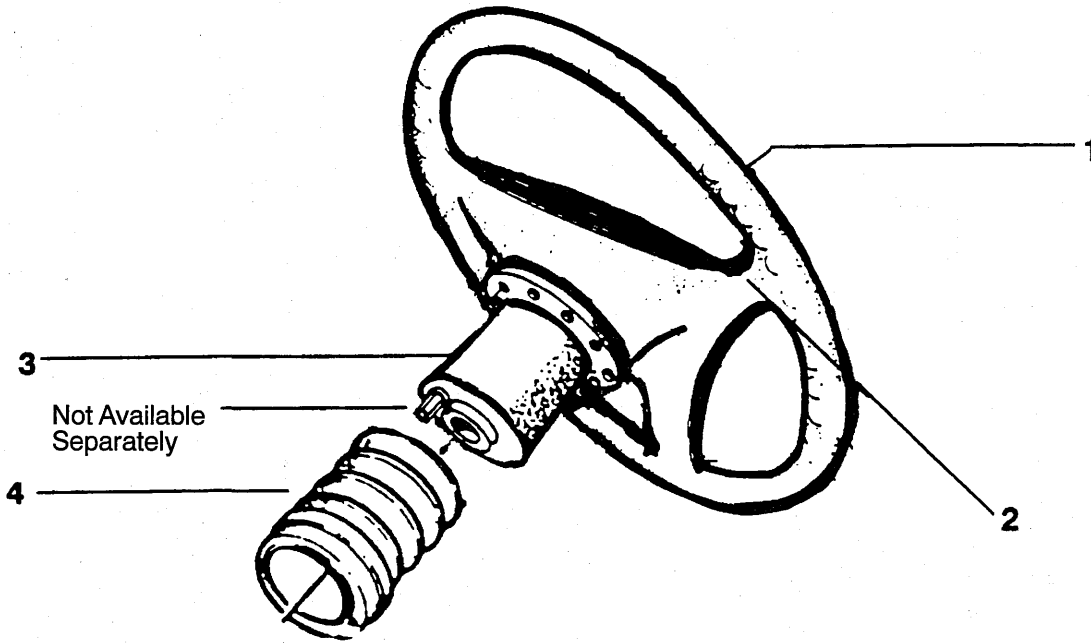

Description	Part Number	Application	Notes
Steering Wheel	02 43 709		Leather (Discontinued)
• Horn Contact	02 70 637		
Hub	02 43 717		9000
• Gaiter w/horn contact	02 76 022		9000 (Discontinued)
Hub	02 45 944		900
• Gaiter w/horn contact	02 70 645		900 (Discontinued)

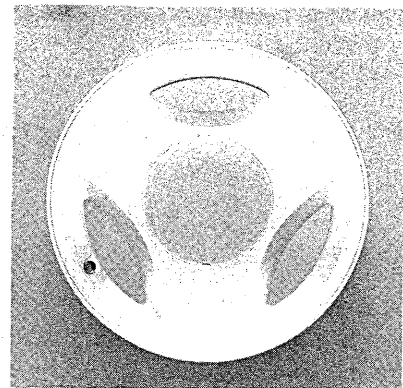
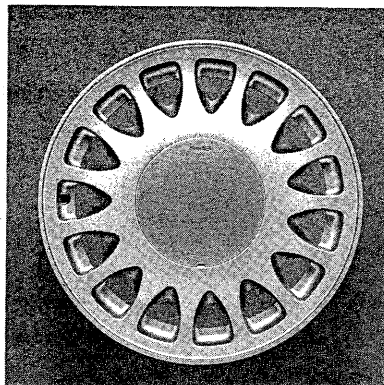
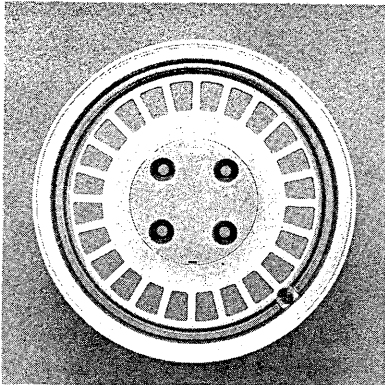
**Subject: Accessory Wheels, 900 -1987**

Description	Part Number	Application	Notes
SPG 3 Spoke 5.5 x 15	89 85 970	900 81-87	
Center Cap	89 85 996		Not included with wheel.
Turbo 15 Spoke 5.5 x 15	91 00 587	900 81-87	
Center Cap	02 81 535		Not included with wheel.
Light Alloy - 5.5 x 15	00 24 489	900 81-87	
Hubcap	89 85 483		Not included with wheel.
Lug Nut	89 47 277	900 81-87	With alloy wheels above.
Inca/Turbo Alloy 5.5 x 15	00 22 343	99, 78, 900 79-80	Standard on 3 door Turbo. (Discontinued)
Nut	02 05 021		Not included with wheel.
Cap-Emblem	00 22 483		Not included with wheel.
TRX Alloy Wheel 135mm x 390mm	02 11 334	900 79-81	(00-22-970) Note metric sizes. Must be fitted with metric tire size
Nut	89 47 277		Use with 02 11 334.
Nut	02 05 021		Use with 00 22 970.
Hubcap	00 24 133	900 79-81	Not included with wheel.



Subject: Accessory Alloy Wheels, 900 -1987

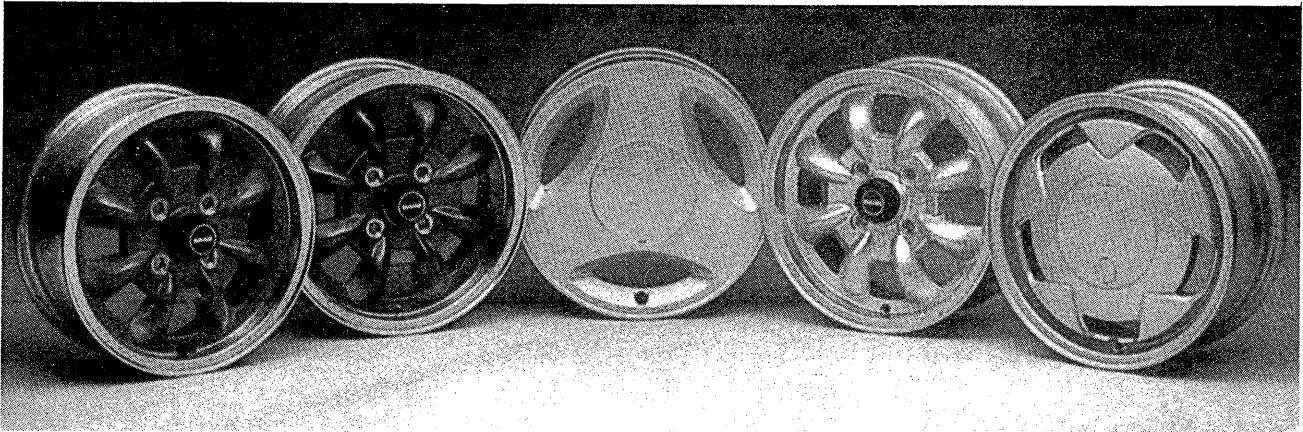

Description	Part Number	Application	Notes
Super Inca 6 x 15	02 70 801	900 81-87	To avoid any wheel arch rubbing, it is recommended that the springs & shocks kit (PN 02 74 589) be used in conjunction with 6" wheels.
Lug Nut	89 47 277		
Center Cap Locking	02 05 500		
Shelby Goldvane 5.5 x 15	02 05 401	900 81-87	(Discontinued)
Shelby Silvervane 5.5 x 15	02 05 393	900 81-87	(Discontinued)
Lug Nut	02 05 021		Packaged with wheels 02 05 401 and 02 05 393.
Ronal Sport 5.5 x 15	00 24 380	99, 900-1987	(Discontinued)
Lug Nut	89 47 277		Not included with wheel.
Hub Cap Emblem	00 22 483		Not included with wheel.
Silver Star 5.5 x 15	02 05 484	900 81-87	(Discontinued)
Lug Nut	89 47 277		Not included with wheel.
Center Cap Non-locking	02 70 108		Not included with wheel. (Discontinued)
Center Cap Locking	05 05 500		Not included with wheel.
Super Inca 5.5 x 15	02 70 090	900 81-87	
Lug Nut	89 47 277		Not included with wheel.
Center Cap Non-locking	02 70 108		Not included with wheel. (Discontinued)
Center Cap Locking	02 05 500		Not included with wheel.

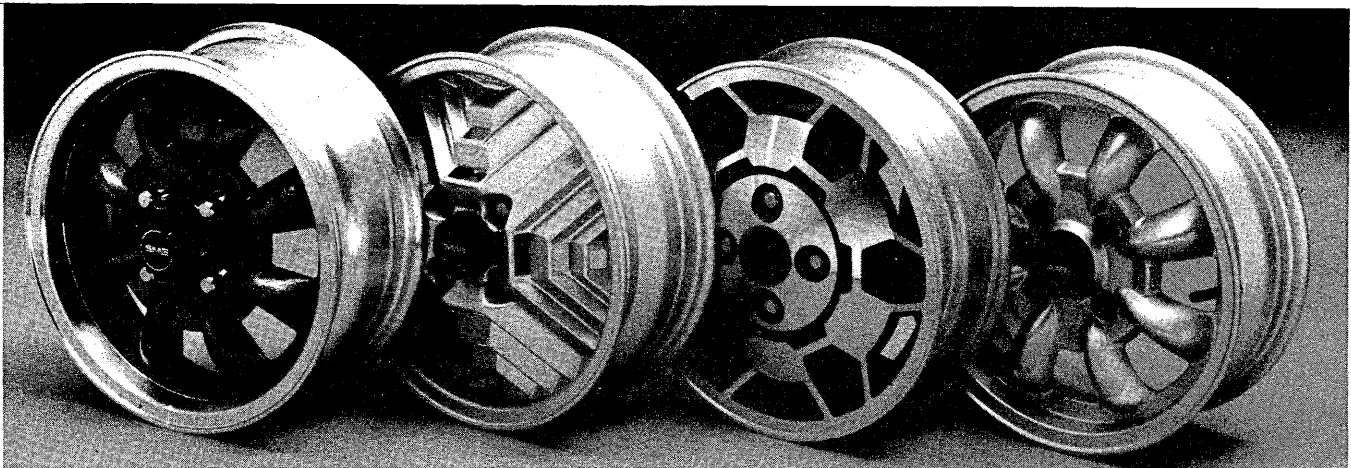
**Subject: Alloy Wheels Early Cars**

Description	Part Number	Application	Notes
Spoked Alloy Wheel 5 x 15	00 23 820	95, 96, 97	"Minilite" Appearance (Discontinued)
Lug Bolt	00 23 960		
GLE "Gold" Wheel	00 17 772	99	(Discontinued)
Nut	02 05 021		Not included with wheel.
Cap-Emblem	00 22 327		Not included with wheel.
EMS Wheel 5 x 15	00 22 319	99, 900	(Discontinued)
Nut	02 05 021		Not included with wheel.
Cap-Emblem	00 22 327		Not included with wheel.
Alloy Wheel Weights	30 20 898		Box of weights.



Subject: Hubcaps and Wheel Covers

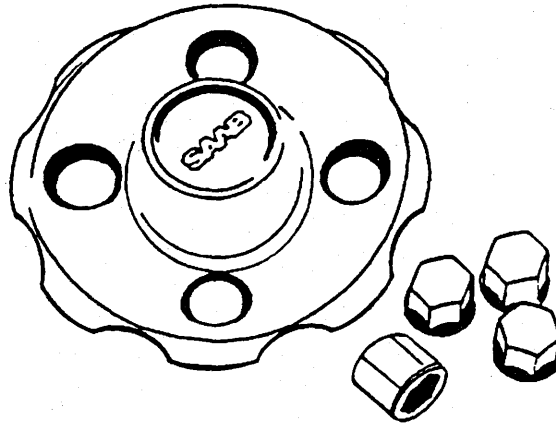

Description	Part Number	Application	Notes
Silver polyamid plastic	45 45 729	85-All	Fits steel wheels. (Single hub cap)
Silver polyamid plastic	89 72 663	900 -M93, 900 Convertible -M94, 9000 M86	Fits steel wheels. (Single hub cap)
Silver polyamid plastic	02 49 367	900 -M93, 900 Convertible -M94, 9000 M86	(Set of 4)
Longer Spoke	02 49 854	900 88- All 9000	Fits steel wheels. (Set of 4)
Longer Spoke	45 43 567	900 88- All 9000	(Single hub cap)
Center Hub Covers	02 73 482	900 88-, 9000	For steel wheels. Black plastic center hub covers - set of four.
• Wheel nut sleeves	02 75 271		Pack of 20.
Center Hub Covers	02 73 474	900 79- 87	For steel wheels. Black plastic center hub covers - set of four.
• Wheel nut sleeves	02 75 271		Pack of 20.
EV-1 Wheel Covers Single Cover	02 74 654		
Clips/Set of 8	02 43 154		
Saber Style Wheel Cover	89 72 812	900 85-, 9000 86-	Fits 5 1/2" steel wheel.
Wheel Cover Clip Set	89 73 422		5 per bag (enough for one wheel cover). Use with 89 72 812.
Wheel Cover Clip Set	91 00 207		24 per bag. Use with 89 87 604.
Individual Clip	91 01 502		
GLE Style	89 47 293	900 82- 84	Use with 5 1/2" rim 89 46 774.
18 Spoke wheel cover	02 51 132	900 94-3D/5D, 95-CV	(Set of 4)
18 Spoke wheel cover	02 51 123	900 3D/5D 94-, CV 95-	(Single)
Wheel Bolt Caps	02 51 264	900 3D/5D 94-, CV 95-	Black plastic caps fit over wheel bolts to enhance appearance when wheel or wheel cover of exposed bolt design is used.



Subject: 900 Wheels

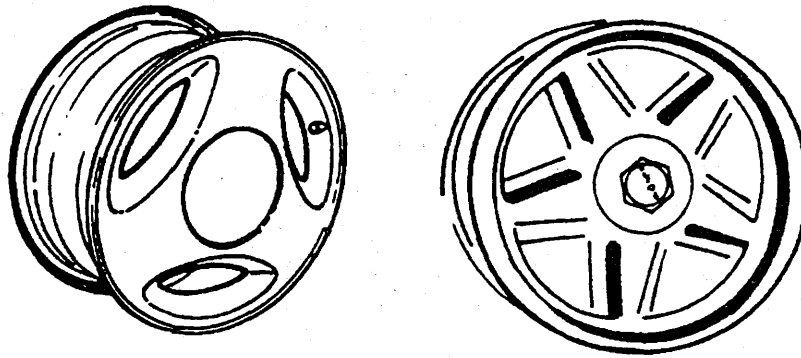

Description	Part Number	Application	Notes
Long spoke 6 x 15"	42 41 642	900 M94-96	Not 94 CV.
Hub cap	44 25 476	900 M94-96	Not 94 CV.
Seven-spoke 6 x 15"	02 48 856	900 M94-	Not 94 CV.
Hub cap	02 48 963	900 M94-	Not 94 CV.
Viking Aero 6 1/2 x 16"	42 41 667	900 M94-96	Not 94 CV.
Hub cap	41 99 980	900 M94-96	Not 94 CV.
Aero 92, 5 1/2 x 15			
Left	40 04 750	900 M88-93, 94 CV	
Right	40 04 743		
Hub cap	44 25 476		
Mid-spoke 6 x 15"	02 48 864	900 M88-93, 94 CV	
Hub cap	44 25 476		
Super Aero 6 1/2 x 16"	44 67 254	900 M94-	Not 94 CV.
Hub cap	44 25 476		
3 Spoke 6 1/2 x 15"	45 66 048	900 M94-	Not 94 CV.
Blue Logo Center Cap	45 66 311	900 M94-	Not 94 CV.
Silver Center Cap	46 48 424	900 M94-	Not 94 CV.
Viking 6 1/2 x 16"	46 48 028	900 M94-	Not 94 CV.
Blue Logo Center Cap	45 66 311	900 M94-	Not 94 CV.
Silver Center Cap	46 48 424	900 M94-	Not 94 CV.
Y-Spoke 6 1/2 x 16"	02 51 165	900 M94-	Not 94 CV.
Blue Logo Center Cap	45 66 311	900 M94-	Not 94 CV.
Silver Center Cap	46 48 424	900 M94-	Not 94 CV.
Seven-Spoke, Bugatti-style	02 51 199	900 M94-	Not 94 CV.
Blue Logo Center Cap	45 66 311	900 M94-	Not 94 CV.
Silver Center Cap	46 48 424	900 M94-	Not 94 CV.

(See Accessories/Wheel brochures for illustration)

(continued next page)



SAAB

ACCESSORIES

Subject: 900 Wheels

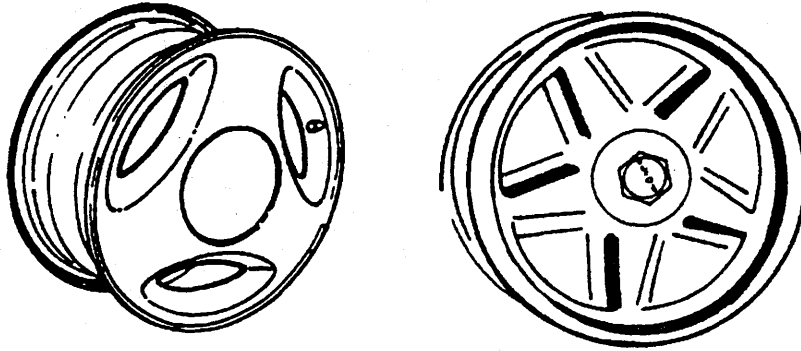

Description	Part Number	Application	Notes
Super Inca wheel	02 81 691	88-93, 94CV	6 x 15
Inca center cap	02 70 108		6 x 15 (Discontinued)
Super Inca wheel	02 81 527	88-93, 94CV	5.5 x 15
Inca center cap	02 81 535		5.5 x 15
Locking Inca center cap	02 05 500		set o 4 5.5 x 15
Ronal R15 wheel	02 44 665	88-93, 94CV	6.5 x 15
Locking center cap	02 50 340		With 2 keys
Diamond spoke wheel	02 43 121	88-93,94CV	6 x 15 (Discontinued)
Center cap	02 81 535		
Silver spoke wheel	02 43 337	88-93,94CV	6 x 15
Center cap	00 22 483		
Locking wheel bolt set	02 44 400	-93,94 CV	Set of four
Socket wrench	02 44 756		
Locking wheel bolt set	02 48 625	94-900	



Subject: 9000 Wheels

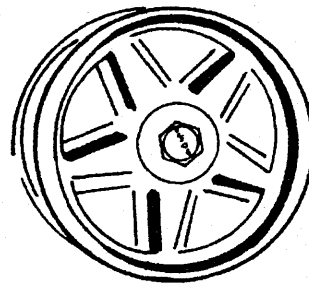
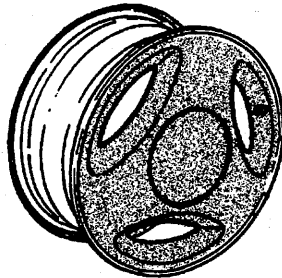
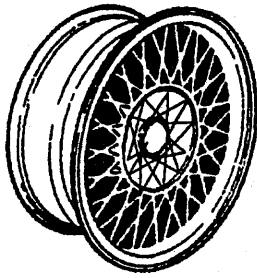

Description	Part Number	Application	Notes
Super Aero 6 ¹ / ₂ x 16"	44 25 310	9000 M86-	
Hub cap	44 25 476		
Aero 92, 6 x 15"		9000 M86-	
• Left	40 04 735		
• Right	40 04 727		
Hub cap	44 25 476		
Mid-spoke 6 x 15"	02 48 864	9000 M86-	
Hub cap	44 25 476		
Five spoke 94, 7 x 15"	02 42 412	9000 M86-	
Replacement center cap	02 48 344		
New cross-spoke 7 x 15"	02 51 157	9000 M86-	
Center Cap	02 51 124	9000 M86-	
Center Cap Removal Tool	02 51 140	9000 M86-	
Eight Spoke 6 x 15	46 47 475	9000 M86-	
Blue Logo Center Cap	45 66 311	9000 M86-	
Silver Center Cap	46 48 424	9000 M86-	

(See Accessory/Wheel brochure for illustration)

(continued next page)

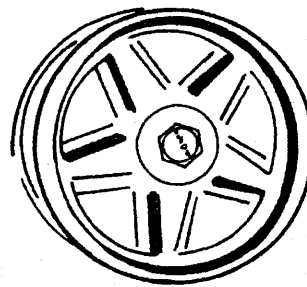
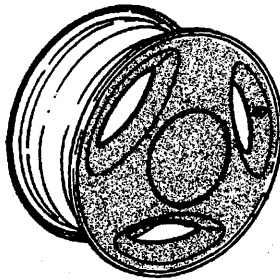
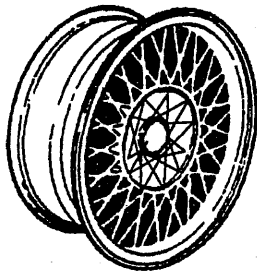
**SAAB****ACCESSORIES****Subject: 9000 Wheels**

Description	Part Number	Application	Notes
Cross-spoke wheel and tire set	02 70 967		Set of four (Discontinued)
• Cross-spoke wheel	02 74 688		6.5 x 16
•• Cross-spoke hubcap	02 70 900		
• Pirelli P700 tire	02 49 433		205/50 VR 16
Locking center cap set	02 43 048		With 02 70 967
Aero wheel and tire set	02 44 764		(Discontinued)
• Aero wheel	89 67 036		6.5 x 16
• Center cap	89 73 018		
• Pirelli P700 tire	02 49 433		205/50 VR 16
Ronal R15 wheel	02 44 665		6.5 x 15
Super inca wheel	02 81 691		6 x 15
Locking inca center cap	02 05 500		Set of 4, 5.5 x 15
Diamond spoke wheel (Discontinued)	02 43 121		6 x 15
Center cap	02 81 535		
Silver spoke wheel	02 43 337		6 x 15
Center cap	00 22 483		
Locking wheel bolt set	02 44 400		Set of four
• Socket wrench	02 44 756		
Super CS Wheel	46 47 475		
Hub Cap	46 48 424		

(See Accessory/Wheel brochure for illustration)



Subject: Snow Tires



Description	Part Number	Application	Notes
Mounted Gslaved Nord-Frost	02 49 771	9000, 900 88-93, 94CV	5.5" Wheel
Mounted Gslaved Nord-Frost	02 51 181	9000, 900 88-93, 94CV	6" Wheel
Unmounted Gslaved Nord-Frost	02 49 763	All	
Mounted Gslaved Nord-Frost	02 49 904	900 94-	



Subject: Handling Kits 900

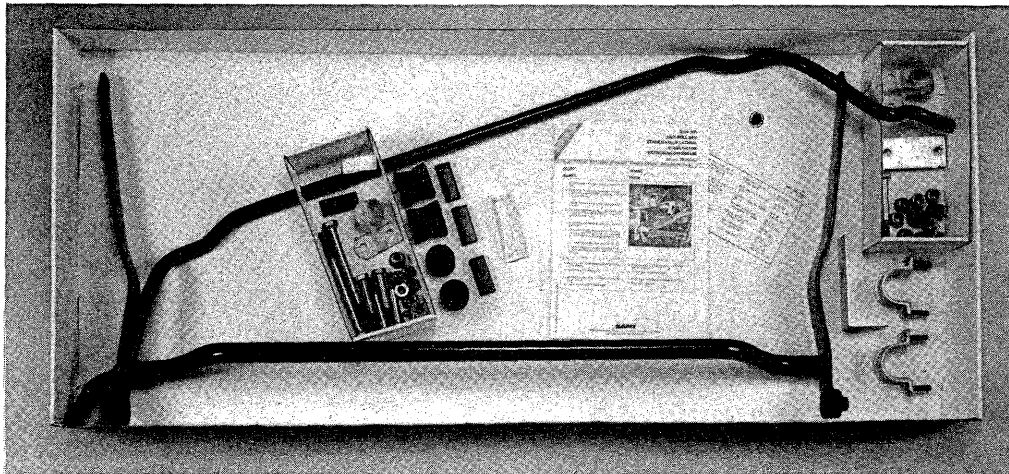

Description	Part Number	Application	Notes
Sway Bar Kit	00 26 542	900 79-93, 94CV	Spare Parts available on Parts Microfiche
• Grease	00 26 575		
Springs and Shocks Kit	02 74 589	900 79-93, 94CV	Kit contents is the same equipment as found as original equipment on M87 SPG.



Subject: Handling Kits 9000

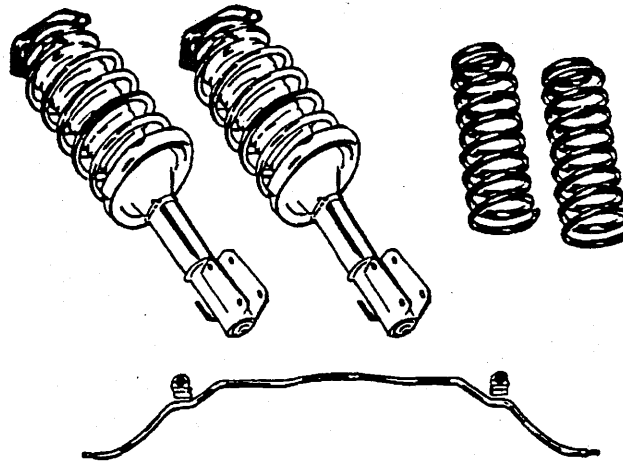

Description	Part Number	Application	Notes
Strut and Spring Kit	02 43 204		1) (Discontinued)
• Front strut assembly	89 67 838		(Discontinued)
• Rear Spring	89 69 016		
Front anti-sway bar kit	02 43 212		1)
Rear supplemental kit	02 44 582		1) (Discontinued)
• Rear shock absorber	89 68 570		
• Anti-sway bar	89 61 765		

1) 1990- Except 1991 + 1992 5DR Turbo. All three kits required.

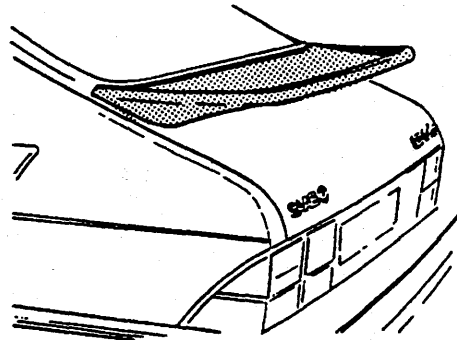
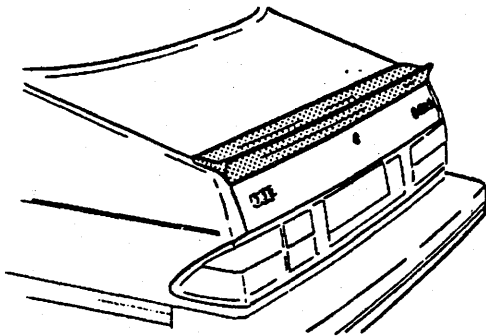
**Subject: Rear Spoilers 900 -93, 94CV**

Description	Part Number	Application	Notes
Whale-Tail Spoiler	02 70 975	900 3CK -93, 94CV	Replaces 02 74 944. Same location as 3CK O.E. Turbo spoiler.
• Gas Shock	92 93 580	900 3CK NonTurbo	
Turbo Spoiler	78 73 789	900, 99, 3CK -93	3 and 5 door cars. Original equipment material includes mounting hardware.
4 SN Spoiler	78 74 381	900 4SN -93	4 door sedans only. Original equipment on Anniversary car. Spare parts found on microfiche.
Air Outlet Cover Set	02 71 155	900 79-93, 94CV	



Subject: Front Spoilers 900 -93, 94CV 9000 -90

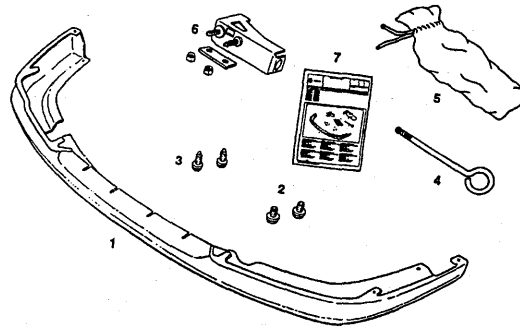

Description	Part Number	Application	Notes
Black 900 Kit	00 24 232	900 All, -93, 94CV	(Discontinued)
• Mounting Kit	00 24 257		Use with 00 24 232. Not part of kit.
Front Spoiler	02 44 434	9000 -90	



Subject: 9000 CS Spoilers

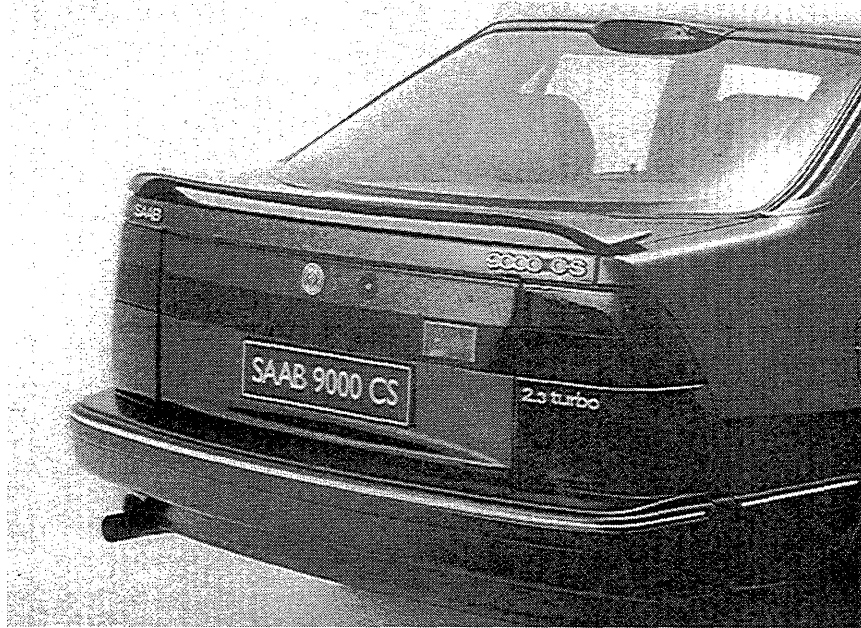

Description	Part Number	Application	Notes
9000 CS Spoiler	82 85 314		(Standard on Turbo)
9000 CS Bridge Spoiler	02 49 672		
Cover Strip Kit	02 45 670		Required for use on models with OE Spoiler
Gas Springs	43 06 411		(Order Qty 2) Required for models not equipped with OE spoiler



Subject: Rear Spoilers 9000

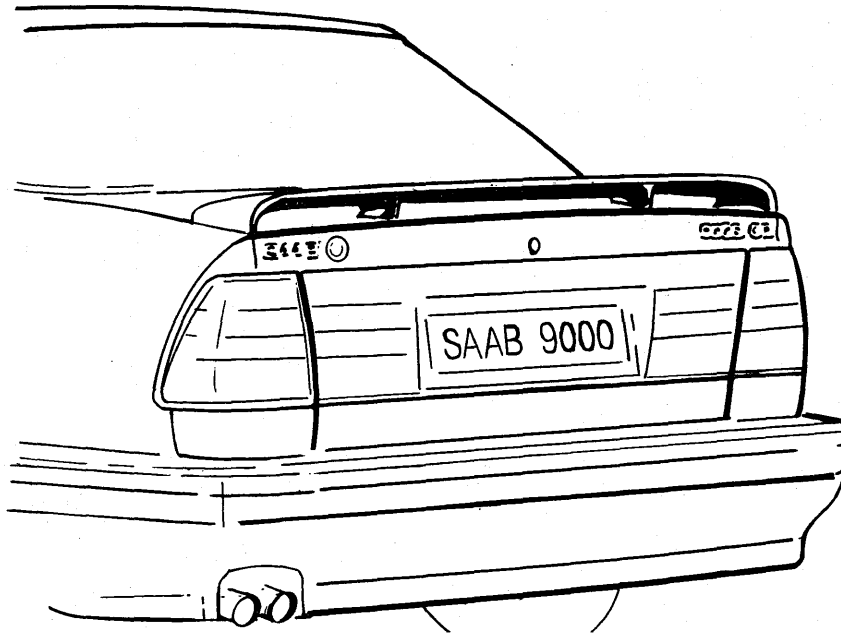

Description	Part Number	Application	Notes
Rear Deck Spoiler-Bridge style	02 44 723	9000 4 door	Can be painted to match the car.
Original Equipment Rear Spoiler	82 84 275	9000 5 door Turbo	
• Spoiler	69 92 838		
• Mounting Kit	82 84 267		
• Gas Strut	69 56 288		
Original Equipment Rear Spoiler	82 84 283	9000 5 door	For the 9000 S model. Kit includes new gas struts to compensate for the additional weight of the spoiler.
• Gas Strut	69 56 288		
• Spoiler	69 92 838		
• Mounting Kit	82 84 267		
Rear Bridge Spoiler	02 45 654	9000 5 door, -92	Requires gas struts
Cover Kit	02 45 670	9000 5 door, -92	Use with 02 45 654



Subject: 900 94- Spoilers

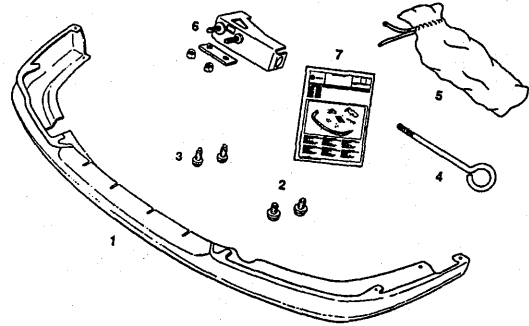
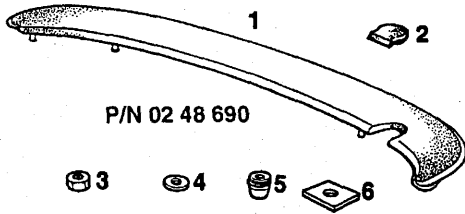
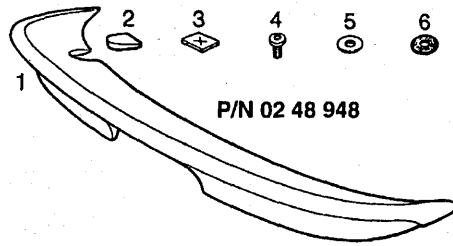

Description	Part Number	Application	Notes
Front Spoiler	02 48 955	94-	
Rear Spoiler	02 48 948	94- 3D, 5D	
Rear Spoiler	46 73 331	94- 3D, 5D	Standard on some 900 Models
Rear Spoiler	02 51 298	95-CV	



Subject: Wind Deflectors

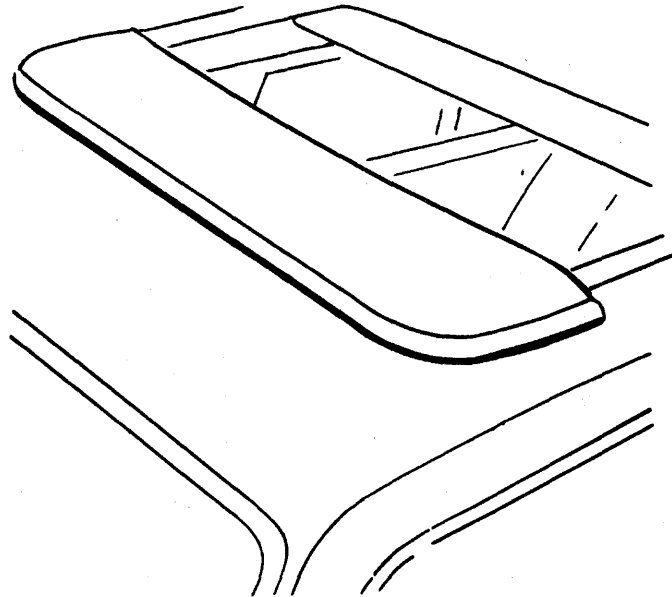

Description	Part Number	Application	Notes
Sunroof Deflector • Mounting Hardware • Rubber Strip	02 72 476 02 71 122 02 71 189	99 900 -93, 94CV	
Sunroof Deflector • Mounting Hardware • Rubber Strip	02 73 581 02 73 607 02 73 599	9000 All	
Sunroof Deflector	02 48 906	900 94-	
Convertible Windscreen	02 51 322	900 CV 95-	Reduces wind buffeting. Also helps contain heat in cabin on cooler days.
Windscreen Mounting Kits: Charcoal Lt. Grey Taupe	02 51 355 02 51 348 02 51 330	900 CV 95- 900 CV 95- 900 CV 95-	



Subject: Side Window Wind Deflectors

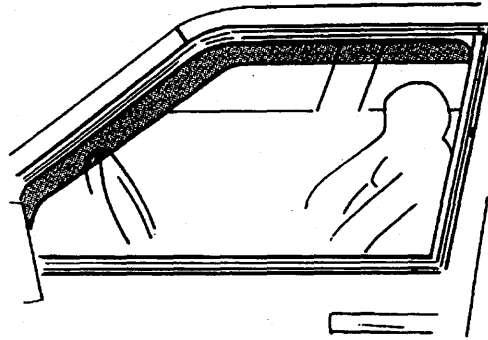

Description	Part Number	Application	Notes
Side Window Deflector	02 60 034	900 81-93	3 door
Side Window Deflector	02 60 042	900 81-93	4 door
Side Window Deflector	02 60 273	900 -80 99 -80	4/5 door



Subject: Moon/Sun Roof

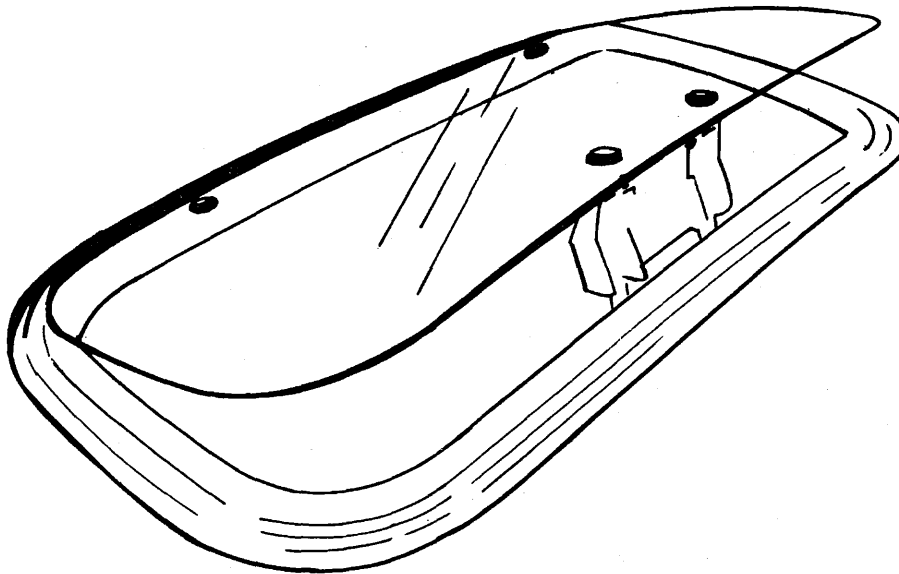

Description	Part Number	Application	Notes
Moonroof • Glass • Handle	02 70 462 02 60 455 02 60 463	99, 900 -93	Discontinued
Electric Sunroof	02 45 621	900 85-93	



Subject: Hood/Door/Trunk Protection

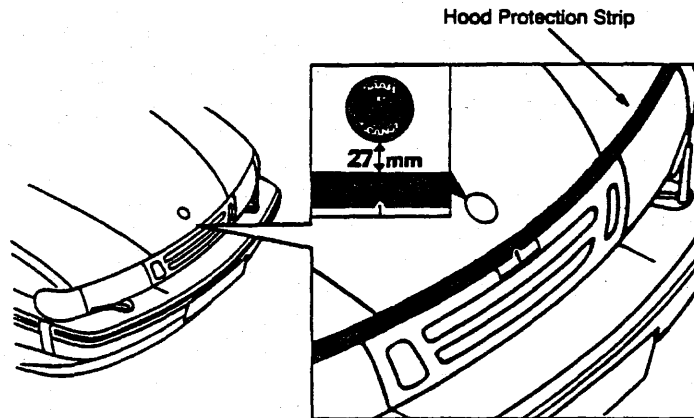

Description	Part Number	Application	Notes
Hood Protection Strips	02 48 294	900 94-	
Hood Protection Strips	02 60 182	900 79-93, 94CV	
Hood Protection Strips	02 71 197	9000 5D-92, 9000 CD -94	
Hood Protection Strips	02 42 370	9000 CS 93- 9000 CD 95-	
Door Edge Guard	02 02 564	All	
Trunk Handle/Black	02 51 819	All	
Trunk Handle/Black Pearl	02 51 827	All	
Trunk Handle/Silver	02 50 357	All	



Subject: Brake Light Kit 900 80-93, 94 CV

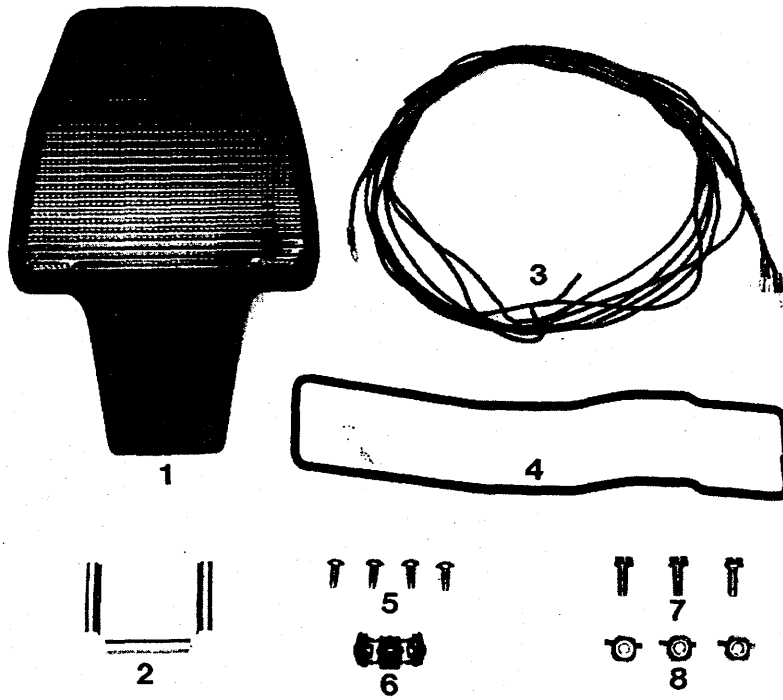

1328 A3

Description	Part Number	Application	Notes
High Mounted Center Brake Light Kit	02 71 239	900 3dr, 80-93	
High Mounted Center Brake Light Kit	02 71 247	900 4dr, 81-93, 94 CV	

Spare Parts on microfiche.



Subject: Touch-Up Paint

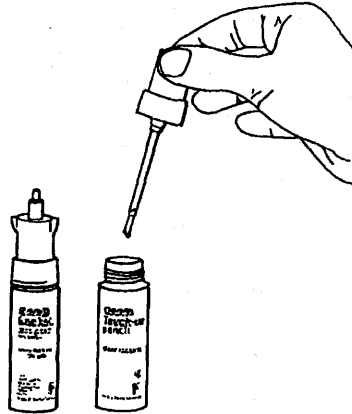

Description	Part Number	Color Code	Notes
Black	02 08 272	BK1/170B	
Nova Black*	N/A	248	
Java Black	02 50 258	253	
White	02 08 025	W1	Discontinued
Orchid White (Coral white)	02 08 140	W2	
Marble White	02 08 355	152G	
Cirrus White	02 08 405	153	
Carrara White	02 45 506	233	
Ivory	02 08 546	155G	
Light Beige	02 08 033	Y5	Discontinued
Beige	02 08 066	Y6	Discontinued
Cameo Beige	02 08 413	161	
Dolomite Sand	02 74 548	162	
Citrin Beige Metallic	02 45 035	227	
Bronze Metallic	02 74 670	201H	
Sepia Metallic	02 08 173	YR5	Discontinued
Sienna Brown	02 08 124	R3	
Dorado Brown	02 08 231	BK2	
Antelope Brown	02 08 249	YR6	Discontinued
Chammotte Brown	02 08 330	167H	
Walnut Brown	02 08 462	169G	
Ambra Yellow	02 08 074	Y8	
Brilliant Yellow	02 08 108	Y9	Discontinued
Sunset Orange	02 08 132	Y11	
Topaz Yellow	02 08 215	Y12	
Alabaster Yellow	02 08 322	187B	
Monte Carlo Yellow	02 45 456	231	

* Available only on 1994 Commemorative Edition Convertible. Not available as touch-up paint stick. Must be special ordered from Sweden as a spray paint only. Contact Parts Ordering Desk in Norcross for information.

(continued next page)

**SAAB**

ACCESSORIES

Description	Part Number	Color Code	Notes
Cayenne Red Metallic	02 50 316	256	
Torreador Red	02 08 017	R2	
Cinnibar Red (Solar Red)	02 08 165	R4	Discontinued
Copper Coral Metallic	02 08 181	YR4	
Cardinal Red Metallic	02 08 264	R6	Discontinued
Carmine Red	02 08 389	124B	Discontinued
Terracotta Red	02 08 421	126G	
Cherry Red	02 08 538	127H	
Cherry Red II	02 76 451	214H	
Ruby Red Metallic	02 08 470	125H	Discontinued
Amaranth Red	02 08 579	113G	
Carmosine Red Metallic	02 74 555	120G/206G	Discontinued
Maroon	02 08 512	168B	
Sandstone Metallic	02 76 469	212B	Discontinued
Garnet Red	02 43 758	213B	
Talladega Red	02 44 418	219	
Ruby Red (Mica)	02 46 645	242	
Imola Red	02 46 637	240	Discontinued
Aubergine	02 48 385	241	
Silver Crystal Metallic	02 08 199	SK1	
Anthracite Grey Metallic	02 08 526	SK2	Discontinued
Sterling Silver Metallic	02 08 298	SK3	
Anthracite Grey-Bumper Color	02 81 584	176	
Silver Metallic	02 08 454	172H/200H	
Rose Quartz Metallic	02 08 587	129H/202H	
Edwardian Grey Metallic	02 74 522	158/204B/223	
Arctic Silver	02 44 426	220	
Platana Grey Metallic	02 45 043	228	
Silver Metallic	02 49 540	247	
Midnight Blue Metallic	02 50 324	257	
Amethyst Violet Metallic	02 50 332	258	
Middle Blue	02 08 058	B7	Discontinued
Carolina Blue	02 08 090	B8	
Astral Blue	02 08 280	B9	
Azure Blue	02 08 306	B10	Discontinued
Midnight Blue	02 08 348	136H	Discontinued
Aquamarine Blue	02 08 363	137H	
Indigo Blue Metallic	02 08 447	139H	
Admiral Blue	02 08 504	131H	
Zircon Blue	02 74 514	157	Discontinued
Embassy Blue	02 74 662	198G	
Azure Blue	02 08 553	116B	
Indigo Blue Metallic	02 08 496	130G	
Slate Blue Metallic	02 08 520	112B	
Platinum Blue Metallic	02 08 561	117H/203H	
Nocturne Blue Metallic	02 45 498	234	
LeMans Blue Metallic	02 45 050	229	
Sky Blue Metallic	02 49 946	252	
Verona Green	02 08 082	GN8	Discontinued
Verona Green	02 08 116	GN9	Discontinued
Emerald Green	02 08 157	GN10	Discontinued
Opal Green (Spring Green)	02 08 207	GN11	Discontinued
Jade Green	02 08 314	GN12	Discontinued
Pine Green Metallic	02 08 488	140B	Discontinued
Acacia Green	02 08 371	148B	Discontinued
Pine Green Metallic	02 08 439	149B	Discontinued
Malachite Metallic	02 74 530	159G/205G	
Beryl Metallic	02 44 442	216G/226	
Eucalyptus Green Metallic	02 45 480	235	
Scarabe Green	02 45 191	230	



Subject: Skid Plate

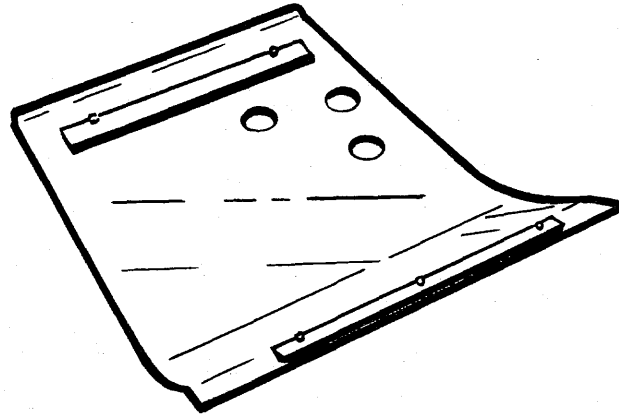

Description	Part Number	Application	Notes
Engine Skid Plate <ul style="list-style-type: none">• Front Mounting Bolt• Rear Mounting Bolt	00 24 919 79 70 015 81 48 223	900 79-93, 94CV	Covers complete Under Engine Area 8 x 30 mm 10 x 30 mm

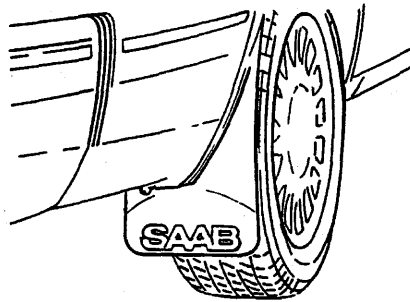
**Subject: Mudflaps 900/99**

Description	Part Number	Application	Notes
Rear Mudflaps Kit	69 39 375	900 87-93 3CK	Contains flaps plus mounting hardware.
• Mudflap, LH	69 37 593		
• Mudflap, RH	69 37 585		
Rear Mudflaps Kit	69 39 383	900 87-93 4SN	Contains flaps plus mounting hardware.
• Mudflap, LH	69 37 478		
• Mudflap, RH	69 37 486		
Rear Mudflaps Kit	78 74 340	900 -86	Contains flaps plus mounting hardware. 16 ¹ / ₂ "
• Mudflap, LH	78 73 995	900 -86, 99	Mounting screws included. 16 ¹ / ₂ "
• Mudflap, RH	78 74 001	900 -86, 99	Mounting screws included. 16 ¹ / ₂ "
Rear Mudflap, LH	78 73 565	900 81-86	Mounting screws included. 17 ¹ / ₂ "
Rear Mudflap, RH	78 73 573	900 81-86	Mounting screws included. 17 ¹ / ₂ "
Rear Mudflap Kit	96 98 408	1988- SPG	
• Flap LH	96 98 382		
• Flap RH	96 98 390		
Rear Mudflap Kit	02 48 922	94-, 95- CV 900	



Subject: 9000 Mudflaps 86-

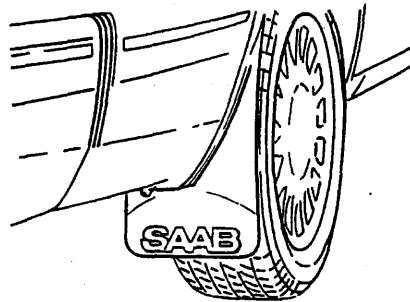

Description	Part Number	Application	Notes
Rear Mudflap Kit (Mid-length)	02 43 451	86-91	
• LR Mudflap (RR N/A)	02 43 824		
• Screw	79 73 175		
• Nut	79 75 261		
Front Mudflap Kit (Mid-length)	02 45 423	86-92 5D, CD -94	
• LH Mudflap	02 43 808		
• RH Mudflap	02 43 816		
• Nut	92 88 846		
• Screw	79 76 988		
• Screw	80 59 271		
Front Mudflap Kit (Full length)	82 84 721	93-5D	(Except Aero)
• LH Mudflap w/ Hardware	82 84 747		
• RH Mudflap w/ Hardware	82 84 739		
Rear Mudflap Kit (Full length)	78 74 431	86-91	
• LH Mudflap	92 68 038		
• RH Mudflap	92 68 020		
• Screw	79 73 134		
• Nut	79 75 261		
Rear Mudflap Kit (Short)	02 45 514	9000 5D 93-	
Rear Mudflap Kit (Long)	82 84 341	9000 5D, 93-	(Except Aero)



Subject: Roof-Mounted Rack Systems

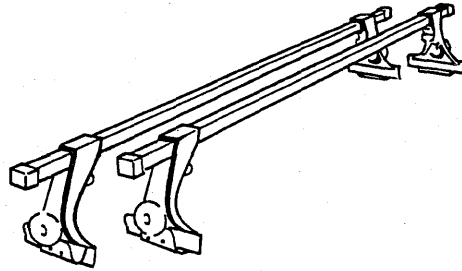

Description	Part Number	Application	Notes
Basic Crossbar Rack Thule 1050 System	02 81 709	900 Sedan, 99 -93	Mounts on rain gutters. Replaces 02 81 121.
• Cross Bar End Plug	02 72 369		
• Rack Foot Rubber Pad	02 72 377		
• Small Knob	02 72 385		
Rack Bars	02 48 286	900 Sedan 5D 94--	Mounts in factory predrilled mountings in the door jamb. Automatically locks carrier to car when doors are shut.
Rack Bars	02 48 716	900 Sedan 3D 94--	
Rack Bars	02 48 369	9000 All	
ADAPTERS			
Bike Holder	02 81 683	900 All Sedans, 9000 All	1 Bike upside down. (Discontinued)
Bike Holder Locks	02 81 196	900 All Sedans, 9000 All	Use with 02 81 683 (Discontinued)
Bike Holder	02 50 480	900 All Sedans, 9000 All	1 Bike upright.
Bike Holder Locks	02 50 548	900 All Sedans, 9000 All	Use with 02 50 480 Contains two lock cylinders Locks bike in holder and holder to roof rack.
Bulk Luggage Carrier	02 81 204	900 All Sedans, 9000 All	4 per set
Load Stops	02 81 246	900 All Sedans, 9000 All	
• M6 Knob	02 44 285	900 All Sedans, 9000 All	
Lock Knobs	02 81 162	900 Sedan-93	4 per set. 1050 only. Locks carrier to roof.
Quick Strap	02 44 467	900 All Sedans, 9000 All	Terylene strap on ratchet type mechanism for tightening.
Luggage Straps	02 44 376	900 All Sedans, 9000 All	2 straps 1" x 140"
Ski Rack	02 81 303	900 All Sedans, 9000 All	Lockable for two pairs of skis.
Windsurfer Rack	02 45 233	900 All Sedans, 9000 All	Lockable for 6 pairs of skis.
Snowboard/Ski Rack	02 45 977	900 All Sedans, 9000 All	
Canoe Carrier	02 51 397	900 All Sedans, 9000 All	Holds 1.
Kayak Carrier, Ocean	02 51 413	900 All Sedans, 9000 All	Holds 1.
Kayak Carrier, White-Water	02 51 405	900 All Sedans, 9000 All	Holds 2.



Subject: 9000 Rack Spare Parts

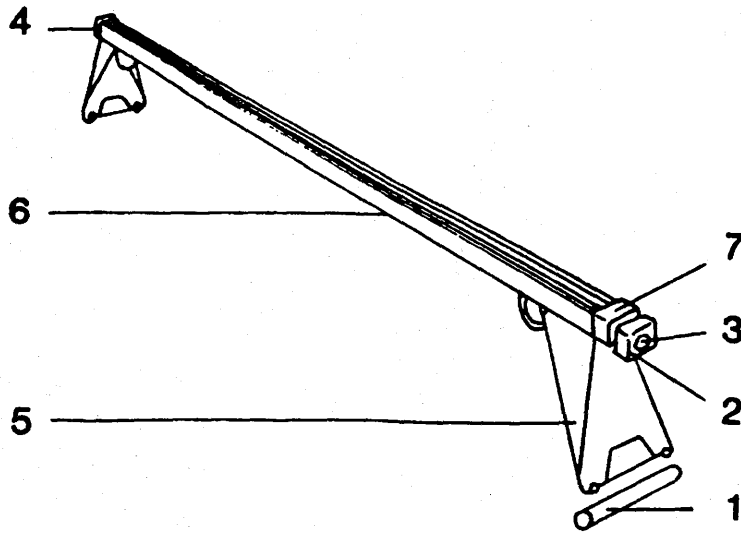

Description	Part Number	Application	Notes
Plastic Sleeve	02 73 805		
End Cap	02 73 813		
Bolt	02 73 821		
End Cap	02 73 839		
Foot	02 73 847		
End Cap	02 73 862		



Subject: Trunk Mounted Racks

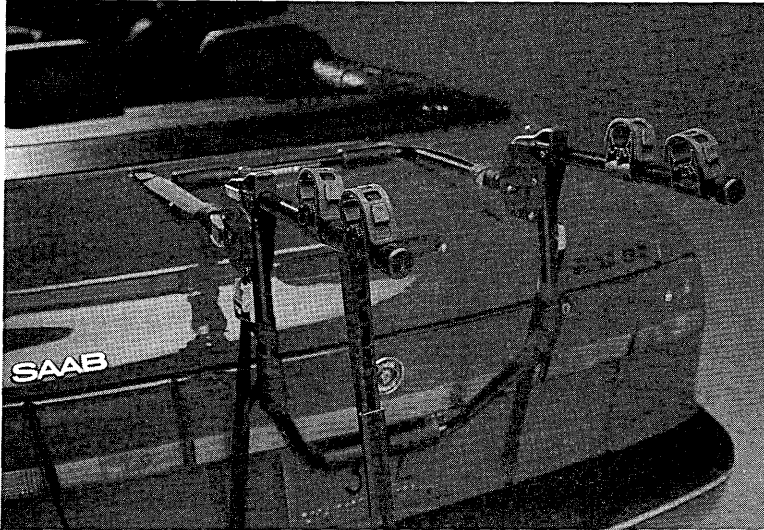

Description	Part Number	Application	Notes
Ski Rack	02 43 857	-94 CV	
Bike Carrier	02 50 498	CV 95-	Non-Lockable



Subject: Towing Accessories, 900

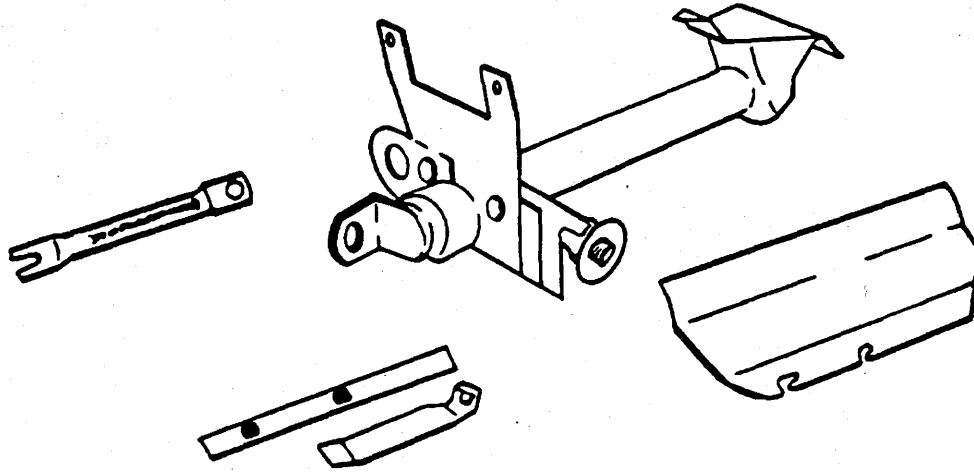

Description	Part Number	Application	Notes
Fixed trailer hitch	02 30 391		-93, 94CV
• "SAAB" End Plug	02 30 300		
Removeable trailer hitch kit	02 71 254		-93, 94CV
• Draw Bar	02 44 319		
• Plastic cover	02 73 987		
• Pry-bar tool	02 75 073		
Wiring harness	02 30 102		
• Connector plug	02 30 540		
Trailer connector plug	02 30 110		
Trailer Hitch Kit (Includes wiring harness and ball)	02 48 823		900 94-
• Spare part wiring harness	02 49 656		
• Junction Box	02 50 233		



Subject: Towing Accessories, 9000

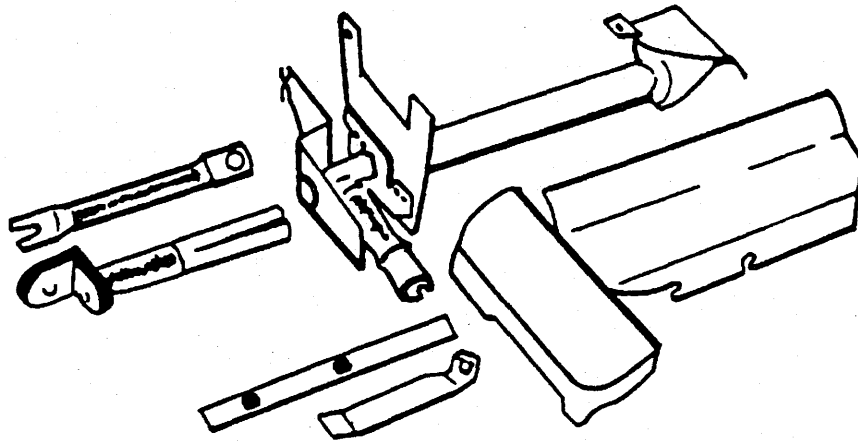

Description	Part Number	Application	Notes
Trailer hitch kit	02 72 054		5DR, -92
• Plastic cover	02 73 995		
• Tool	02 75 073		
Trailer hitch kit	02 49 557		4DR (CD) -94
• Plastic cover/cap	02 43 741		
• Tongue/ball mount	02 44 293		
• Tool	02 75 073		
Wiring harness kit	02 42 438		5DR -92, 4D (CD) -94
• Connector plug	02 30 540		
Trailer connector plug	02 30 110		
Trailer hitch kit (includes wiring and ball)	02 48 831		9000 CS 93-, 9000 CD 95
• Junction Box	02 50 233		
• Wire harness	02 50 241		



Subject: 900 Airflow Components – 1986

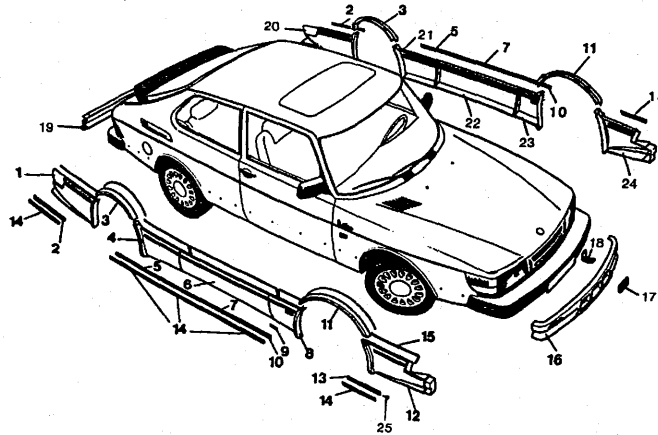

Description	Part Number	Application	Notes
Airflow Kit	00 26 989	900 -86 3CK, 2SN	
1. Sideshield – Rear RH	02 74 258		
2. Siderail – Rear RH, LH	02 74 266		
3. Wheel Housing Moulding Rear RH, LH	02 74 274		
4. Sideshield – Door RH	02 74 282		
5. Siderail – Valance, RH, LH	02 74 290		
6. Sideshield – Door RH	02 74 308		
7. Siderail – Door RH, LH	02 74 316		
8. Sideshield – Front fender RH	02 74 324		
10. Siderail – Front fender RH, LH	02 74 340		
11. Wheel Housing Moulding Front RH, LH	02 74 357		
12. Sideshield – Front RH	02 74 365		
13. Siderail – Front RH, LH	02 74 373		
14. Siderail Decor Insert – Roll	02 74 381		Enough length for one kit
15. Side Panel Moulding – Roll	02 74 399		Enough length for one kit
16. Front Spoiler	02 74 407		
17. Fog Light Aperture Cover	02 74 415		
18. Front Spoiler Fastening Bracket	02 74 423		
19. Rear Spoiler	02 74 431		
20. Sideshield – Rear LH	02 74 449		
21. Sideshield – Valance LH	02 74 456		
22. Sideshield – Door LH	02 74 464		
23. Sideshield – Front fender LH	02 74 472		
24. Sideshield – Front LH	02 74 480		
25. Side Moulding Caps	02 74 498		Full Set
• Tow Hook	02 74 506		Not pictured
• Zinc Foil Washer 3mm	92 30 293		Not pictured
• Rubber Expanding Nuts	82 51 753		Not pictured
• Rubber Plug	70 35 801		Not pictured – Mount in front of rear wheels.

** Discontinued



Subject: Airflow Components, 900 3CK 1987 -93, 94 CV

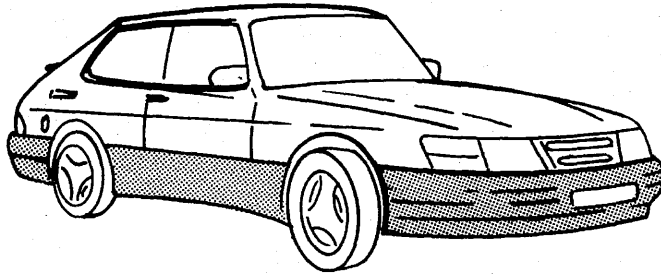

Description	Part Number	Application	Notes
Front and rear spoiler set • Bottom skirt • Front spoiler • Towing eye • Rear spoiler	02 74 910 02 43 071 02 77 525 02 77 541 02 77 566		with hardware with hardware
Side skirt set	02 74 928		Same as SPG See group 8 for SPG spares
Wheel arch flare kit • Front flare • Front flare • Rear flare • Rear flare	02 45 365 02 45 415 02 45 407 02 45 399 02 45 381		LH RH LH RH
Wheel arch flare kit • Front flare • Front flare • Rear flare • Rear flare	02 74 936 02 77 590 02 77 608 02 77 616 02 77 624		Supercedes to 02 45 365 LH RH LH RH
Fog light openings covers (pair)	02 45 449		



Subject: 9000 Airflow, 86-90 5D

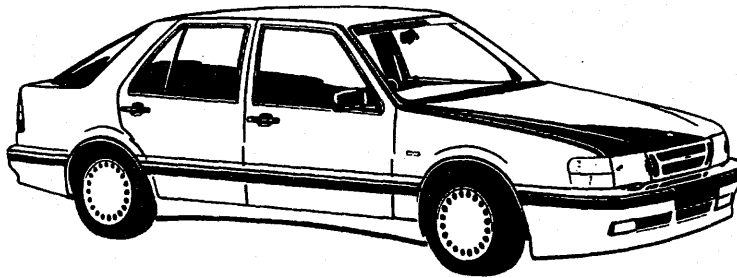

Description	Part Number	Application	Notes
Airflow Kit	02 44 152	9000 86-90 5 dr (Discontinued)	Generation II complete kit including bumper covers, side skirts, fender flares and air dam.
<ul style="list-style-type: none"> • Front Bumper • Rear Bumper • Left Front Fender Flare • Right Front Fender Flare • Left Rear Fender Flare • Right Rear Fender Flare • Left Bottom Skirt • Right Bottom Skirt • Cover Kit • Air Dam 	<ul style="list-style-type: none"> 02 44 160 02 44 178 02 44 202 02 44 210 02 44 228 02 44 236 02 44 186 02 44 194 02 44 244 02 44 251 		With mounting hardware With mounting hardware Each fender flare includes appropriate mounting hardware With mounting hardware With mounting hardware Covers for fog light openings in front spoiler With mounting hardware
Airflow Kit	02 74 951	9000 86-90 5 dr (Discontinued)	Generation I complete kit including front spoiler, side skirts, fender flares and rear spoiler.
<ul style="list-style-type: none"> • Front Spoiler • Rear Spoiler • Left Front Fender Flare • Right Front Fender Flare • Left Rear Fender Flare • Right Rear Fender Flare • Left Rocker Panel • Right Rocker Panel • Left Front Door Skirt • Right Front Door Skirt • Left Rear Door Skirt • Right Rear Door Skirt 	<ul style="list-style-type: none"> 02 44 160 02 44 178 02 77 707 02 77 715 02 77 723 02 77 731 02 77 756 02 77 764 02 77 780 02 77 798 02 77 806 02 77 814 		With mounting hardware With mounting hardware Each rocker panel includes appropriate mounting hardware Each door skirt includes appropriate mounting hardware.

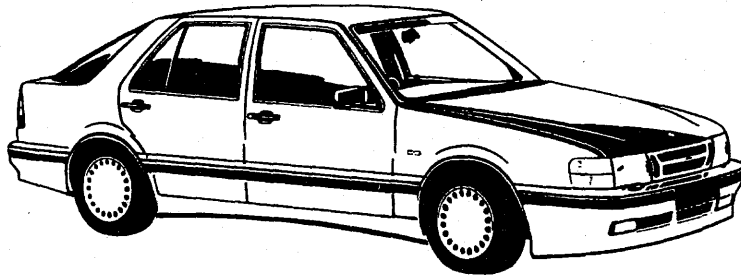
**Subject: Airflow Kit 9000 4 door, 89-94 9000 CD**

Description	Part Number	Application	Notes
Airflow Kit	02 44 798		Complete kit. Primed for painting. (Discontinued)
Bumper Strip Kit	02 44 848		Front and rear bumper insert strips to match the chrome strips in the lower body side moulding.
Spare Parts for Airflow Kit			
• Front Bumper	02 44 855		With mounting hardware
• Rear Bumper	02 44 863		With mounting hardware
• Left Bottom Skirt	02 44 871		With mounting hardware
• Right Bottom Skirt	02 44 889		With mounting hardware
• Left Front Fender Flare	02 44 897		Each fender flare includes appropriate mounting hardware
• Right Front Fender Flare	02 44 905		
• Left Rear Fender Flare	02 44 913		
• Right Rear Fender Flare	02 44 921		
• Front Spoiler Grill	02 44 939		
• Pop Rivet Kit	02 44 954		



Subject: Fender Flares, 9000 -1990

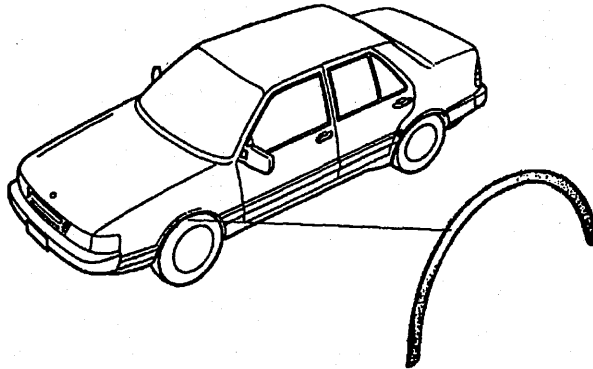

Description	Part Number	Application	Notes
Fender Flare Kit	02 44 525		-1990, Not for Air Flow Equipped Cars
Fender Flare	02 44 533		LH, Includes hardware
Fender Flare	02 44 541		RH, Includes hardware
Fender Flare	02 44 558		LH, Includes hardware
Fender Flare	02 44 566		RH, Includes hardware



Subject: Rear Decor Panels, 900, 9000

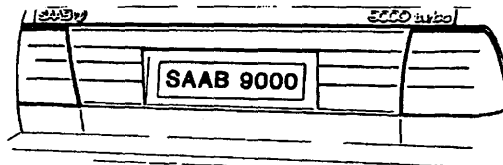
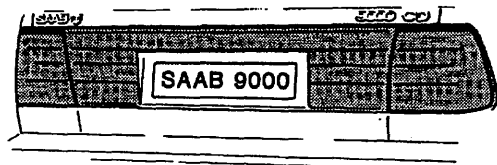

Description	Part Number	Application	Notes
Rear Decor Panel	02 48 930	900 94-	Matches taillights.
Rear Decor Panel	02 43 006	9000 5 DR -92	Three color panel, mounts between rear tail lights and continues the color pattern of lenses across the back of the car. (Discontinued)
Rear Decor Panel	02 45 118	9000 CD 91-94	
Rear Decor Panel	02 43 329	9000 CD -89	Continues tail light pattern across trunk lid between lights.
Rear Decor Panel	02 44 509	9000 CD 1990	Continues tail light pattern across trunk lid between lights.
Rear Decor Panel	02 71 163	9000 5 DR	Black panel, mounts behind license plate. (Discontinued)



Subject: Vanity Plates and Plate Frames

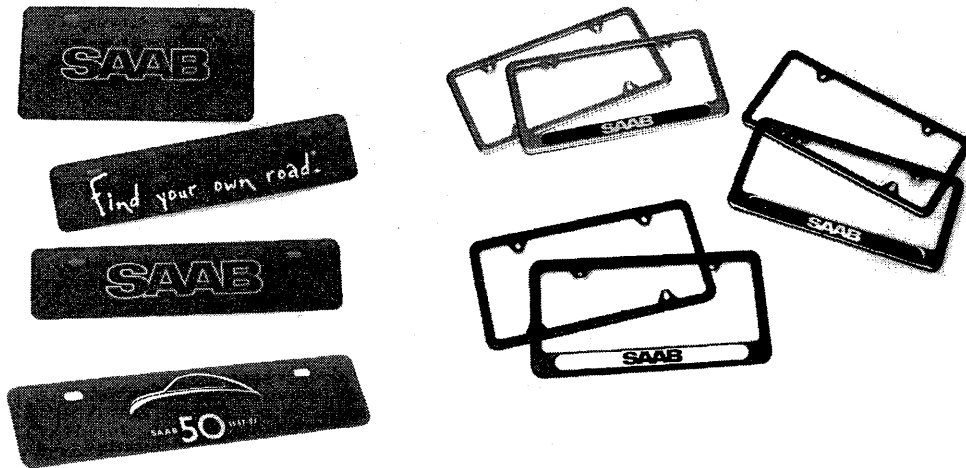

Description	Part Number	Application	Notes
Plate Frame/Black	02 50 399		All plate frames and vanity plates come with color-keyed screw caps.
Plate Frame/Black Pearl	02 51 777		
Plate Frame/Silver	02 50 415		
SAAB Logo Plate Frame/Black	02 50 381		
SAAB Logo Plate Frame/Black Pearl	02 51 785		
SAAB Logo Plate Frame/Silver	02 50 407		
Vanity Plate/SAAB Logo/US Style	02 50 449		
Vanity Plate/SAAB Logo/Euro Style	02 50 423		
"FYOR" Plate/Euro Style	02 50 431		
50 th Anniversary Plate/Euro Style	02 51 801		
Extra Screw Caps/Black	02 50 373		
Extra Screw Caps/Black Pearl	02 51 793		Spare part. Pack of 2.
Extra Screw Caps/Silver	02 50 365		Spare part. Pack of 2.

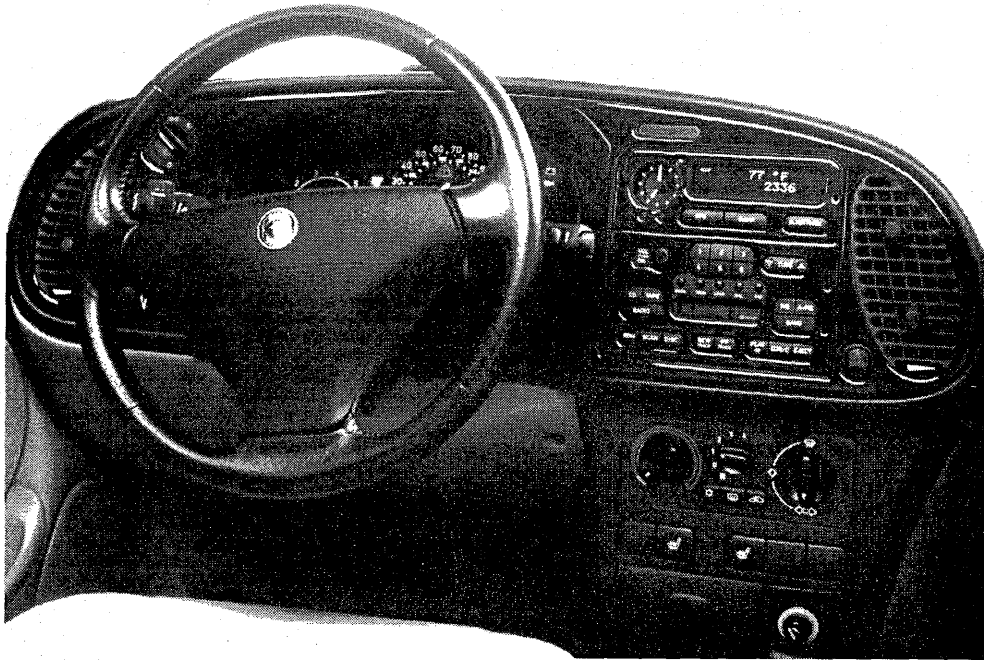
**Subject: Interior Accents**

Description	Part Number	Application	Notes
Burled Walnut Dash Kit	02 51 447	900 3D/5D 94-, CV 95-	Full dash covering, including radio and SID surrounds.
Burled Walnut Radio Surround	02 52 825	900 3D/5D 94-, CV 95-	Spare part.
Burled Walnut SID Surround	02 52 817	900 3D/5D 94-, CV 95-	Spare part.
Burled Walnut Door Pulls	02 51 454	900 3D/5D 94-, CV 95-	Pair.
Carbon Fiber Dash Kit	02 51 421	900 3D/5D 94-, CV 95-	Full dash covering, including radio and SID surrounds.
Carbon Fiber Radio Surround	02 52 809	900 3D/5D 94-, CV 95-	Spare part.
Carbon Fiber SID Surround	02 52 791	900 3D/5D 94-, CV 95-	Spare part.
Carbon Fiber Door Pulls	02 51 439	900 3D/5D 94-, CV 95-	Pair.
Adhesive Promoter Pen	02 52 833	900 3D/5D 94-, CV 95-	Spare part. One pen packaged in each Dash Kit.

(continued next page)

**SAAB**

ACCESSORIES

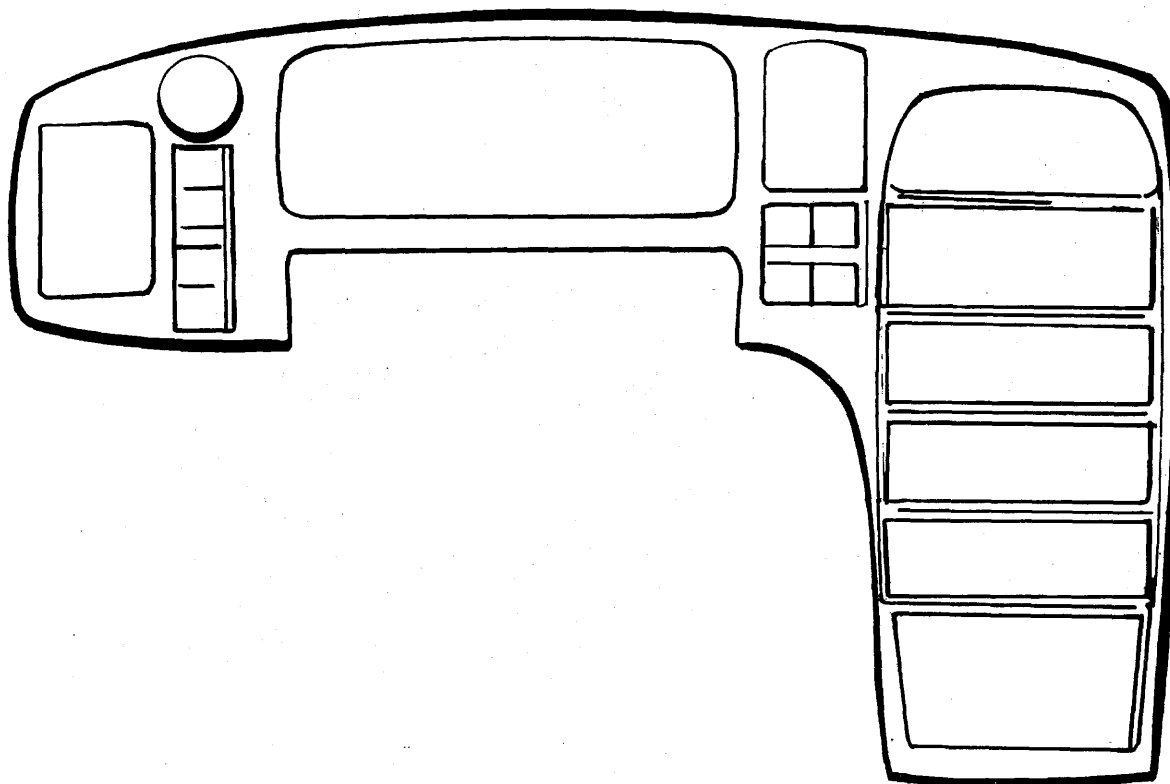
Subject: Interior Accents

Description	Part Number	Application	Notes
Wood Dashboards	02 48 914 02 45 738 02 44 475 02 45 571	900 94- 900 -93, CV -94 9000 86-91 9000 92-	OE replacement. OE replacement. OE replacement. OE replacement.
Trimplate - Manual gear selector	02 44 483	9000 86-	OE replacement.
Trimplate - Automatic gear selector	02 44 491	9000 86-	OE replacement.
Center Console Cover	02 45 175 44 36 226	9000 -93 9000 94-	OE replacement. OE replacement.
Wood Door Cap and Glove Box Kit	02 48 971 02 48 989	900 5D 94- 900 3D, CV 95-	Includes glove box trim. OE Style. Includes glove box trim. OE Style.
Wood Glove Box Trim	02 48 997	900 94-	OE Style.

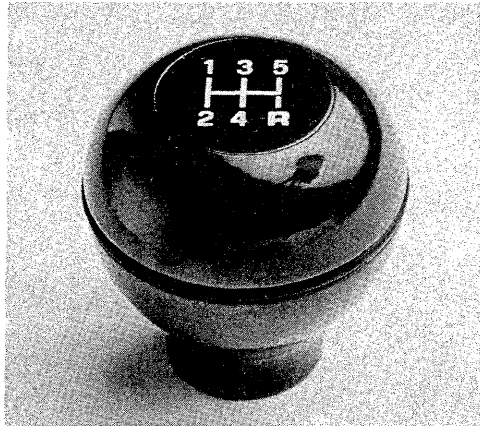
**Subject: Gearshift Accessories**

Description	Part Number	Application	Notes
Wood Shift Knob			
• Walnut	02 48 872	900 94-, 9000 from VIN N1004567	
• Griffin Mark Mahogany	02 76 378	9000 up to VIN N1004566	
• 5-speed Mahogany	00 26 781	900 79-93, 94CV	
Leather Shift Knob	02 48 880	900 94-, 9000 from VIN N1004567	
Leather Shift Knob	02 43 188	9000 up to VIN N1004566	
Leather Shift Knob	02 43 139	900 79-93, 94CV	
Boot Cover	02 43 196	9000 up to VIN N1004566	
Boot Cover	93 98 215	900 83-93, 94CV	
Boot Cover	02 48 898	900 94-	
Boot and Knob Kit	02 45 985	9000 from VIN N1004567	



**Subject: 900 Center Console -93, 94 CV
(See microfiche for O.E. Console spare parts)**

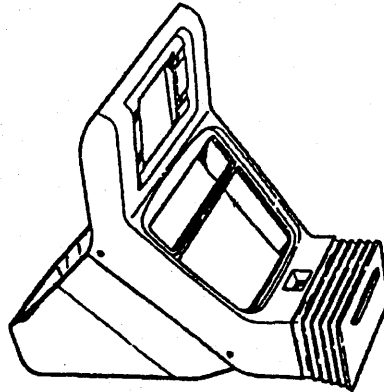

Description	Part Number	Application	Notes
Center Console Set	02 58 269	900 83-	Black face with hardware. See S.I. 02/87-931 when installing on a 1983-85 900 Turbo EAG. Color keyed console bottom section required. (Discontinued)
Persian Blue Console Bottom	02 61 545	900 84-87	
Colorado Red Console Bottom	98 14 146	900 84-85	For Colorado leather interior cars
Bokhara Red Console Bottom	02 57 956	900 83-	Also for Colorado leather interior cars 1986-
Sierra Tan Console Bottom	02 58 293	900 83-84	
Sierra Tan Console Bottom	98 48 029	900 85-88	Also for Sierra leather interior cars 1986-88
Tan Console Bottom	02 43 246	900 89-	
Sierra Console Bottom	98 14 138	900 84-85	For Sierra leather interior cars
Cashmere Console Bottom	02 70 421	900 86	
Labrador Console Bottom	02 70 413	900 86-	
Marine Blue Console Bottom	96 82 394	900 86-	

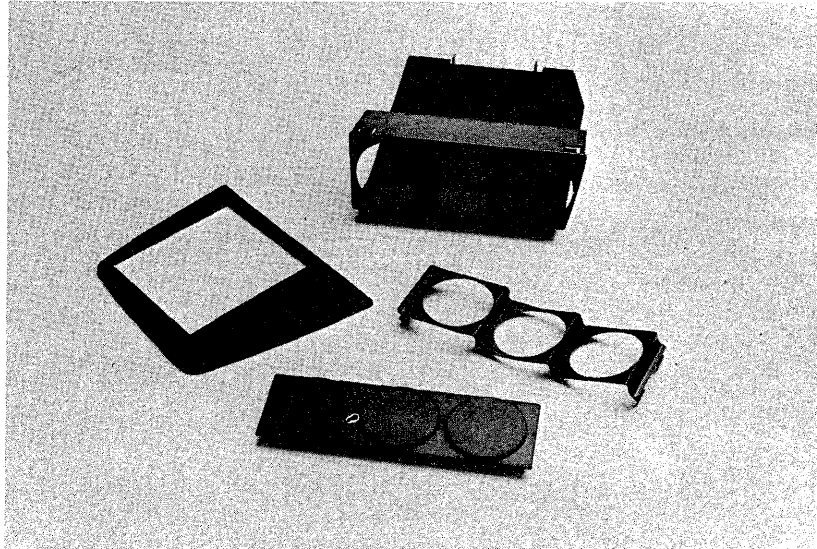
**Subject: Console Adapters/Faceplates 900**

Description	Part Number	Application	Notes
Gauge Adapter	02 73 235	900 83-93, 94CV	Used with 02 58 269 or any DIN opening. Snaps into place. Plastic with 3 holes for gauges.
• Cover	02 71 213		Cover for instrument apertures in gauge adapter.
Gauge Adapter	02 71 205	900 83-93, 94CV	Plastic, 3 gauge holder. Use with center console 02 58 269 and fits directly below the equalizer. Permits turbo owners (with E.Q.'s) to use gauges.
Cassette Holder and Adapter	02 57 881	900 83-93, 94CV	Mounts into lower section of center console. Includes cassette holders.
Blank Upper Plate	02 57 964	900 83-93, 94CV	Mounts in upper section of center console.

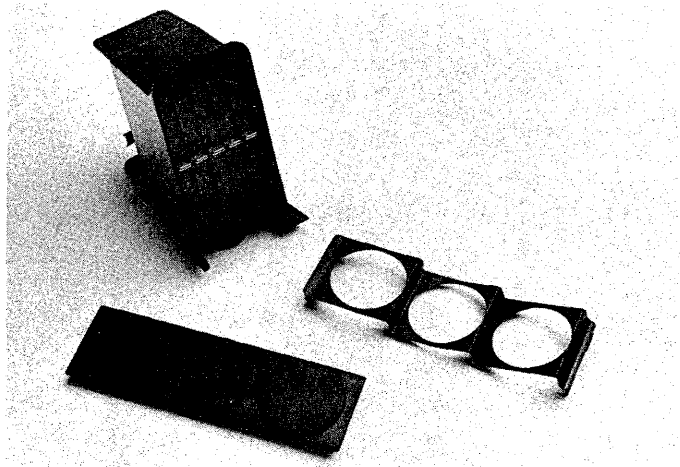
**Subject: Console Adapters 9000**

Description	Part Number	Application	Notes
Gauge Adapter	02 73 235	9000	Plastic adapter for 3 gauges. Snaps into DIN size opening.
• Cover	02 71 213		Covers for instrument aperture in gauge adapter.
Cassette Holder	02 76 287	9000	Mounts in center console.
Blank Lower Plate	02 70 439	9000	Mounts in lower section of center console. Back of plate is marked with checker pattern for easy cutting of gauge holes.
Two Gauge Adapter	02 74 720	9000	Plastic. To be installed in bottom console opening.



Subject: Carpet Floor Mats, 900

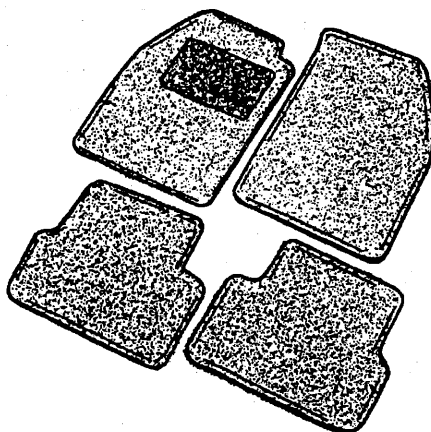

Description	Part Number	Application	Notes
Tan	02 46 843	-93 900, -94CV	Set of 4.
Blue	02 46 835	-93 900, -94CV	Set of 4.
Grey	02 46 827	-93 900, -94CV	Set of 4.
Taupe	02 46 850	-93 900, -94CV	Set of 4.
Charcoal	02 48 252	94- 900 3D/5D	Set of 4.
Light Grey	02 48 260	94- 900 3D/5D	Set of 4.
Taupe	02 48 245	94- 900 3D/5D	Set of 4.
Charcoal	02 49 516	95- 900CV	Set of 4.
Light Grey	02 49 524	95- 900CV	Set of 4.
Taupe	02 49 508	95- 900CV	Set of 4.
Mat Strap and Clip	02 70 686		1 pair of straps and clips
Auger Clips	02 46 868		1 pair
Mat Brackets	02 48 799	94- 900	Single
REPLACEMENT DRIVERS MATS			
Red	02 43 576	-93 900, -94CV	
Tan	02 43 626	89-93, 94CV 900	
Grey	02 43 584	-93 900, -94CV	
Blue	02 43 618	-93 900, -94CV	
Taupe	02 45 803	-93 900, -94CV	



Subject: Carpet Floor Mats, 9000

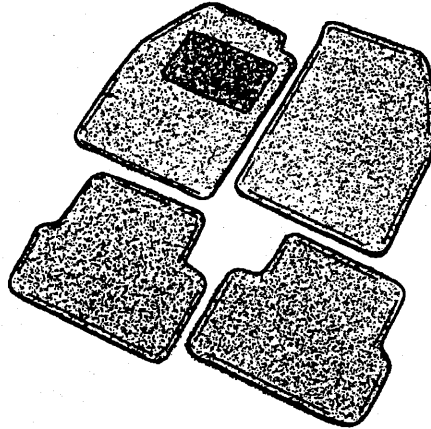

Description	Part Number	Application	Notes
Red	02 70 322	86-	Set of 4.
Tan	02 46 801	86-	Set of 4.
Blue	02 46 793	93	Set of 4.
Grey	02 46 785	86-	Set of 4.
Taupe	02 46 819	93-	Set of 4.
Mat Strap and Clips	02 70 686		1 pair of straps and clips
Auger Clips	02 46 868		1 pair
REPLACEMENT DRIVERS MATS			
Tan	02 43 683	All	
Grey	02 43 642	90-	
Blue	02 43 675	All	
Taupe	02 45 795	All	



Subject: All-Season Floor Mats

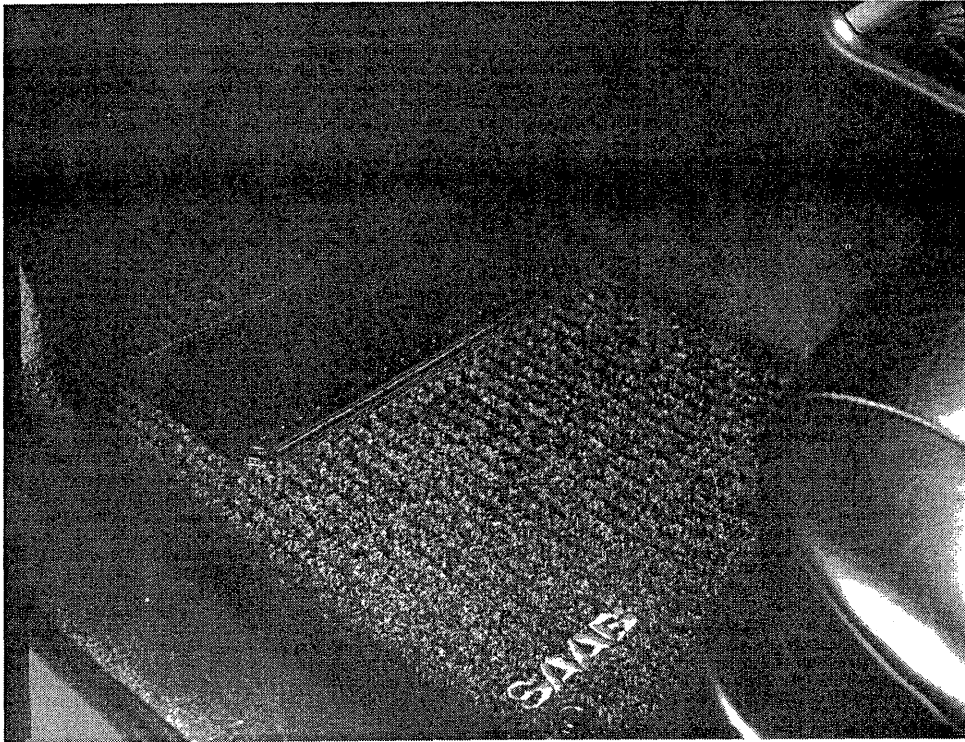

Description	Part Number	Application	Notes
All-Season Mats	02 51 363	900 3D/5D 94-	Deep Charcoal Grey. Set of 4
All-Season Mats	02 51 371	900 CV 95-	Deep Charcoal Grey. Set of 4.

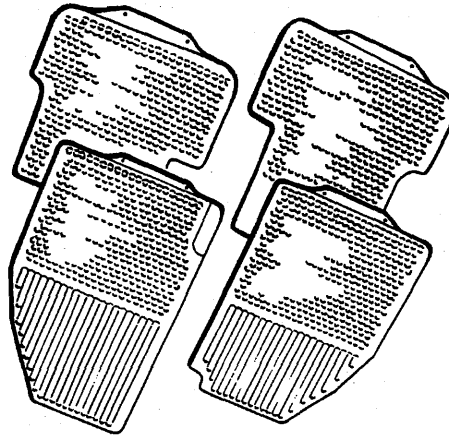
**Subject: Rubber Floor Mats, 900**

Description	Part Number	Application	Notes
Grey	02 45 290	-93, 94 CV	Set of 4.
Blue	02 45 308	-93, 94 CV	Set of 4.
Taupe	02 45 589	92-93, 94 CV	Set of 4.
Red Thermoplastic Mat Set	02 45 789	-93	Set of 4.
Grey	02 45 674	94- 3D, 5D	Set of 4.



Subject: Rubber and Thermoplastic Floor Mats, 9000

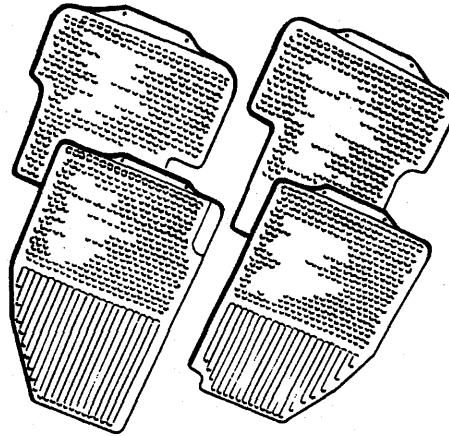

Description	Part Number	Application	Notes
Grey	02 45 316	All	Set of 4.
Blue	02 45 225	All	Set of 4.
Red	02 45 217	All	Set of 4.
• Mounting Kit	02 44 707	All	To fasten driver's mat to floor
Red Thermoplastic Mat Set	02 45 357	All	Front Pair
Blue Thermoplastic Mat Set	02 45 373	All	Front Pair



Subject: 9000 Center Armrests

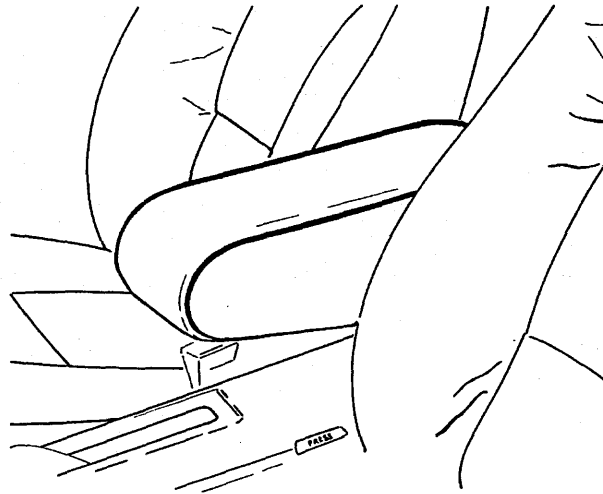

Description	Part Number	Application	Notes
COMPLETE ARMREST			
Red leather	02 44 095		
Blue leather	02 44 129		
Grey wool	02 46 660		
ARMREST COVER			Needs Armrest Core
Tan leather	02 48 518		
Grey leather	02 48 500		
Light Grey leather	02 48 534		
Taupe leather	02 48 542		
Black leather	02 48 559		
Sand beige leather	02 49 722		
ARMREST CORE	02 48 492		
• Bolt	79 65 544		
• Cage nut	79 75 006		
• LH End cover	02 45 969		
• RH End cover	02 45 951		



Subject: Child Seats

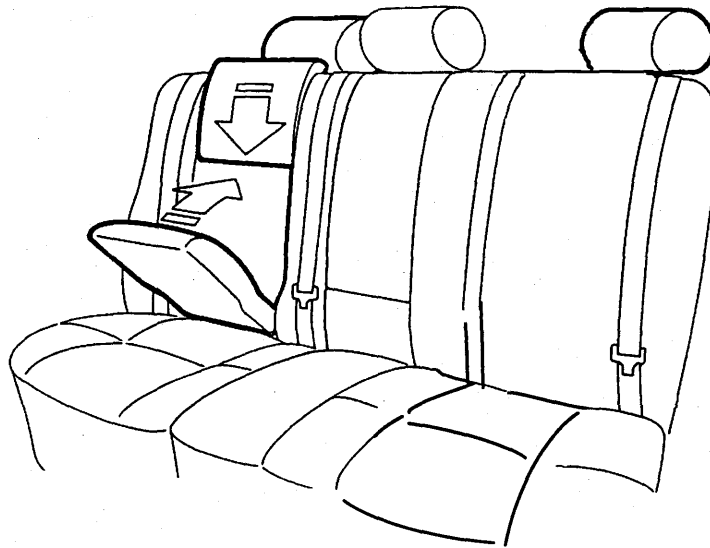

Description	Part Number	Application	Notes
INTEGRATED CHILD SEAT		900 94- from VIN R2027183- 3D, 5D (not CV)	
Velour	02 49 730	RH	
Leather	02 49 748	RH	
Add Info Part <ul style="list-style-type: none"> • State VIN # • State Interior Color Code 			Fax order to Main Office
Child Booster Chair	02 50 522	900 All, 9000 All	
Child Booster Seat	02 52 841	900 All, 9000 All	
Child Booster Seatback	02 52 858	900 All, 9000 All	Optional. For use with 02 52 841.



Subject: Car Covers

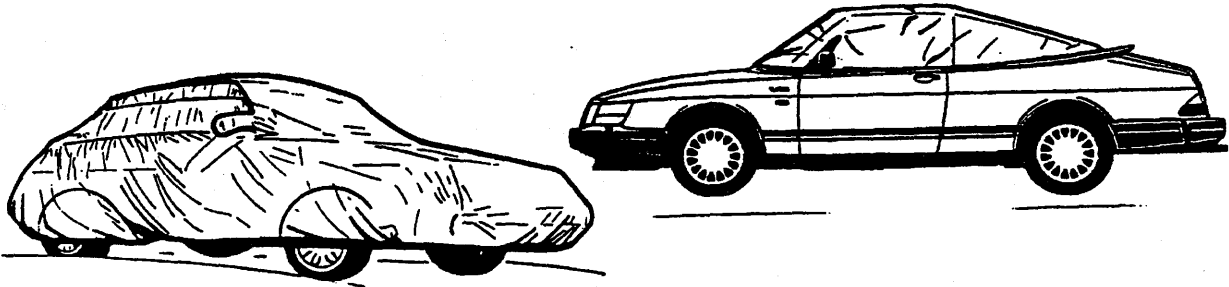

Description	Part Number	Application	Notes
Car Covers	02 48 468	9000 CD, 89-	Made of Kimberly-Clarke Evolution 3 fabric. NOT water proof.
	02 48 450	9000 5D, CS	
	02 48 443	900 CV 86-94	
	02 48 435	900 79-93	
	02 48 567	900 94-	



Subject: Rear Headrests 900, 81-90

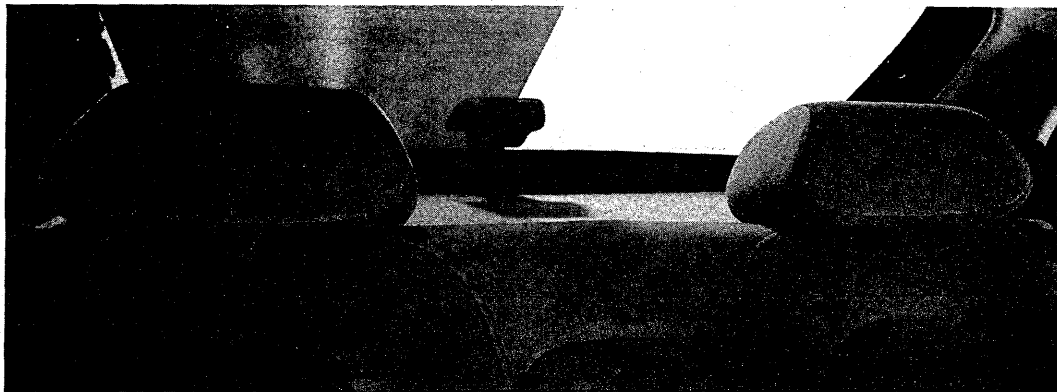

Description	Part Number	Application	Notes
HEADREST CUSHION	02 03 885	All	
Cover Cashmere C15	96 81 198	85	
Cover Bokhara Red C20	96 99 588	84-85	
Cover Sierra Tan C21B	95 33 910	85	
Cover Sierra Tan C21P	96 99 562	84-85	
Cover Sierra Leather C22	96 99 513	83-85	
Cover Bokhara Red C11	95 33 902	86-88	
Cover Tan All	95 33 910	86-88	
Cover Sierra Tan A23 & 24	96 99 562	86-88	
Cover Sierra Tan Leather A33	96 99 513	86-89	
Cover Red C23 & 24	96 99 588	86-88	
Cover Red C41 & 44	96 99 620	89-90	
Cover Labrador Grey E23 & 24	96 99 596	86-88	
Cover Grey E41 & 44	96 99 638	89-90	
Cover Buffalo Grey Leather E33	96 99 547	86-89	
Cover Marine Blue F11	96 88 797	88	
Cover Marine Blue F24	96 99 604	88	
Cover Blue F41 & F44	44 13 274	89-90	
Cover Tan G41 & G44	96 99 653	89-90	
Cover Cashmere B11	96 81 198	86-90	
Cover Colorado Red Leather C33	96 99 539	88-90	
Cover Labrador Grey E11	95 33 928	88	

NOTE: Additional Part Numbers on regular microfiche.



Subject: Rear Center Headrests 900, 94-

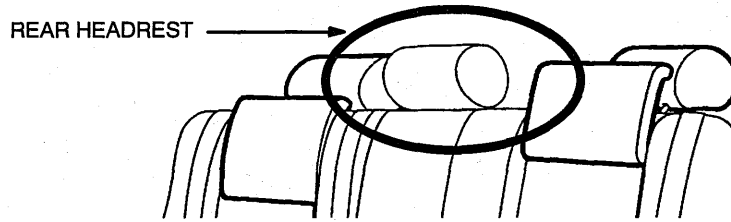

Description	Part Number	Application	Notes
HEADREST CORE	02 48 591	94- 900 3D/5D	
Covers			
Taupe Cloth	44 61 760		
Taupe Leather	44 61 695		
Light Grey Cloth	44 61 976		
Light Grey Leather	44 61 901		
Charcoal Cloth	44 61 554		
Charcoal Leather	44 61 489		
Sand Beige Leather	45 30 895		



Subject: Cup Holders

9000 Cup Holder

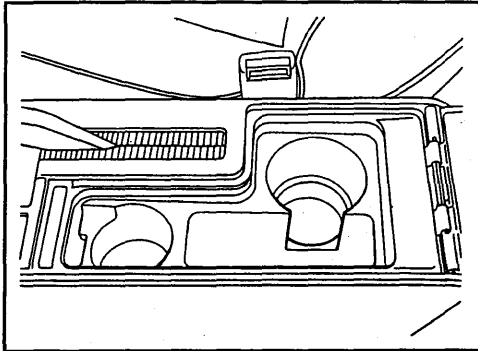

900 Cup Holder

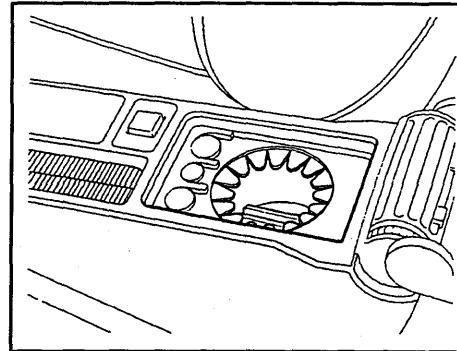

Cup holder in center console

Description	Part Number	Application	Notes
Cup Holders	02 48 740	900 3/5 Dr. 94-, Conv. 95-	
Cup Holders	02 48 757	9000 All	



Subject: Soft Boot Cover, 900 Convertible, M86-94

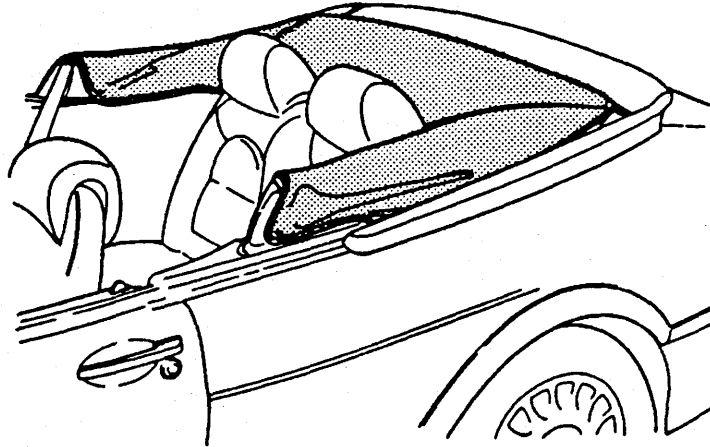

Description	Part Number	Application	Notes
Soft Boot Cover, Vinyl	02 81 543		900 CV 1986-94 Tan
Soft Boot Cover, Vinyl	02 81 550		900 CV 1988-94 Grey
Soft Boot Cover, Vinyl	02 81 568		900 CV 1987-94 Red



Subject: Dog Guard

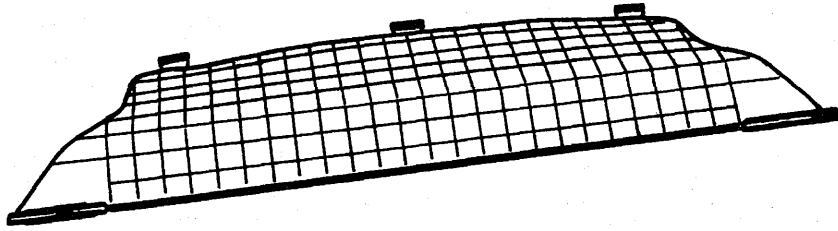

Description	Part Number	Application	Notes
Dog Guard	02 45 845	9000 M92 5D, C5	For cars without rear headrest
Mounting Kit	02 45 837		
Dog Guard	02 43 840	9000 5D, -91	
Dog Guard	02 43 493	900 3D, 5D 81-93	
Mounting Kit	02 43 501		
Dog Guard	02 48 617	900 3D, 5D 94-	



Subject: Luggage Net

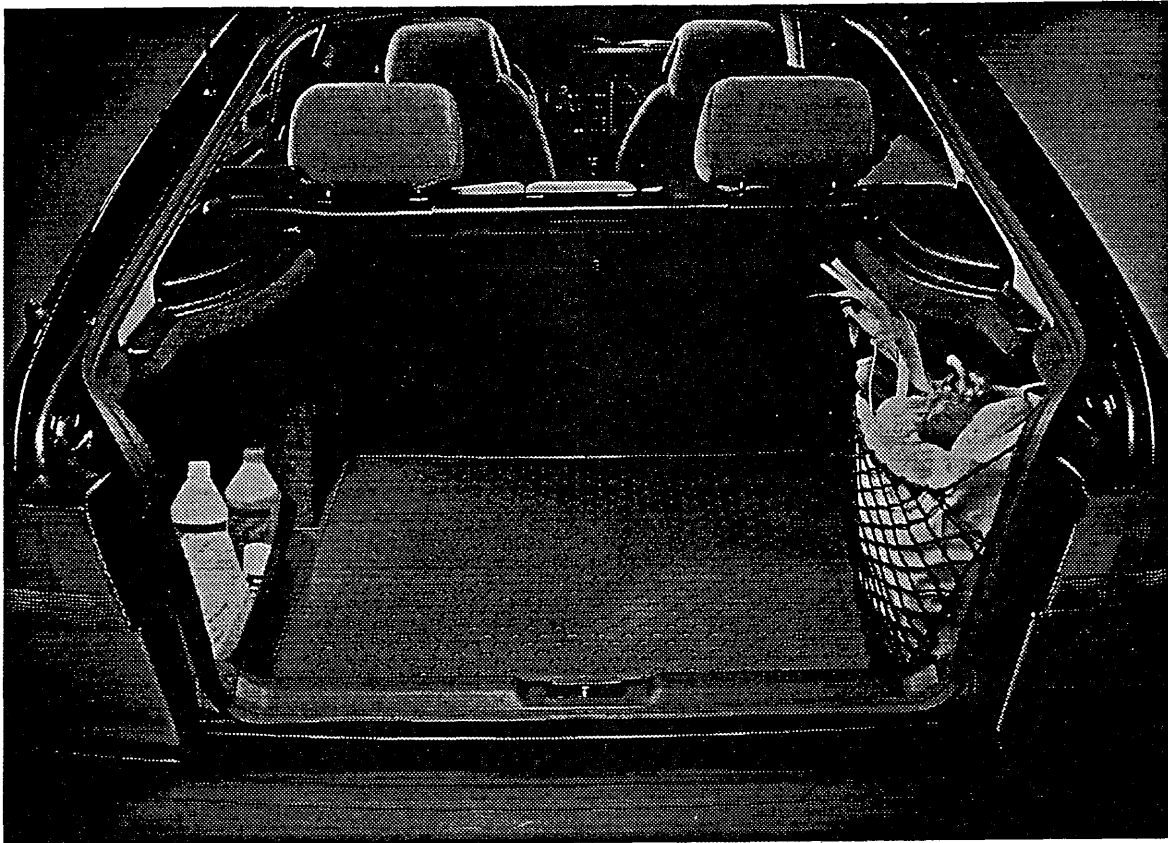

Description	Part Number	Application	Notes
Luggage Net	02 48 310	900 94- 3D, 5D	
Luggage Net	02 44 335	9000 5D 86-92	
Luggage Net	02 46 587	9000 CS 93-	
Interior Protection Bag	02 43 469	9000 CD 89-95	(Discontinued)



Subject: Cargo Mats

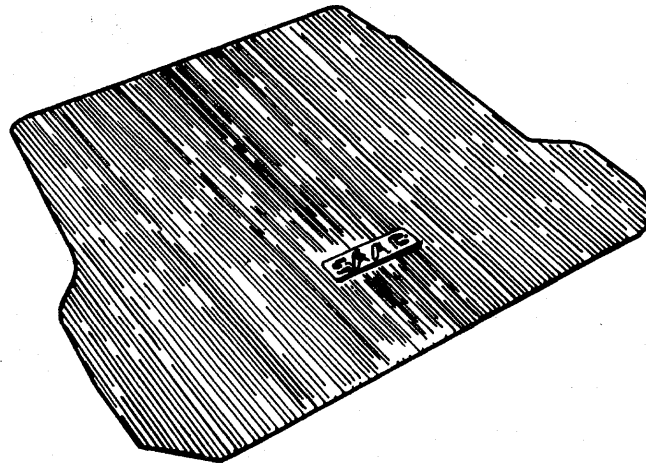

Description	Part Number	Application	Notes
Cargo Mats (Rubber)	02 48 302	900 94- 3D/5D	
Cargo Mats (Rubber)	02 43 428	9000 CD 89-	
Cargo Mats (Rubber)	02 72 179	9000 5D, CS All	
Luggage Compartment Protector (ABS Plastic)	02 44 574	900 81-93	
Luggage Compartment Protector	02 44 657	9000 5D/4D	



Subject: Storage Boxes (Not for cars with CD-Changers)

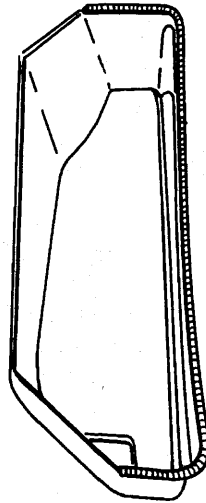

Description	Part Number	Application	Notes
Storage Boxes	02 48 328	900 94- 3D, 5D	
Storage Boxes	02 74 225	900 81-93, 3D	
Storage Boxes	02 74 217	900 81-93 2D, 4D Not CV	
Storage Boxes	02 74 233	9000 86-92 5D	
Storage Boxes	02 46 652	9000 93- CS	
Storage Boxes	02 43 915	9000 89- CD	
Orderly Cargo Stabilizer	02 50 506	All	



Subject: Dashboard Sunshade

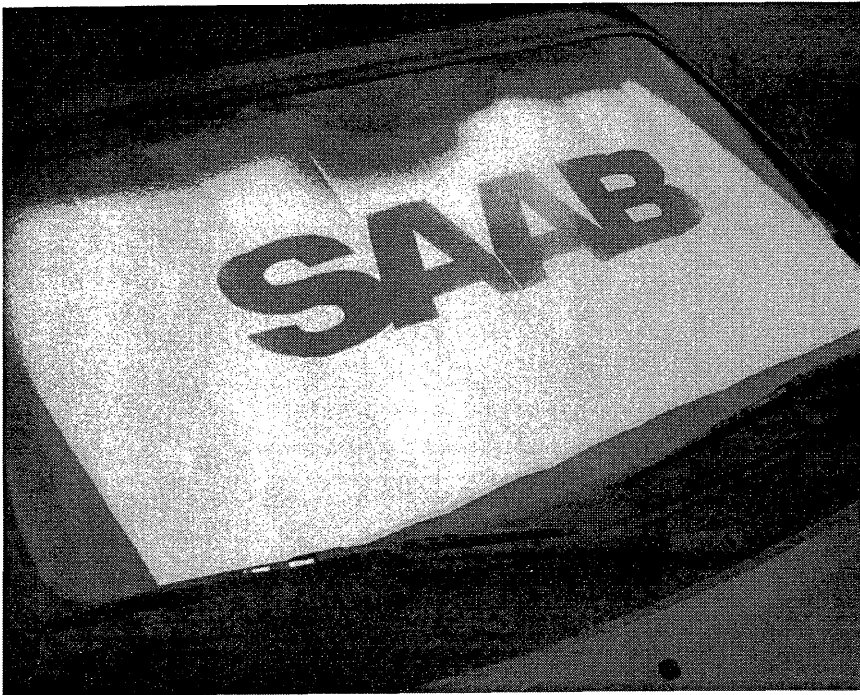

Description	Part Number	Application	Notes
Dashboard Sunshade	02 52 783	900 All, 9000 All	Reflective silver Mylar with polyfoam backing.



Subject: Radar Detector



Description	Part Number	Application	Notes
ESCORT SOLO Radar Detector	02 51 215	900 All, 9000 All	Cordless. Uses 2 AA batteries.
Power cord/Converter	02 51 223	900 All, 9000 All	Optional. For use with 02 51 215. NOTE: Use of any other power cord/converter will damage radar detector.
Accessory Plug	02 80 008	900 All, 9000 All	Replacement plug for use with those accessories equipped with loose-fitting plugs.
Firm-Fit Lighter Spacers	02 51 488	900 All, 9000 All	Metal sleeve that slides onto a loose-fitting 12-volt power plug to provide a secure fit. (pack of 2.)



Subject: Back-Up Alert

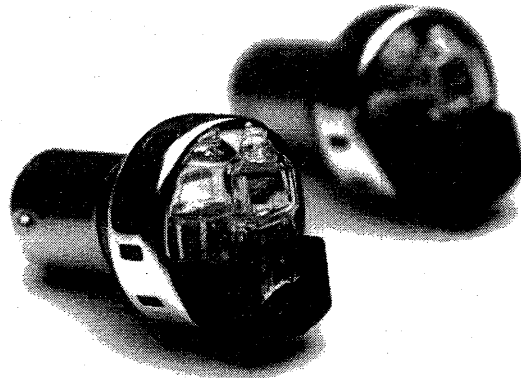

Description	Part Number	Application	Notes
Back-Up Alert	02 51 462	900 All, 9000 All	Replaces standard back-up bulb.



Subject: Emergency Aids

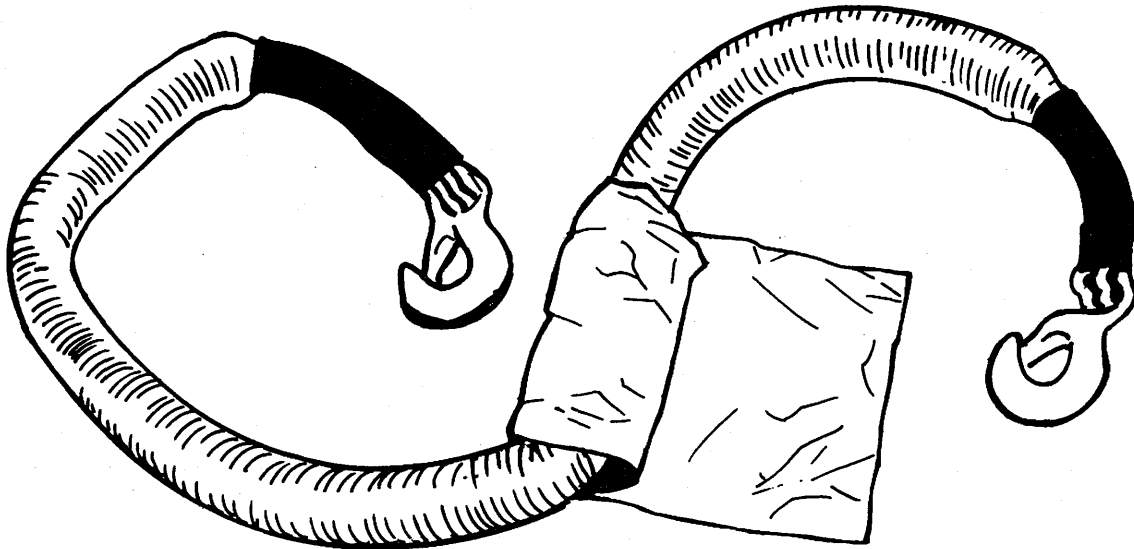

Description	Part Number	Application	Notes
Tire Gauge	02 50 514		Digital; 1/2 lb. increments
Warning Triangle Kit	02 11 565		Set of 3
First Aid Kit	02 79 117		
Tow Line	02 45 209		
Rechargeable Flashlight	02 46 686		Not for 9000 Models w/passenger air bag (Discontinued)
Booster Cables	02 49 912		



Subject: Winter Aids

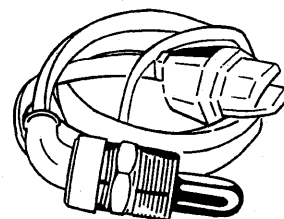
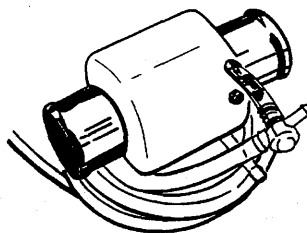
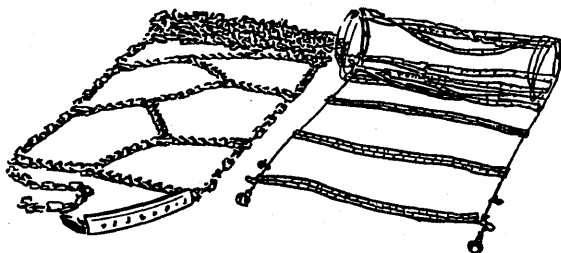

Description	Part Number	Application	Notes
Engine Block Heater	02 72 138	900 85-93, -94CV 9000 86-90	Easy thread in installation. 2.0 L + 2.1 L engines
• Cord Set	02 72 146		
• Heater to Engine Gasket	02 72 153		
Engine Block Heater	02 49 953	9000 90-, 900 94-, 95CV 4 Cylinder	(02 46 520) 2.3 L + 2.0 L engines
• Cord Set	02 49 961		
Engine Block Heater	02 50 001	All V6	
Tire Chains/Radial Cable	02 04 438	900, 900 All	
Tire Chains/Link Chain	02 45 324	900, 9000 All	
Windshield Washer Fluid Heater Kit	02 50 175	900 -93, -94CV All except turbo 9000 86-91	
Winter Wiper Blade 20"	02 50 456	900 94-, 95 CV-, All 9000 Front & Rear	Winter Blades Sold Individually
Winter Wiper Blade 18"	02 50 464	900 86-94 CV	
Winter Wiper Blade 16"	02 50 472	900-93	

**Subject: Car Care Products**

Description	Part Number	Application	Notes
All Purpose Cleaner	02 51 694	900 All, 9000 All	32 oz.
Alloy Wheel Cleaner	02 51 678	900 All, 9000 All	32 oz.
Bug and Tar Remover	02 51 710	900 All, 9000 All	32 oz.
Car Wash	02 51 652	900 All, 9000 All	16 oz.
Carnauba Cream Wax	02 51 660	900 All, 9000 All	16 oz.
Leather Cleaner	02 51 637	900 All, 9000 All	16 oz.
Leather Conditioner	02 51 645	900 All, 9000 All	16 oz.
Premium Glass Cleaner	02 51 702	900 All, 9000 All	32 oz.
Tire and Trim Dressing	02 51 686	900 All, 9000 All	32 oz.



Subject: Antifreeze/Coolant

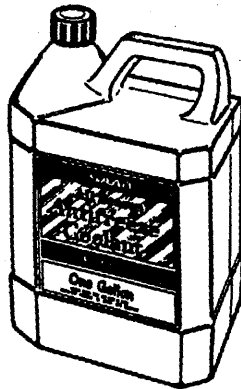

Description	Part Number	Application	Notes
SAAB Antifreeze/Coolant	02 48 583		1 = Case of 6 Gallons



SAAB

Saab Cars USA, Inc.
4405-A International Blvd.
Norcross, GA 30093

Saab PN 02 18 073 Effective 5/1/97