

Saab 9000

1995



Owner's Manual

saab-club.com



SAAB

Warning labels



Drive belt:
Warning for drive belt



Radiator fan:
Radiator fan may start at any time.



AC system:
Refrigerant under high pressure

Do not loosen or remove the AC system fittings before purging the AC system. Incorrect service methods may cause injury to personnel. **SYSTEM TO BE SERVICED BY QUALIFIED PERSONNEL ONLY.** For instructions, consult the Service Manual.

The AC system complies with SAE J639.

Charge: 950 g R134a

Compressor oil: 200 cc PAG Oil SK 20 or SAAB oil 4319752.

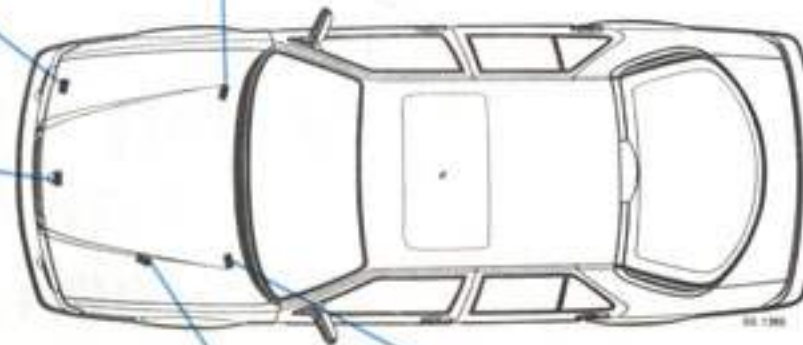

Battery:
Contains corrosive sulphuric acid (40%)

- Produces **EXPLOSIVE GASES** when in use or being charged.
- Always shield eyes and face when working with battery.
- Cigarettes, naked flame and sparks can cause battery to explode.
- See the Owner's Manual before using jump leads.
- The battery can **CAUSE SEVERE BURNS** from the sulphuric acid it contains .
- Do not tilt the battery
- Avoid contact with eyes, skin and clothes.
- In case of accident, rinse immediately with water and seek medical attention.

KEEP OUT OF REACH OF CHILDREN



Brake system:
Clean filler cap before removing.
Use only DOT 4 fluid from sealed container.

WARNING **SRS**

This vehicle has a Supplementary Restraint System (SRS), or airbag, for both front occupants. It inflates only during certain frontal collisions. It is NOT designed to inflate during rollovers or in rear, side or minor frontal collisions. ALWAYS WEAR YOUR SEAT BELT to help you obtain the correct position for SRS inflation and to help protect you during all types of collisions.

NEVER use a child seat in the front seat of this vehicle. Taking a child seat forward could be seriously injured by direct contact with the SRS, if it inflates. Always child restraints only in the rear seat.



For more information see your Owner's Manual.

Passenger's airbag:

This vehicle has a Supplementary Restraint System (SRS), or airbag, for both front-seat occupants. It inflates only during certain frontal collisions. It is NOT designed to inflate during a rollover or in rear, side or minor head-on collisions. ALWAYS WEAR YOUR SEAT BELT to help you obtain the correct position for SRS inflation and protect you in all types of collision.

NEVER fit a child safety seat in the front seat of this vehicle. Children in child seats could be seriously injured by direct contact with the SRS, if it inflates.

Install child restraints in the rear seat only.

For further information consult your Owner's Manual.

WARNING

- Jack is designed only for changing a tire or mounting tire snow chains.
- Car must be level and jack must be placed on firm and level ground.
- Never crawl underneath car when it is jacked up.

Jack (label in certain markets only)

The jack is intended for use only when changing wheels or fitting snow chains.

The car must be level and the jack must be placed on a firm, level surface.

Never crawl under the car when it is raised with the jack.



Airbag on passenger side

Never use child car seat in the front seat.

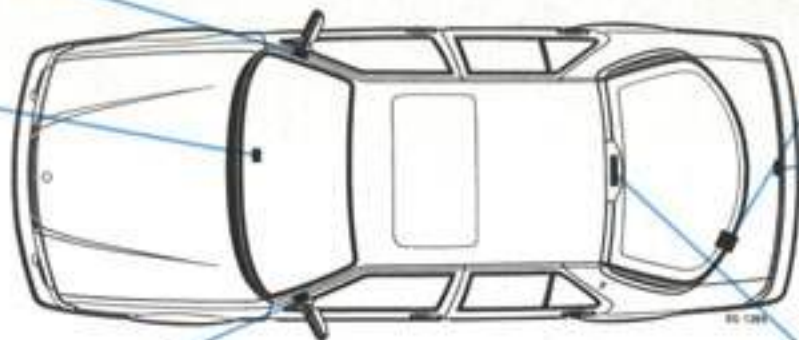

WARNING

Safe working load 900 kg. To be used on level firm ground only. For jacking instructions, see your Owner's Manual. Saab Automobile AB



Jack:
Safe working load: 900 kg. Use only on level, firm ground. For further jacking instructions, see your Owner's Manual.

WARNING **SRS**

This vehicle has a Supplementary Restraint System (SRS), or airbag, for the front-seat occupant(s). It inflates only during certain frontal collisions. It is NOT designed to inflate during a rollover or in rear, side or minor frontal collisions. ALWAYS WEAR YOUR SEAT BELT to help you obtain the correct position for SRS inflation and to help protect you during all types of collisions.

When you turn the ignition key to "ON", the SRS light in the instrument panel should come on briefly. If it does not, or if it comes on when the car is in motion, the SRS may not work properly. See your SAAB dealer for service information. For more information see your Owner's Manual.

Before service or scrapping of the SRS components, see Owner's Manual.

REGULAR MAINTENANCE OF THE SRS IS NOT REQUIRED.



Driver's airbag

This vehicle has a Supplementary Restraint System (SRS), or airbag, for the front-seat occupant(s). It inflates only during certain frontal collisions. It is NOT designed to inflate during a rollover or in rear, side or minor head-on collisions. ALWAYS WEAR YOUR SEAT BELT to help you obtain the correct position for SRS inflation and protect you in all types of collision.

When you turn the ignition switch to "ON", the SRS light in the instrument panel should come on briefly. If it does not, or if it comes on when the car is in motion, the SRS may not work properly. See your SAAB dealer for service information. For further information, consult your Owner's Manual.

Before service or scrapping of SRS components, see the Owner's Manual.

REGULAR MAINTENANCE OF THE SRS IS NOT REQUIRED.

WARNING **LONG LOAD**

Max. weight 15 kg. Max. length 2 m. Do not load in excess of these limits. The load must be distributed evenly. Do not load in excess of these limits. Do not load in excess of these limits. Do not load in excess of these limits.

ATTENTION **LONGUE CHARGE**

Max. poids 15 kg. Longueur max. 2 m. Ne pas charger au-delà de ces limites. Répartir uniformément la charge. Ne pas charger au-delà de ces limites. Ne pas charger au-delà de ces limites. Ne pas charger au-delà de ces limites.

Long load
Max. weight 15 kg
Max. length 2 meters

Fasten the load well to prevent it moving and causing personal injury when braking. Protect sharp edges

FASTEN LOAD.
See Owner's Manual.



This Owner's Manual provides some practical advice on driving and looking after your car. The Saab 9000 range consists of the following body shapes with different engines:

- 9000 CS - 5-door Hatchback model with 2.0-litre, 2.3-litre and 3.0-litre V6 fuel injection engine or 2.0-litre and 2.3-litre turbo-charged engine.
- 9000 CD - 4-door Saloon model with 2.0-litre, 2.3-litre and 3.0-litre V6 fuel-injection engine or 2.0-litre and 2.3-litre turbo-charged engine.

Read through the manual before taking the car out for the first time and then keep it in the car for future reference.

A list of contents is provided for each section of the manual and there is also a comprehensive index at the back.

Supplied with the car is a service book, which also contains important information on warranty conditions.

WARNING

Warning text on a yellow background indicates a danger of bodily injury if the recommendations are not followed.

IMPORTANT

Warning text on a blue background indicates a danger of damage to your car if the recommendations are not followed.

Since the policy at Saab Automobile AB is one of continual improvement, we retain the right to incorporate modifications and alter specifications during production without prior notice.

Best wishes, Saab Automobile AB

The radio shown in some of the photographs in this booklet is not included as standard equipment for the car.



Instruments and controls

Indicator and warning lights . . .	6
Instruments	9
Trip computer.	10
Switches	15
Climate-control systems. . . .	19
Manual climate-control system	19
Automatic climate-control (ACC) system	21
9000 Audio System (option) .	27

6 Instruments and controls

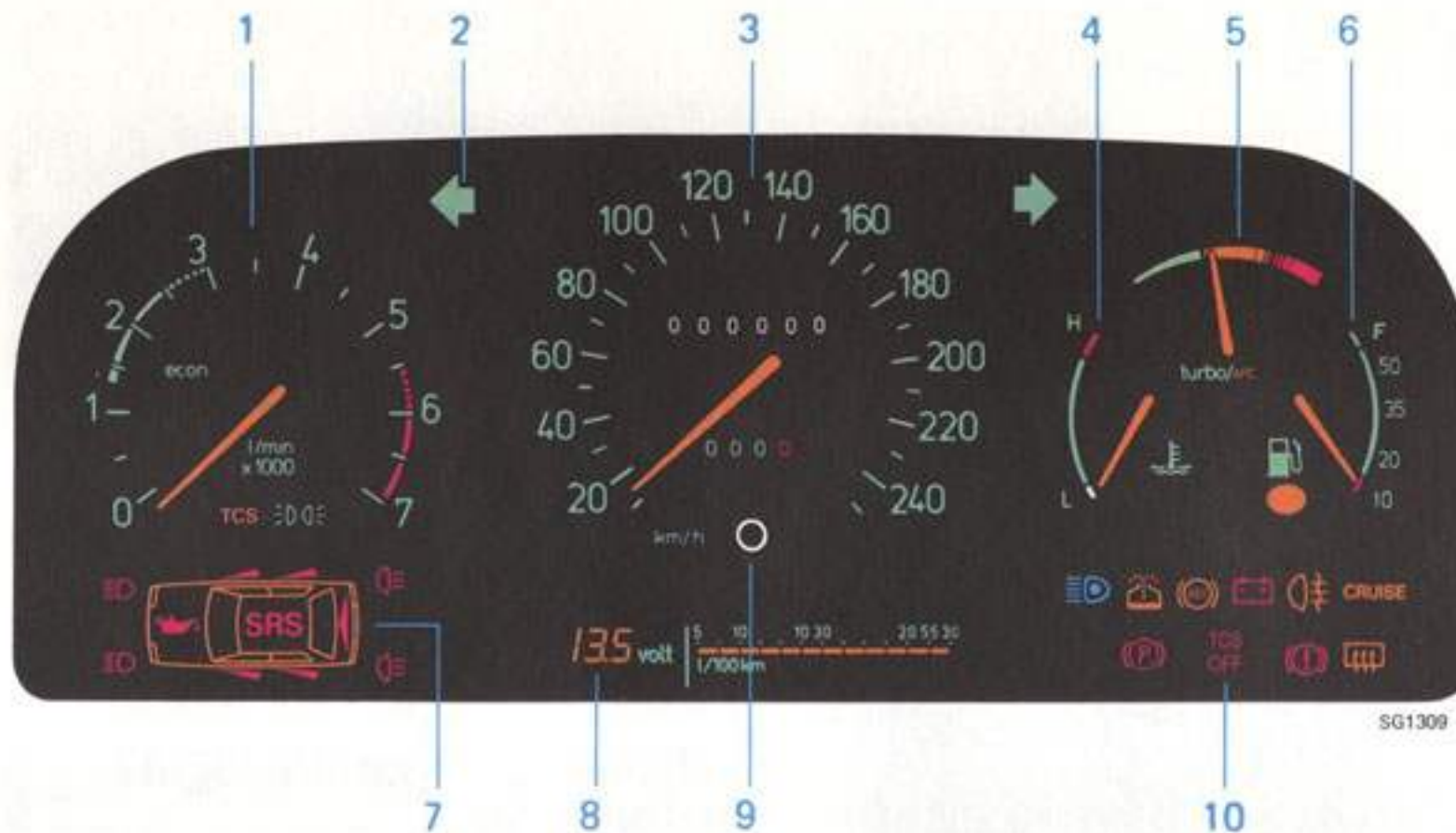

SG1309

Main instrument display panel

- | | |
|---|---------------------------------|
| 1 Rev counter | 6 Fuel gauge |
| 2 Direction indicator repeater light | 7 Pictogram |
| 3 Speedometer incorporating odometer and trip meter | 8 EDU trip computer display |
| 4 Temperature gauge | 9 Trip meter reset knob |
| 5 Pressure gauge (Turbo only) | 10 Indicator and warning lights |

Indicator and warning lights

All the warning lights come on as the ignition is switched on. The lights should all be extinguished as soon as the engine has been started.

**Main beam indicator light**

This light will show when the main beam is on, see page 15.

**Washer fluid indicator light**

This light will come on when the washer fluid in the reservoir needs replenishing, see page 89.

**ABS warning light**

This light comes on if a fault arises in the Anti-Lock Brake System. Conventional braking will still be available but without the Anti-Lock System.

Have the Anti-Lock Brake System checked by an authorized Saab dealer without delay, see page 69

**Charging warning light**

This light will come on if the battery is not being charged. If it comes on while you are driving, stop the car immediately and switch off the engine.

Check the engine drive belt. A broken belt means that the engine will not cool properly, the battery will not be charged and power steering will be lost.

Fuel warning light

The lamp under the fuel gauge lights when there is less than 10 litres (2 imp. gal) of fuel left in the tank.

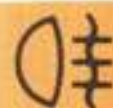
**Rear fog lamp indicator light**

This light will show when the rear fog lamp is switched on, see page 16.

**Handbrake warning light**

This light will show when the handbrake is applied.

**Indicator light, Traction Control System, OFF**

The indicator light goes on when the Traction Control System is switched off with the TCS OFF button.

IMPORTANT. The Traction Control system is automatically engaged every time the engine is started, see page 70.

The indicator light also goes on when there is a fault in the Traction Control system. In this case the light cannot be turned off by pushing the TCS OFF button. The system should be checked by an authorized Saab workshop.

**Traction Control System indicator light (option)**

This light, in the rev counter, comes on to indicate that the Traction Control System is in operation, i.e. when the grip of the wheels on the road is less than that needed to provide the desired acceleration. At the same time, you will notice that the engine is less responsive to the accelerator.

When the Traction Control System comes into operation it is an indication that the road surface is slippery, so drive with extra care when the indicator light is on.

The Traction Control System contributes to driver comfort and safety but not must be seen as a means of driving the car faster with impunity. The same care must be taken when cornering and driving on slippery roads as would normally be the case, see page 70.

CRUISE

Indicator lamp, Cruise Control System

The lamp is lit when the cruise control is engaged.

**Brake warning light**

The brake warning light will come on if the brake fluid level falls too low. If the light comes on while you are driving, stop the car immediately and check the level of brake fluid in the reservoir. On cars with ABS brakes, the light will also come on in combination with the ANTI LOCK warning light if there is a drop in pressure in the brake servo system. If this happens, power assistance will disappear suddenly after a few braking operations.

WARNING

If brake servo effect is lost, braking power will be heavily reduced and much higher pedal pressure will be required to apply the brakes. Never drive the car when this warning lamp is on.

The brake system should be inspected and put right immediately by an authorized Saab garage.

**Indicator light for rear-window heating**

This light will show when the rear-window heating is switched on.

Pictogram

The pictogram will indicate if any door, including the boot lid, is not properly closed and if a bulb for the dipped headlights, stop lights or rear lights has blown. The pictogram also incorporates the oil pressure warning light.

Pictogram**Oil pressure warning light**

This light will come on if the engine oil pressure should fall too low. If the light flashes or comes on while you are driving, stop the car immediately, switch off the engine and check the oil level.

The car must not be driven while this light is on.

SRS**Warning light for airbag - Supplementary Restraint System (SRS) (option)**

This lamp will flash or shine with a steady light if a fault develops in the SRS system. A fault indicated in this way could mean failure of the SRS to activate in a collision. The system should be inspected and put right immediately by an authorized Saab garage.

The light will light up for a few seconds when the ignition switch is turned to the start or drive position, but should be extinguished when the engine has started.

Instruments

Rev counter

The rev counter shows the engine speed in thousands of revs per minute. For maximum fuel economy, the needle should be kept within the green zone. The needle may briefly enter the broken red zone but must never be allowed to enter the solid red zone.

A safety cut-out function (fuel shut-off) prevents the engine speed exceeding approximately 6,000 r/min.

Speedometer, odometer and trip meter

The odometer records the distance in kilometres and the trip meter the distance in kilometres and tenths.

Pressure gauge (Turbo only)

The pressure gauge indicates the pressure in the inlet manifold. When the engine is only lightly loaded and during engine overrun (engine braking) a depression will be present in the inlet manifold and the needle on the gauge will be within the white zone. At higher engine speeds and when the engine is under a greater load, the turbo-charger will boost the pressure in the inlet manifold and the needle will enter the orange zone. Under normal conditions, the needle should not enter the red zone as a safety cut-out system will limit the charging pressure to protect the engine. However, under certain atmospheric conditions, the needle may just enter the red zone, which does not mean that the system is malfunctioning in any way. But if the needle repeatedly enters the red zone and a loss in engine power is also experienced because the safety cut-out system is limiting the charging pressure, the car should be taken to an authorized Saab workshop without delay.

Temperature gauge

This gauge displays the temperature of the engine coolant. The pointer should normally be in the middle of the gauge.

If the temperature gauge needle approaches the red section (this may occur when the ambient temperature is extremely high or at very high engine loads), the highest possible gear should be selected to re-

duce the engine speed as much as possible. Avoid changing down. If the pointer should move into the red section in spite of these measures, stop the car and let the engine idle.

If the needle moves into the red section repeatedly, stop as soon as possible and check the coolant level.

Turbo models: Check whether the CHECK RADIATOR LEVEL warning lamp lights up. This indicates that the coolant level in the expansion tank is low.

Clock

The clock, situated to the right of the main instrument display panel, can be set to the correct time by means of the knob in the middle of the dial.

WARNING

Consult your Saab dealer before adding any additional wiring, as this could cause damage to Electronic Control Units in the car.

Trip computer

Your car is equipped with a trip computer and EDU (Electronic Display Unit). The SCC (Saab Car Computer) is available as optional equipment.

The EDU trip computer incorporates a varying range of functions, depending on the model variant of your car and its level of equipment. The two control buttons for the computer are below the clock, and there is an electronic display below the speedometer, providing the following information:

- Average fuel consumption
- Current fuel consumption.
In manual cars, this function is displayed as a horizontal bar in the right-hand section of the display.
- Range of the car, based on the amount of fuel left in the tank and the average fuel consumption.
When the range falls below about 30 miles (50 km) and one of the other functions has been selected, the arrow on the display will start to flash.
- Outside temperature.
If the outside temperature is between +3°C and -3°C when the ignition is switched on, it will automatically be displayed instead of the battery voltage. The display will then continue to show the outside temperature until either another function is chosen with the INFO button or the outside temperature rises above +6°C or drops below -6°C.



Control buttons for the EDU trip computer ^{SG 548}

The outside temperature function is also active while the car is driven on the road.

- Battery voltage
The battery voltage will always be displayed after the ignition key has been turned to the drive position. On starting, the value of the lowest voltage recorded will be displayed. Once the car is running, the computer will revert to the last function selected. By noting the voltage drop on starting, an assessment can be made of the condition of the battery (additional information on the battery is given in the 'Battery' section).

These items of information are shown in the left-hand part of the display below the speedometer. To change the function of the display, press the INFO button repeatedly until the desired information is obtained.



The EDU trip computer display (manual cars)



The EDU trip computer display (automatic cars)

The following warnings will be displayed automatically in the right-hand part of the display:

- CHECK ENGINE
- CHECK RADIATOR LEVEL

When you switch on the ignition, all three warnings should come on and then go off, one at a time, within about four seconds.

CHECK ENGINE. The appearance of this warning on the display indicates a malfunction in the fuel injection system or ignition system. The car may still be driven, but with somewhat diminished performance. Have the systems checked without delay by an authorized Saab workshop.

CHECK RADIATOR LEVEL. This will come on if the level of coolant in the expansion tank falls too low.

PRND 321. On cars with automatic transmission, the selector lever position is indicated by an orange bar under the corresponding number or letter.

Selecting the units

To select the desired combination of units, depress the INFO and R buttons simultaneously and hold them depressed for at least four seconds. Each time the buttons are depressed, one of the four following groups of measurement units will be selected:

- litres/100 km, kilometres, °C
- MPG (US gal), miles, °F
- MPG (imp. gal.), miles, °F
- MPG (imp.gal.), miles, °C

Resetting

To reset the display for average fuel consumption and range of the car, depress button R and hold it depressed for at least four seconds. The appearance of - - - in the display indicates that it has been reset. After resetting, calculation of the average fuel consumption starts afresh from 10 litres/100 km. The display will be reset automatically after 1,342 litres of fuel have been used or the car has been driven an aggregate of 6,512 miles (10,480 km).

Switching the display on/off

To switch off the display, press the R and INFO buttons simultaneously and release within four seconds. The display will come on again if either of these buttons is depressed, if the ignition is switched on/off or if one of the check function warnings is initiated.

Error codes

If one of the trip computer sensors should develop a fault, ERR will appear on the left part of the display for a few seconds, immediately after the ignition has been switched on. The code will reappear if the function with the defective sensor is selected. Have the fault rectified by an authorized Saab workshop.





Trip computer SCC

SG1204

The SCC trip computer incorporates the following functions:

- DIST. TO DEST. (distance to destination)
- AVER. SPEED (average speed)
- SPEED WARN. (speeding alarm)
- CLOCK
- ARRIVAL (time of arrival at destination)
- ALARM











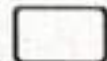

Use this button  to select the following functions:
DIST. TO DEST.
AVER. SPEED
SPEED WARN.

Use this button  to select these functions:
CLOCK
ARRIVAL
ALARM

WARNING

The various SCC modes should be set while the car is stationary.

CLOCK

- 1 Select CLOCK   
- 2   
Hold the SET button depressed for two seconds (the figures will start to flash)
- 3   
increase / decrease
Set the desired time.
Press the appropriate button repeatedly until the required time is set. Hold the button depressed to change the figures more rapidly.
- 4   
Depress the SET button briefly to end the setting procedure and start the clock.

To reset the clock to zero, hold the SET button depressed for four seconds until the display shows 00.00.

The time can be displayed when the ignition is not switched on by pressing the INFO button on the SCC. The time will be displayed as long as the button is depressed.

ARRIVAL









This function is interconnected with DIST. TO DEST and AVER. SPEED. If you want to know your estimated time of arrival, set the distance to your destination (DIST. TO

DEST.) and your estimated average speed (AVER. SPEED). The estimated time of arrival will then be adjusted continuously during your journey according to the average speed you maintain.

You can also see the average speed you must maintain in order to arrive at your destination at a particular time. You then enter the distance to your destination and the desired arrival time. This calculation can be performed as long as the DIST. TO DEST. is more than 0.

NOTE: This average speed will only be displayed if you subsequently select AVER. SPEED with the  button within 15 seconds of entering the distance and time. If you only set the distance to your destination, the estimated time of arrival will be displayed on the basis of your average speed after having driven 500 metres. Until you have covered 500 metres, the display will show - - - -.

To set an estimated time of arrival on the basis of DIST. TO DEST. and AVER. SPEED, proceed as follows:

- 1 Select ARRIVAL   
- 2   
Hold the SET button depressed for two seconds (the figures will start to flash).
- 3   
decrease / increase
Enter the desired time of arrival. Press the appropriate button repeatedly until

the required time is set. Hold the button depressed to change the figures more rapidly.



Depress the SET button briefly to store the setting.

To clear the display, hold the SET button depressed for four seconds until the display shows - - - -.

If the ARRIVAL function has been used in conjunction with DIST. TO DEST. and AVER. SPEED, the arrival time will be frozen when the DIST. TO DEST. countdown reaches 0.0.

The AVER. SPEED function continues to show your average speed.

ALARM



Hold the SET button depressed for two seconds (the figures will start to flash).



decrease / increase

Set the desired time. Press the appropriate button repeatedly until the required time is set. Hold the button depressed to change the figures more rapidly.

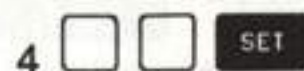

Press the SET button briefly to store the time.

The alarm beeps five times in five seconds followed by five seconds of silence. This cycle is repeated five times.

The alarm sounds even if the ignition is not switched on.

The alarm is acknowledged by briefly depressing any of the SCC's three buttons.

To activate an alarm time that has been set previously, hold the SET button depressed for two seconds until the figures start flashing, then briefly press the SET button.

To reset the alarm, hold the SET button depressed for four seconds until the display shows - - - -.

DISTANCE TO DESTINATION

This function is interconnected with ARRIVAL and AVER. SPEED.

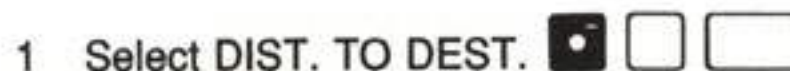

Hold the SET button depressed for two seconds (the figures start to flash)



decrease / increase

Set the desired distance in kilometres
Press the appropriate button repeatedly until the required distance is set. Hold

the button depressed to change the figures more rapidly.

Set only whole kilometres.

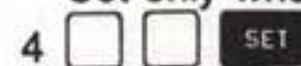

Press the SET button briefly to store the distance. The display now also shows tenths of a kilometre.

To reset, hold the SET button depressed for four seconds until the display shows 0.0.

If the DIST. TO DEST. function has been used in conjunction with AVER. SPEED and ARRIVAL, the countdown will stop at 0.

The ARRIVAL time freezes when the countdown reaches 0.

The AVER. SPEED function continues to show your average speed.

The DIST. TO DEST. function cannot be calculated from AVER. SPEED and ARRIVAL.

AVERAGE SPEED

This function is interconnected with DIST. TO DEST. and ARRIVAL.

The average speed is displayed even if DIST. TO DEST. and ARRIVAL are not activated. Switching off the ignition does not reset the average speed function.













It is reset when DIST. TO DEST. is set.

To reset, hold the SET button depressed for four seconds until the display shows 0.

After resetting, the display will show your speed during the first 500 metres you cover and then the average speed for this dis-

14 Instruments and controls













tance. To enter an average speed which is to interact with DIST. TO DEST. or ARRIVAL, proceed as follows:

- 1 Select AVER. SPEED   
- 2   
Hold the SET button depressed for two seconds (the figures start to flash).
- 3   
decrease / increase
Set the desired average speed. Press the appropriate button repeatedly until the required speed is set. Hold the button depressed to change the figures more rapidly.
- 4   
Briefly depress the SET button to store the setting.
An average speed set in this way will change to the actual average speed after 15 seconds.

If the AVER. SPEED function has been used in conjunction with DIST. TO DEST. and ARRIVAL, AVER. SPEED will continue to display the average speed after DIST. TO DEST. has counted down to 0. The ARRIVAL time is frozen in the display when DIST. TO DEST. has counted down to 0.

SPEEDING ALARM

The speeding alarm can be set between 1 and 200 km/h (1 - 125 mph)

- 1 Select SPEEDING ALARM   
- 2   
Hold the SET button depressed for two seconds (the figures start to flash)
- 3   
decrease / increase
Set the desired speed. Press the appropriate button repeatedly until the required speed is shown. Hold the button depressed to change the figures more rapidly.
- 4   
Briefly depress the SET button to store the setting.
A beep will sound every seven seconds whenever the car is travelling faster than the preset speed.

To deactivate the speeding alarm, hold the SET button depressed for four seconds until the display shows - - - -.

To activate a previously set speeding alarm, hold the SET button depressed for two seconds until the figures start to flash, then briefly depress the SET button.

CHANGING THE UNITS OF MEASUREMENT



Hold the buttons depressed simultaneously for at least four seconds to change the groups of measurement units:

- km, km/h, 24-hour clock
- miles, mph, 12-hour clock (AM, PM)

Automatic conversion of the preset values takes place when the units are changed.

Switches

Parking lights and headlights

The lighting is off

Note that the instrument illumination is lit only when outside lights are on.

Parking lights

The parking lights can be switched on irrespective of the position of the ignition key. Parking lights should only be used when the car is stationary.

Switch for parking lights and headlights

Headlights

The headlights can be switched on only when the ignition switch is in ON position. N.B. The headlights will be extinguished automatically when the ignition switch is turned to the LOCK position. The parking lights may still be switched on in this position.

Main/dipped beam

To change from main beam to dipped beam or vice versa, lift the stalk towards the steering wheel.

Headlight flashing

To flash the headlights, move the stalk towards the steering wheel. If the light switch is in the headlight position, change-over from main beam to dipped beam or vice versa will take place. In the OFF position, the main beam will be switched on until the stalk is released.

Headlight beam-length adjustment

Some variants are equipped with a system for adjusting the length of the beam from the headlights when this is affected by the way in which the car is loaded. The system comprises an actuator motor at each headlight and a switch on the fascia. The switch, which must not be operated unless the ignition is on, has the following four positions:

- 0 - One to three occupants (no more than one adult in the back) and no luggage.
- 1 - Two or three passengers in the back (and even a front-seat passenger) and a maximum of 30 kg of luggage.
- 2 - Two or three passengers in the back and 40 - 90 kg of luggage in the boot.



SG 366

16 Instruments and controls

- 3 - a) Maximum load in boot and one or two occupants.
 b) Three or four occupants and their luggage plus a caravan or trailer attached.

Direction indicators

To switch on the direction indicators, move the stalk up or down. The stalk has a spring-loaded position for use of the indicators for changing lanes or overtaking. In the fixed position, the indicators will remain on until cancelled automatically by the steering wheel. The respective repeater light on the instrument panel will flash at the same rate as the direction indicators.

If one of the double bulbs in the rear direc-

Switch for adjustment of headlight beam-length



SG 509

tion indicators burns out, the other bulb will flash at twice the normal rate.

Reversing lights

The reversing lights come on automatically when reverse (R) gear is engaged.

Instrument illumination

The brightness of the instrument illumination can be varied by means of the dimmer control located on the left of the facia.



Rear fog light

The rear fog light on the Saab 9000 CD is located in the left-hand lamp on the boot lid. On the Saab 9000 CS model, the rear fog light is incorporated in the full-width light panel between the rear light clusters. It is switched on by means of the switch on the instrument panel. The rear fog light operates only when the headlights are on.

Make sure that you are familiar with the law regarding the use of rear fog lights.

WARNING

Avoid following the rear lights of a vehicle in front in conditions of poor visibility. If the vehicle in front brakes suddenly, it could lead to an accident and consequent injury.

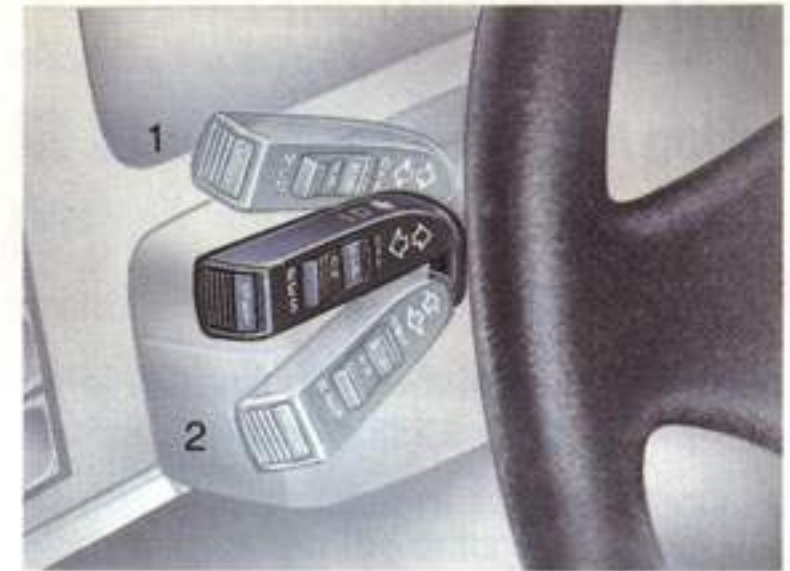

SG1195

Stalk switch for main/dipped beam and direction indicators

- 1 Indicators for right turn
- 2 Indicators for left turn



Hazard warning light switch

SG1170



Hazard warning lights

When the switch located to the right of the clock is depressed, all four direction indicators will flash simultaneously. An indicator light in the switch and both direction indicator repeater lights on the instrument panel will also flash.

The hazard warning lights should only be used if, because of a collision or breakdown, the car constitutes a danger or obstruction to other road users.

WARNING

Do not forget to place a warning triangle at the side of the road about 50-100 yards behind the car so that vehicles approaching from behind are warned in good time. Where visibility is limited, such as round a bend in the road or on the crown of a

hill, the triangle should be placed at a greater distance from the car.

A warning triangle is supplied with the car and stored under the floor panel in the luggage compartment.

Stalk switch for wipers and washers

The stalk switch for the wipers and washers has the following positions:

- 1 Windscreen wipers, intermittent operation. The wipers will make a double sweep every few seconds. This function is particularly useful in light rain or drizzle.
- 2 Windscreen wipers, low speed.
- 3 Windscreen wipers, high speed.

Stalk switch for wipers and washers





SG1196

For operation of the washers and wipers for the headlights and windscreen, lift the stalk switch towards the steering wheel. This function will operate irrespective of the position of the stalk.

Rear window wiper/washer, 9000 CS (optional equipment)

The rear window wiper/washer is operated by the same stalk as for the windscreen and headlamp wiper/washers.

This stalk has two additional positions, ON/OFF  and . Select the ON position for intermittent operation.

Select the position  for wash/wipe operation. After a few sweeps of the window the wiper will revert to intermittent operation if this has been selected.

Stalk switch for rear window wipers and washers (9000 CS)



SG1168



Switch for interior lighting

SG 369

- 0 Lighting off.
- 1 Lighting comes on when a door is opened.
- 2 Lighting on continuously.

Interior lighting

The lighting inside the car consists of a dome light, a light on the rearview mirror, a reading light for the front seat passenger, two reading lights for rear seat passengers and door lights on all doors. The respective door light comes on automatically when the door is opened.

The overhead panel incorporates the switch for the dome light and the front reading light and switch. The reading lights for the rear seat passengers incorporate their own switches. The reading lights can be switched on only when the ignition switch is in position ON.

The interior light has a delayed switch-off. When the switch for the interior lights is in position 1, the lighting will be switched off either by a time-delay relay, 15 seconds after the last door has been closed, or when the ignition switch has been turned to position ON.

Luggage compartment lighting

The luggage compartment lighting is switched on/extinguished automatically when the luggage compartment door is opened/closed. The lighting can also be switched off by moving the switch to the middle position.



Fog lights

Some variants have extra fog lights integrated in the front spoiler. The switch is located under the headlight switch.

Make sure that you are familiar with the law regarding the use of fog lights.

Climate-control system

Three climate-control systems are available: a manually controlled system without air conditioning (AC), a manually controlled system with AC, and an automatic system known as Automatic Climate Control (ACC).

For maximum AC and ACC efficiency, all windows and the sunroof, if fitted, should be closed.

Fresh air is drawn in through an intake at the bottom of the windscreen. It flows through a filter into the climate-control system and is then admitted into the cabin as required.

On 9000 CD models, the air is evacuated through a grille mounted in the right-hand side panel of the boot. 9000 CS models have two air outlets on each side of the rear window.

Manual climate-control system



Fan

The amount of air admitted to the car is controlled by the fan switch (four speeds). To increase the air flow, turn the switch clockwise.

TEMP Temperature control

The temperature control provides infinitely variable control (between the limits) of the temperature of the supply air. Turn the knob clockwise to increase the temperature.

DISTR Air distribution

The air distribution control is used to direct the supply air to the defroster, panel and floor vents. The control may be set to a number of intermediate detent positions between the four main settings, to distribute the air between the floor and the defroster vents or between the floor and the panel vents.

Manual-system controls



SG1052



Maximum flow if air to windscreen and side windows (defroster position)



Maximum flow of air to floor



Maximum flow of air through panel vents



All vents closed

Joysticks on the panel vents enable the direction of the air flow to be selected as desired (for instance, in very cold weather it may be advisable to direct the air flow onto the side windows to enhance the the defrosting effect). The knobs on the panel vents enable the amount of air admitted to be adjusted for each vent individually.



Heated rear window and door mirrors

The switch for the rear-window and door-mirror heating is incorporated in the control unit for the climate-control system. When the heating is switched on, an indicator light on the instrument panel will show. Switch off the heating as soon as the rear window is free from ice and mist. The heating will be switched off automatically after 10 - 15 minutes.

Refrain from placing sharp or hard objects on the rear parcel shelf, to avoid damaging the heater wires.

Do not switch on the rear-window heating before the engine is running.

The door mirrors have electrically heated glass. Heating is controlled with the same switch as the rear windscreen.



Switches for the AC system

SG 1051



Air conditioning (AC)

The air conditioning system is incorporated in the standard climate-control system and is operated by the same controls. The AC system comes into operation when the button is depressed, provided that the control for the fan is set to any of positions 1 - 4. When the engine is idling, a time-delay relay prevents the AC compressor from cutting in for a second or so, while the engine speed is automatically increased to compensate.

The AC system can be used at outdoor temperatures down to freezing point. If the load on the engine is exceptionally high (throttle butterfly more than 85% open) the AC will cut out until the load on the engine has dropped, whereupon it will be switched on again automatically. The AC system may also be used in cold weather to help keep the windows demisted even when the fan is running at low speed.



Air recirculation

When this switch is depressed, the fresh air intake is closed and the air inside the car recirculated through the ventilation system. This facility is designed for use in hot weather when rapid cooling inside the car is required.

Do not use the air recirculation facility in cold weather as this can result in ice and mist forming on the windows.

Typical settings for different weather conditions



Winter - defroster SG 1052



Winter - cloudy SG 1053



Winter - sunny SG 1054



Summer - cloudy SG 1055



Summer - sunny SG 1056

To obtain maximum heating in very cold weather

When starting the engine from cold, set the fan speed to position 2 and the DISTR control to the defroster position. As soon as the needle on the temperature gauge has started to move up the scale, indicating that the engine is starting to get warm, increase the fan speed by moving the control to position 3. Once the windscreen is clear, move the DISTR control one step to the left.

Obviously the time the engine takes to warm up depends on how the car is driven. It will take longer to heat up at low engine speeds, such as when the car is being driven slowly in a high gear, than at high engine speeds, such as when the car is travelling fast on a motorway. Do not use position 4 on the fan switch, as this is designed for use to blow air into the cabin for maximum cooling in hot weather.

Automatic climate control (ACC) system

This system will maintain the desired temperature inside the car regardless of the ambient temperature. Note that the system will automatically select the settings required to attain the desired temperature as quickly as possible. The car will therefore not heat up or cool down more quickly if you select a higher or lower temperature than that desired.

The temperature shown on the display is not the actual temperature inside the cabin: the system takes into account such factors as air flow, humidity, direct sun, etc. inside the car and then controls the climate to correspond to the perceived comfort expected at the selected temperature.

ACC control panel



SG1286

- The normal range of settings is 19 - 23°C (66 - 73°F), depending on how cool/warm one likes it inside the car, and what type of clothes one is wearing.
- Ideally, changes to the selected temperature should be made in steps of 1°C.
- During the warm-up phase, it is recommended that the middle panel vents be closed, if you do not like warm air being directed onto your face:

Temperatures can be selected within the range 17 - 27°C (63 - 80°F). There are also two other settings: HI (maximum heat and maximum fan speed) and LO (maximum cooling and maximum fan speed).

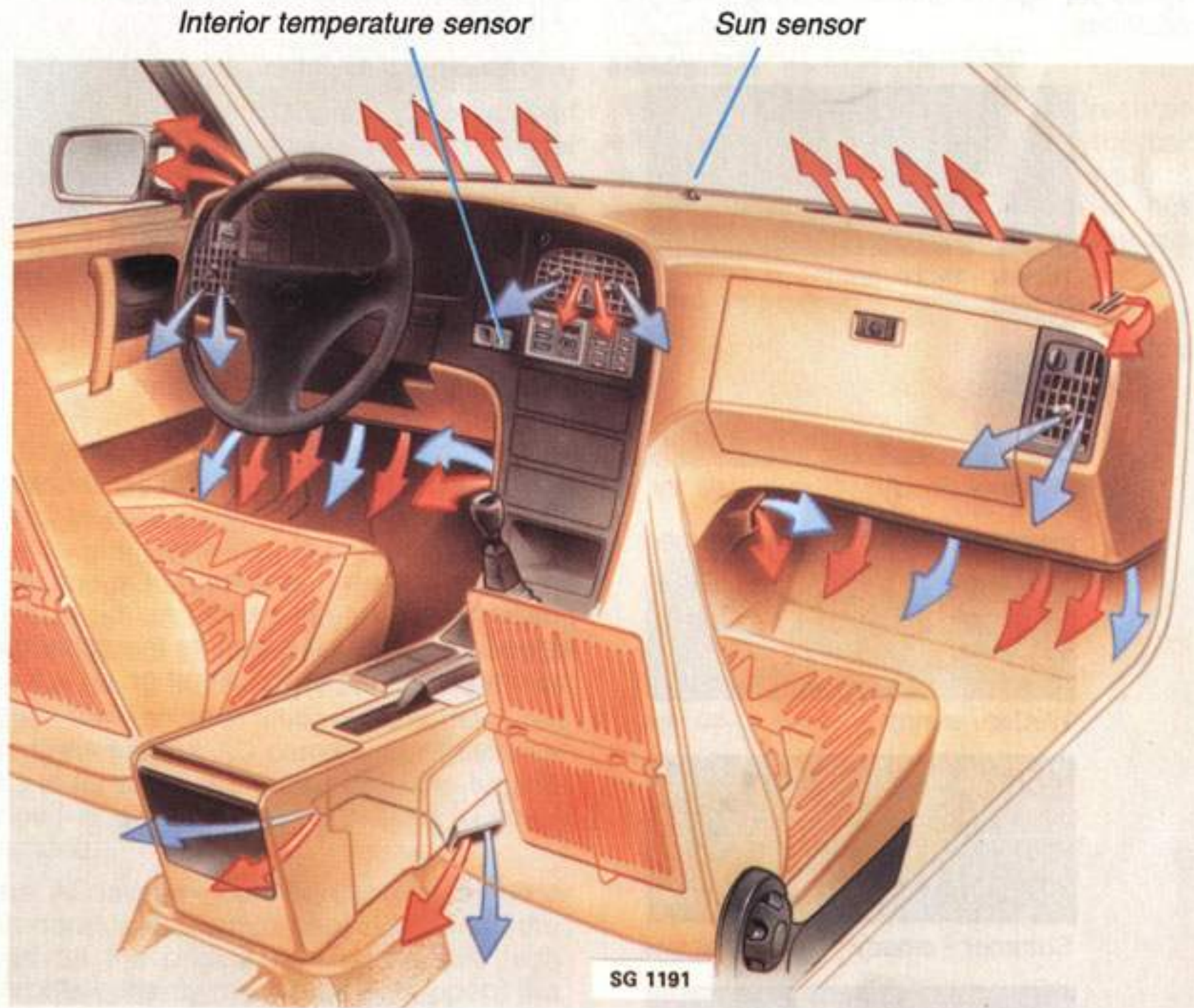

Air vents

- 1 Red arrow = heated air
- 2 Blue arrow = cool air

Rear door fan

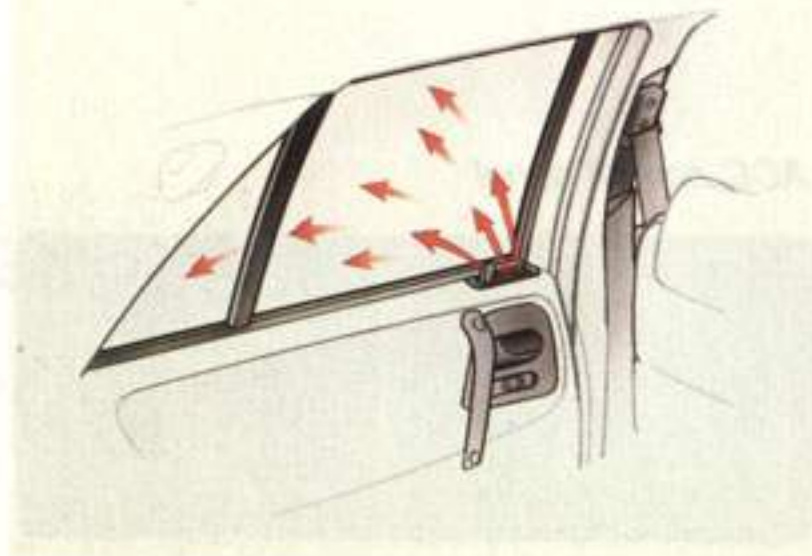

The system has four sensors:

- Ambient air temperature sensor (signal supplied by the EDU trip computer)
- Inside air sensor (located below clock)
- Sun sensor (situated on top of the dash).
- Blended air temperature sensor (in heater unit)

Take care not to obstruct the sun sensor, located midway between the defroster vents on top of the dash, as this can prevent the ACC system from functioning properly.

Sun sensor



SG1057

Starting in cold weather:

Initially the system will automatically select rear-window and door-mirror heating, defroster setting, maximum heat and low fan speed.

To maintain or improve the distribution of cooled or heated air in the car, the system may in certain climatic/driving conditions briefly (max. 30 seconds) direct air to the floor vents.

As soon as the supply air is warm enough, air will be distributed through the floor vents and the fan speed increased. As the cabin temperature approaches the temperature selected, the fan speed and heat supplied will gradually be reduced automatically to a suitable level.

Starting in warm weather:

Initially the system will direct fresh air through the panel vents at a high fan speed and will switch on the AC compressor (unless the ECON button has been depressed).

To maintain or improve the distribution of cooled or heated air in the car, the system may in certain climatic/driving conditions briefly (max. 30 seconds) direct air to the floor vents.

Recirculation will be selected after about one minute if the ambient air temperature is above 27°C. As the cabin temperature starts to approach the selected temperature, the fan speed will be reduced automatically to a suitable level.

Setting the required temperature

- 1 Switch on the ignition.
- 2 Select the desired temperature by means of the appropriate temperature button. The sliding control below the display panel can be used to select either the Celsius or the Fahrenheit scale.
- 3 The selected temperature will now be stored in the microprocessor memory and retained even after the ignition has been switched off. When you next run the car, the microprocessor will automatically set the system to provide the preselected temperature.

Shows the selected cabin temperature



To increase the temperature



To reduce the temperature



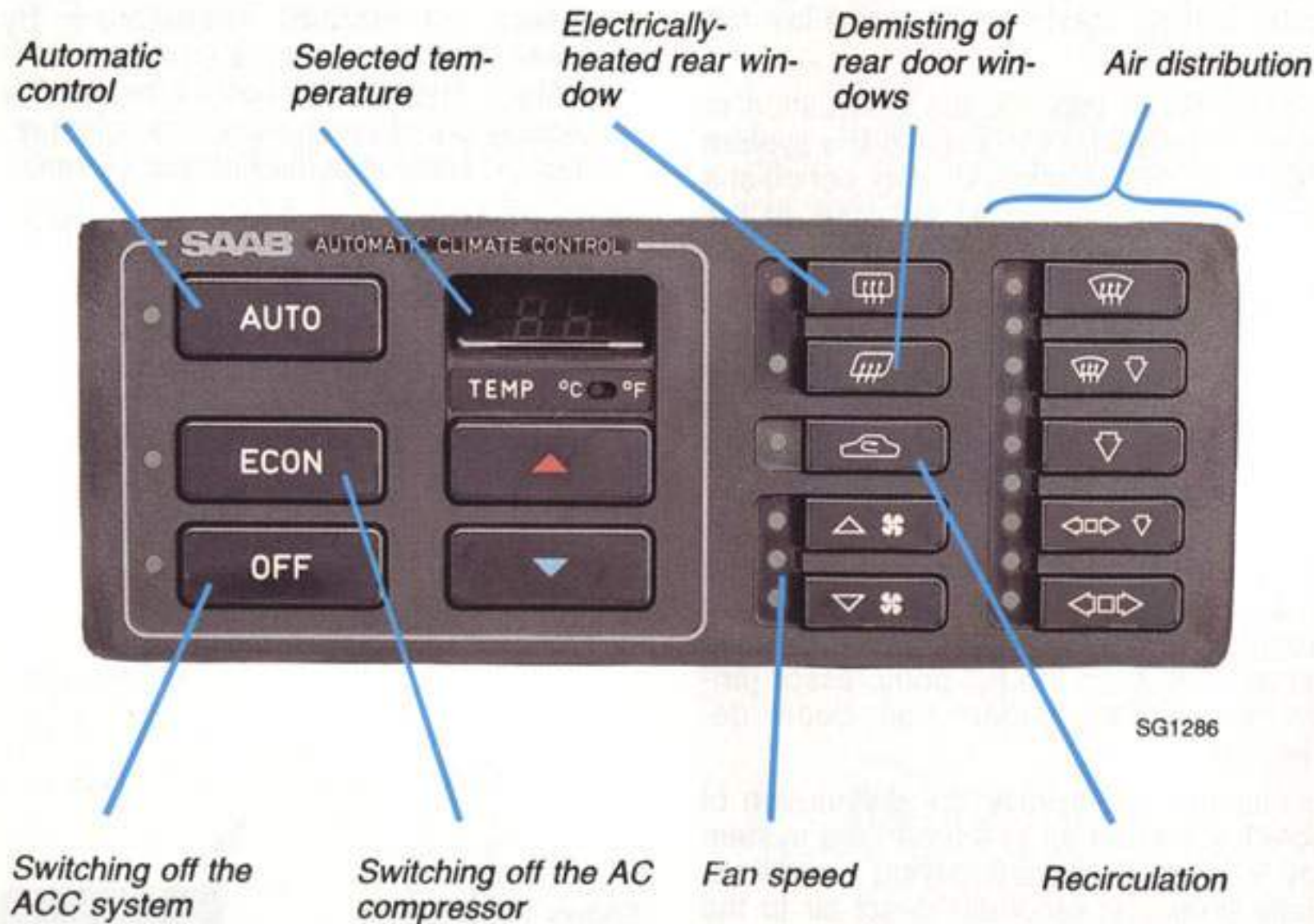

Functions

Although the heating function for the rear window and door mirrors, and the rear-door fans are controlled automatically by the system, it is possible to override the system and switch these functions on or off by means of the appropriate button on the control panel, without affecting the comfort inside the car.

To cancel a function selected manually, press the button again or press AUTO. Once a function has been selected manually, it will remain in the selected mode, but all other functions will remain in the automatic mode. Thus, control of the temperature will always be automatic. LED indicators adjacent to the function buttons indicate which functions are actuated.

AUTO

When this function is actuated, temperature, air distribution, fan speed, heating of the rear window and door mirrors, and air recirculation are controlled automatically. Pressing AUTO cancels all manually selected functions. However, manual selections that have been programmed in will be selected the next time the engine is started (see the section on ACC programming).

ECON

When this function is actuated, the AC unit will not operate. Temperature, air distribution, fan speed and rear-window and door-mirror heating will still be controlled automatically.

OFF

Pressing this button will switch the entire system off. To switch the system on again, press AUTO or OFF again, in which case the last manual selections will be reactivated.



Heating of the rear window and door mirrors is controlled automatically, but can also be switched on manually. In either case, the function will be switched off automatically after 10 or 11 minutes. The function can be turned off manually at any time.



The demister fans in the rear doors are controlled automatically and run at the same speed as the main fan. The fans can also be switched off manually.



Air recirculation is controlled automatically but can also be selected or cancelled manually.

Air recirculation does not change the quality of the air significantly.

To increase the fan speed (stepless variation)



To reduce the fan speed (stepless variation)



Keep the button depressed until the desired fan speed is obtained.

The middle LED indicates that fan speed is controlled automatically, AUTO mode.

The two other LEDs indicate that fan speed has been selected manually:

increase fan speed - top LED lights up
reduce fan speed - bottom LED lights up

Adjusting fan speed from minimum to maximum takes about eight seconds.



Defroster

When defrosting is selected manually, demisting of all windows will be obtained through higher fan speed, maximum air flow from the defroster vents and the vents in the rear doors, and operation of the electrically-heated rear window. Recirculation will be turned off if it has previously been selected.

The defrosting mode remains operative until another mode is selected, although the electrically-heated rear window will be switched off after about 10 minutes.

To return to the setting previously selected, press the defroster button once again.



Defroster/Floor

Air directed through the defroster and front and rear floor vents. A small amount of air will also be directed through the panel vents.



Floor

Maximum flow of air through all floor vents and a small amount of air through the defroster vents.



Floor/panel

Air through the panel vents and front and rear floor vents. A small amount of air will also be directed through the defroster vents.





Panel

Air only to the panel vents. A small amount of air will also be directed through the defroster vents.

Programming the ACC system

It is possible to save the functions selected manually by programming the ACC system. These functions will then be selected automatically each time the ignition is switched on. Note that you must wait at least 4 minutes after switching off the ignition before you can test the programmed functions.

- 1 Select the functions required.
- 2 Press and release  + 

simultaneously (the ACC display and LEDs start flashing).

Cancelling ACC programming



To cancel the programmed settings, press and release OFF + AUTO simultaneously (the display and LEDs start flashing).

Hints and tips:

(before taking the car to an authorized Saab garage)

- If the LED by the AUTO button does not light up: see "Cancelling ACC programming".
- If the ACC system does not work satisfactorily: see "Calibration".
- If the battery has been disconnected or lost its charge, the ACC system will have to be recalibrated.

Calibration

If the power supply to the ACC system has been interrupted (e.g. battery disconnected), the system must be recalibrated. To recalibrate the system, press AUTO + , whereupon the indicator light at the side of  will come on, indicating that calibration and self-testing are in progress. The right-hand array of indicator lights will then also come on, starting at the bottom and working upwards.

During calibration, a '0' will appear on the display or, alternatively, a figure (1 - 5) indicating the number of faults detected. When calibration is complete, the ACC will revert to displaying the selected temperature.

The calibration operation takes about 30 seconds.

Special climatic conditions

Misting and icing on the windows will not normally occur other than in extreme weather conditions, e.g. in heavy rain or cold weather, when humidity is unusually high or the occupants of the car are perspiring heavily or wearing damp clothes.

If misting or ice on the windows is a problem under such conditions, the following action is recommended

- 1 Select AUTO and a temperature of 21°C (70°F).
- 2 Select Defroster. If this is not enough ...
- 3 Increase the fan speed. If this is not enough ...
- 4 Increase the selected temperature



9000 Audio System (option)

The 9000 Audio System has been specially matched to the cabin space in the Saab 9000 models. It has a frequency response of 40 - 16000 Hz measured in the cabin. The system consists of the following components:

- radio and cassette deck with switches and controls for the entire system
- 4 x 32 W amplifier located under the passenger seat
- Front and rear speakers

1 ON/VOL - on/off, volume

The system is switched on and off by pushing the ON/VOL button. When the system is switched on, the last settings are activated. Selected settings are saved when the system is switched off.

Volume adjustment with the ON/VOL button is of the so called endless type, which means that the button can be rotated with no stops. When the system is turned on the volume is the same as when it was turned off.

2 EQ/BAL Bass, treble, balance, fader

Press the EQ/BAL button to select the functions bass, treble, balance (left/right) and



SG1303

fader (front/rear).

Adjust the selected function with the plus/minus button next to EQ/BAL:

Bass	± 6 steps
Treble	± 6 steps
Balance	± 15 steps
Fader	± 15 steps

If no more buttons are pressed, the system automatically returns to normal mode after 5 seconds.

3 EQ/BAL - Loudness

Press the button for at least 2 seconds to engage the Loudness function (louder reproduction of the lower tones).

4 BAND - Waveband selector

Press the BAND button to select the waveband:

(FM1 → FM2 → FM3 → LW/MW).

5 Tuning and seek-tuning

Automatic seek-tuning:

Select sensitivity, LO (strong transmitters) or DX (strong and weak transmitters), by holding the TM button depressed for at least 2 seconds.

Press the button to tune up ▲ or down ▼ the frequency in the waveband selected with the BAND button (LO or DX is shown on the display during automatic seek-tuning). If the RDS and/or TA function (FM only) is engaged, the radio will only seek RDS and/or TA transmitters.

Manual tuning:

To switch to manual tuning, press the TM button. Tune up ▲ or down ▼ to change the frequency.

Manual tuning should start within 5 seconds, after which time the radio returns to automatic seeking.

A short press of the button changes frequency one step up or down. If the button is held down the frequency changes quickly.

6 Quick selection buttons 1-6

Press one of the buttons (1-6) to tune into a preset station.

If the button is held down (at least two seconds) it stores the station currently tuned and the previously set station is erased. The sound disappears during setting.

7 PS/AS- Automatic station memory

When the PS/AS button is held for at least 2 seconds, the radio automatically sets stations. The radio first seeks 6 strong stations. If less than six stations are stored during the first cycle, the radio searches for other stations at higher sensitivity.

If the RDS and/or TA functions are on when automatic station memory is started, the

radio will only store stations with RDS and/or TA function.

The automatic storage of stations also works on the LW/MW band.

8 SOURCE - source selector

Press SOURCE to choose between radio, cassette and CD.

9 RDS - Radio Data System

RDS is an information system transmitted side-by-side with radio programmes on the FM network. Good reception conditions are essential for RDS to work well.

The signal from this type of FM transmitter enables the Audio System to automatically seek the strongest transmitter for the current programme and so maintain good reception irrespective of which transmitter is currently closest.

The RDS function is switched on and off with the RDS button. With RDS on, the display shows which programme you are listening to, for example BBC Radio 1. This is also the case with local radio stations, for example RADIO BRISTOL.

Flashing RDS means that the RDS information signal is too weak. In this case you can press a preset button to seek a stronger signal.

If you start a journey with the radio set to Radio 1, the radio will automatically change Radio 1 transmitter during the journey.

10 RDS - PTY function (Programme TYPe)

This function is based on the fact that programmes on the FM network are coded as to programme type. The PTY function is a sub-function of RDS.

Selection of programme type:

- 1 Press the RDS button for more than 2 seconds (RDS should be activated)
- 2 Using the buttons ▲▼, one can step between the different programme types 1-15. When required selection is reached this is activated after 5 seconds.

The following PTY can be selected:

- 1 - news
- 2 - affairs
- 3 - info
- 4 - sport
- 5 - educate
- 6 - drama
- 7 - culture
- 8 - science
- 9 - varied
- 10 - pop music
- 11 - rock music
- 12 - m.o.r.m.
- 13 - light music
- 14 - classics
- 15 - other music

Survey of display

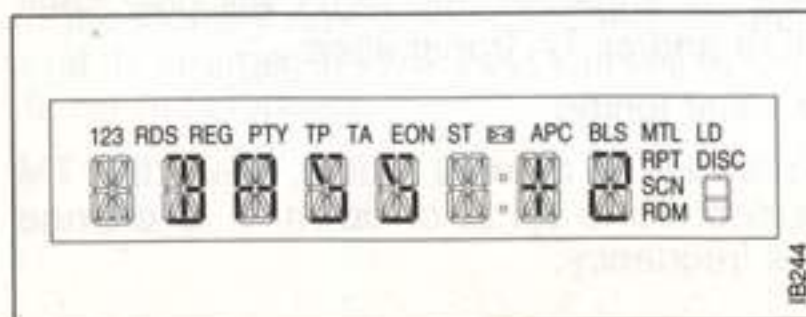

The six preset programme types can also be selected using the quick selection buttons:

- button 1 - news,
- button 2 - info,
- button 3 - pop music,
- button 4 - sport,
- button 5 - classics,
- button 6 - m.o.r.m.
(middle of the road music)

It is also possible to change the preset programme types on the quick selection buttons as follows:

- Hold the RDS button pressed for more than 2 seconds.
- Select programme type using the ▲▼ buttons (5).
- Press desired quick selection button for more than 2 seconds to store the selected type of programme.

When a PTY choice has been made, this type of programme will be received by the radio even if you are listening to another programme source (TAPE, CD or another FM station).

When a programme of a selected type is over, the audio system returns to the previously selected programme source and the radio waits for the next programme of the selected type.

If you want to interrupt the reception of a programme with the selected PTY code,

press the SOURCE button. The radio then waits for the next programme with the selected PTY code.

Changing to another programme type after the PTY function is activated is achieved by pressing the RDS button for more than 2 seconds.

You then make a new selection using the quick selection buttons or the ▲▼ buttons.

If a cassette or CD is playing when you choose a programme type, this recording will continue to play until the selected programme type is transmitted.

Cassette or CD playback will then be interrupted while the selected programme type is being transmitted. You can change between CD, TAPE and RADIO without affecting the PTY selection (do not select LW/MW as no RDS functions work on this waveband).

The PTY function is switched off by pressing the RDS button.

After the PTY function has been switched off the RDS button functions to switch the RDS function on and off.

11 TA - Traffic Announcement (traffic reports)

By activating the TA function with a press on the TA button, you enable any traffic reports to interrupt cassette/CD playback.

This function is independent of the RDS function. When a traffic report is transmitted, radio reception or cassette/CD play-

back is interrupted. The display shows "TRA INFO" and the volume is adjusted to a preset level (if the preset volume is lower than the one you have yourself selected for playback, the volume remains unchanged). When the traffic report is over, playback resumes with previous settings.

TP - Traffic Programme

TP indicated on the display shows that the current transmitter can relay traffic messages.

If the current transmitter cannot relay traffic messages (no TP indicated on the display but TA function activated) an automatic search starts for a transmitter with TP transmission.

EON - Enhanced Other Network (updating of other transmitter nets)

Updating of other transmitter nets is automatic provided the EON indicator is on (you cannot activate EON yourself).

If you are listening to Radio 1 during a journey, the Radio 3 frequencies will also be updated, even if you are not listening to Radio 3.

EON makes it possible to receive traffic messages and PTY signals sent over a transmission net you are not listening to.

Alarm interruption

With RDS activated, a programme source can be interrupted for important messages

30 Instruments and controls

other than traffic information. In this case the display shows ALARM.

12 TA - REG (REGional)

If you want the radio only to receive a pre-set local radio station, you can activate the REG function by holding the TA button pressed for more than 2 seconds (REG appears on display).

The REG function is switched off by holding the TA button depressed for more than 2 seconds (REG disappears from the display).

When the REG function is switched off and you activate the preset button where the local radio station is stored, the radio searches for another local radio transmitter (PI SEEK). If the preset button is again pressed, the radio searches for the next nearest local radio transmitter.

Quick Guide - Radio

Function	Button	Press	Sequence
Band selection	BAND	< 2 s	→ FM1 → FM2 → FM3 → LW/MW →
Sensitivity	T.M.	> 2 s	→ DX → LO →
Frequency setting	T.M.	< 2 s	→ AUTO → MAN →
Up the band	△		→ 87,0 → 108,0 →
Down the band	▽		→ 108,0 → 87,0 →
Sound profile	EQ AM	< 2 s	→ BAS → TREB → BAL → FAD →
Loudness	EQ AM	> 2 s	→ LOUDNESS → ON → OFF →
Scan pre-set	PS AS	< 2 s	→ FM1 → FM2 → FM3 →
Auto store	PS AS	> 2 s	FM3
RDS	RDS PTY	< 2 s	→ RDS ON → RDS OFF →
PTY	RDS PTY	> 2 s	→ RDS ON → PTY ON → PTY OFF →
TA	TA REG	< 2 s	→ TA ON → TA OFF →
REG	TA REG	> 2 s	→ RDS ON → REG ON → REG OFF →

Cassette player

Carefully insert a cassette into the aperture with the open side to the right. Radio and CD playback is interrupted and the system goes over to cassette playback.

Make sure that any labels on the cassette are not loose and that the cassette is not bent as this can cause the cassette to become jammed in the player.

During playback the display shows TAPE>> or TAPE<<, depending on which side of the cassette is being played.

1 Cassette changeover

Cassette is manually changed over by pressing the BAND ◀ ▶ button.

The cassette is automatically changed over when one of the ends is reached during fast forward or playback. Playback of the other side of the tape begins.

2 Fast Forward, Rewind and Music Search

Press the FWD button to fast forward or the REW button to rewind

If one of these buttons is pressed during fast forward or rewind, music search starts (APC appears on the display). Fast forward or rewind stops at the next piece, provided that this is preceded by a silent section of at least 4 seconds.

Fast forward and rewind, with or without music search, can be stopped by pressing



SG1303

the BAND button ◀ ▶.

Music search may not function properly in the following circumstances. This does not however mean that there is any fault.

- Tapes with gaps of less than 4 seconds between the different recordings. These are too short for the system to detect.
- Tapes with conversation where there are pauses of at least 4 seconds. The system interprets these as gaps in the tape.
- Recordings with very low level for at least 4 seconds. The system interprets these as gaps in the recording.

3 Cassette Eject button

Stop playback by pressing this button or by selecting another programme source (RADIO/CD) using the SOURCE button. When another programme source is selected the cassette remains in the player

and the sound head and the pinch rollers are lifted from the tape. This also happens if the radio is switched off during cassette playback. The eject also works when the radio is turned off.

4 SCN - 10 second playback of every track

Engage the function by pressing the SCN button (SCN shows on the display). Select FWD or REW (fast forward or rewind starts). Pressing FWD or REW one more time starts a 10 second playback of every track. You can switch between FWD and REW while SCAN is running.

5 BLS - (BLank Skip)

When the BLS button is pressed during normal playback a forward music search starts (FF-APC appears on display) if the tape has a silent section of approx. 12 seconds.

Playback resumes when the player finds a recorded section.

6 Dolby[®], noise reduction

Dolby B is activated with the button
Cassettes recorded using Dolby should be played back with the Dolby function on.

7 RPT - (RePeaT) - Track repeat

Press the RPT button to repeat the track being played. RPT shows on the display.

When the player is rewinding to repeat the track, REPEAT shows on the display.

Metal tapes

The cassette player has an automatic metal tape switch.

Cassette care

Do not expose cassettes to direct sunlight or very high or low temperatures as this can damage the cassette and the tape.

Always keep cassettes in the box when not in use.

Take the cassette out of the machine when not in use.

If a cassette jams in the machine, contact an authorized Saab workshop.

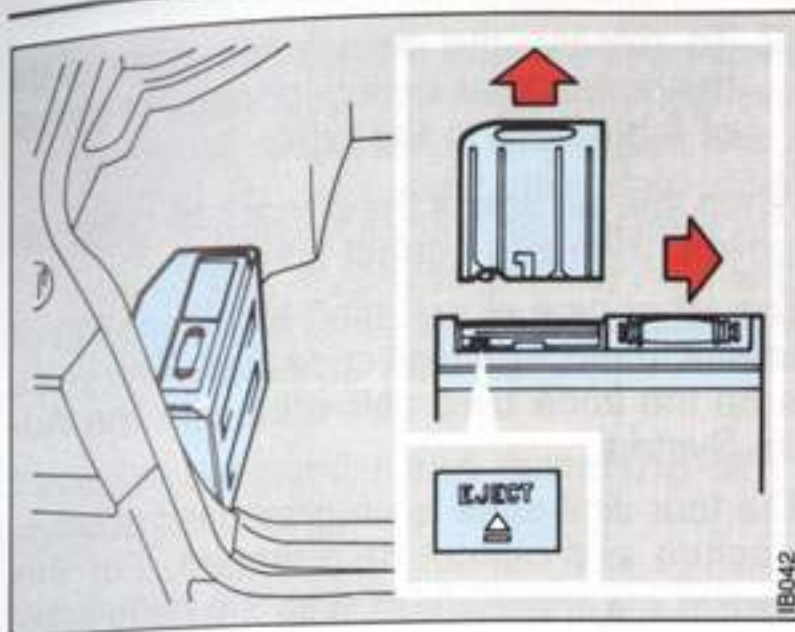

CD-changer in the boot

CD Changer

Load the CD changer in the boot (1-6 discs) as follows:

- 1 Slide away the protective cover over the disc magazine.
- 2 Push EJECT and remove the magazine.
- 3 Insert the discs in the magazine slots (text up).
- 4 Load the magazine into the CD changer and slide back the protective cover.

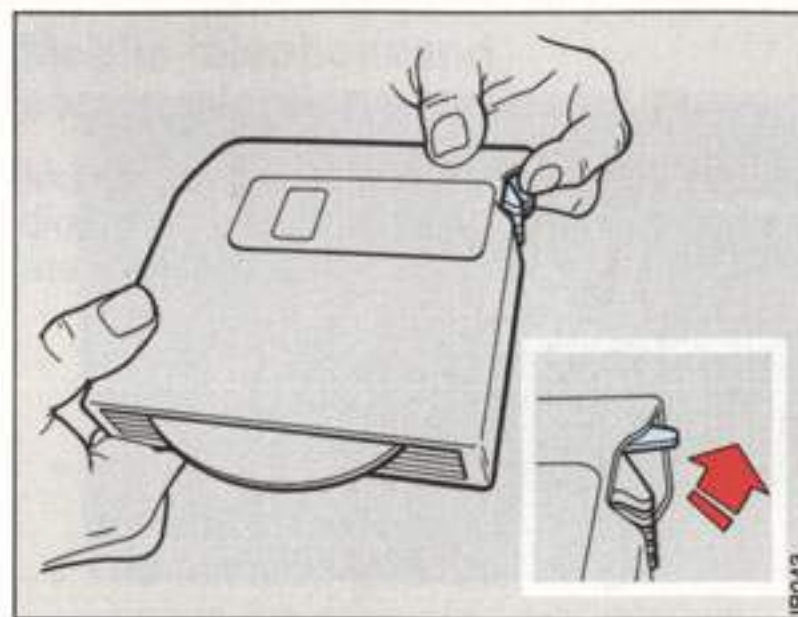

When changing discs in the magazine, release already loaded discs by pressing in the locking arm. There is one locking arm for every disc slot.

Playing CD's

When a CD magazine has been loaded in the CD changer, playback will start at the first track of the first CD when CD is selected with the SOURCE button.

If CD is selected when the changer is empty, NO PACK shows on the display.

If the cassette player or radio is activated during CD playback, the CD player goes over to pause mode.

If CD playback is reselected with the SOURCE button, playback continues where it stopped.

1 DISC

Disc change is achieved with the DISC button. If a disc slot is empty or if there is a fault with a disc the next disc in the magazine is activated.

2 FWD/REW

Pushing FWD (forward) makes the recording jump to the next track.

Pushing the REW button (reverse) makes the current track replay from the beginning.

If either button is held down for more than 2 seconds, the disc is played fast forwards or backwards. This function continues for 5 seconds after the button is released. If the button is held for more than 5 seconds, fast playback is even faster.

Pressing one of these buttons when the CD changer is in RDM mode makes the player skip the current track. The RDM function remains.

3 RDM - (RanDoM) - Random playback

The RDM function is activated by pressing the RDM button. This starts random playback of one disc at a time.

When all tracks on this disc have been played, random playback continues with the remaining discs in order. This function is switched off by pressing the RDM button again. The RDM function is also switched off when the SCAN button is pressed.

If FWD or REW is pressed during random

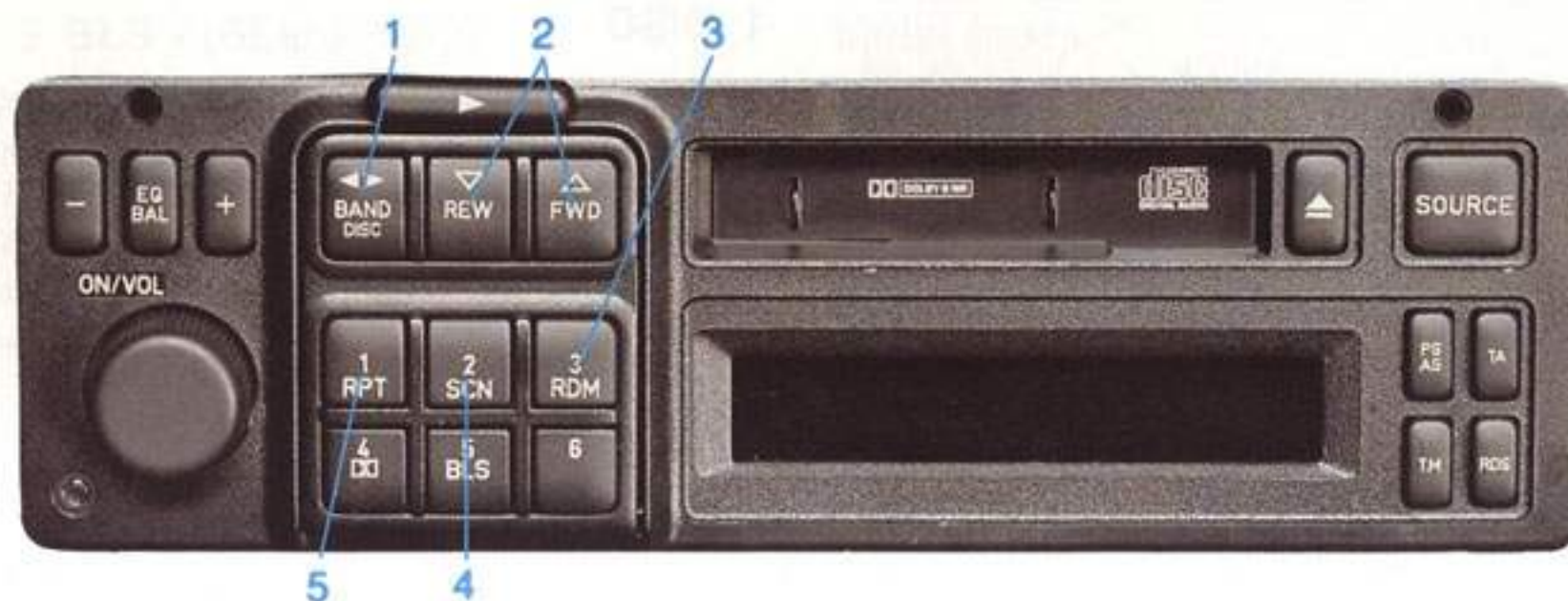

playback, the CD player jumps to the next track and random playback continues.

Stop CD playback by choosing another programme source (RADIO/TAPE).

The CD player then goes over to pause mode.

4 SCN - 10 second playback of every track.

This function holds through the entire disc magazine. If the SCN button is pressed while the SCAN function is running, the CD player goes over to normal playback of the current track.

The SCAN function can also be cancelled by pressing one of the following buttons: FWD/REW, RDM, DISC, SOURCE, or if the radio is switched off.

5 RPT - (RePeaT) - To repeat a track or a whole disc

Press the RPT button to select the repeat of either one track (REPEAT TRACK is displayed) or a whole disc (REPEAT DISC is displayed). RPT is shown on the display when the function is activated.

Anti-theft lock

The Audio System is equipped with two types of anti-theft lock.

One type is that a section of the radio panel containing 9 buttons (quick selection buttons etc) is detachable:

- 1 Switch off the audio system.

- 2 To release the detachable part, slide the rectangular switch (above the group of 9 buttons) to the right.

When this section of the panel has been removed, the radio cannot be used.

The other type of anti-theft lock consists of an electronic, four digit code lock. The code is on the code card delivered with the Audio System.

The four digit code is programmed at manufacture and cannot be changed. For this reason it is important to keep the code safe, but never with the unit. If code should be lost, contact an authorized Saab dealer to gain access to the code.

If the battery is disconnected, if the system is dismantled or for some reason disconnected, the four digit code must be entered using the quick selection buttons as follows:

- 1 Turn on the radio (display shows CODE IN)
- 2 Enter the four digit code using the quick selection buttons and the radio starts. If an incorrect digit has been pressed, a total of four digits must be pressed to make a new try possible. After all four figures have been pressed, hold the BAND button depressed for more than three seconds to clear the display. The display now shows CODE IN again and the correct code can be entered.

- 3 If the wrong code is entered three times in a row, wait an hour with the unit switched on before trying again. After waiting for one hour, the right code must be given on the first attempt otherwise you must wait another hour with the unit switched on before making a further attempt.

Telephone controlled lowering of volume

If a mobile telephone is installed in the car it can be wired so that the Audio System's volume is lowered when the telephone is used. Contact your Saab agent.

Adjusting the preset volume of traffic messages

The preset volume level can be adjusted if desired as follows:

- 1 Hold the TA button depressed as the radio is switched on (display shows VOL ADJUST).
- 2 Adjust volume.
- 3 Press any other button or wait 5 seconds to lock the volume at the new level.

Mobile telephone and communications radio

Mobile telephones and communications radios **without** separate outside aerials radiate an electromagnetic field in the cabin.

WARNING

- The radiated field in the cabin can be dangerous to health
- The radiated field can cause interference in the car's electrical system

For this reason Saab recommends that you always attach your telephone / communications radio to an **external aerial**.

An external aerial also improves transmission, reception and range.

For traffic safety reasons always stop your car in a suitable place when calling.

Mobile telephones and communications radios which are not part of Saab's standard equipment can interfere with the car's electronics system and give spurious warnings.

WARNING

- Always contact an authorized Saab workshop for fitting instructions.
- If you suspect an unclear fault warning/indication contact an authorized Saab workshop for checks.

Technical data

Tone controls

Bass	±10 dB at 100 Hz
Treble	±10 dB at 10 000 Hz

Power output

4 x 32 W
(1 % THD 1 kHz)

Radio unit

Radio system

PLL synthesized
tuner, RDS receiver

Frequency range

FM	87.5 MHz – 108 MHz
MW	531 kHz – 1602 kHz
LW	153 kHz – 279 kHz

Scanning steps

Automatic scanning	FM 100 kHz MW 9 kHz LW 3 kHz
Manual scanning	FM 50 kHz MW 9 kHz LW 1 kHz

Cassette player

Fast forward/rewind	< 130 sec (C-60)
Frequency response	50 Hz – 12,500 Hz ± 3 dB
Wow and flutter	0.1 % WRMS
Stereo separation	> 30 dB
Signal-to-noise ratio	> 45 dB
Dolby NR	> 53 dB

CD changer

1 bit "Bit Stream" 8 times oversampling	
Number of discs	6 pcs.
Frequency range	5-20,000 Hz
Dynamics	95 dB (1 kHz)

- Specifications comply with EIA Interim Standard
- For reasons of improvement we reserve the right to change specifications and appearance without prior notice
- Dolby noise reduction is manufactured under license from Dolby Laboratories Licensing Corporation
- "DOLBY" and the double D symbol  are trade marks of the Dolby Laboratories Licensing Corporation



Interior equipment

Seats	38
Steering-wheel adjustment . .	40
Seat belts	40
Airbag	42
Child safety	45
Rear-view mirrors	46
Electric windows	47
Sunroof	48
Ashtrays	49
Audio equipment	49

Seats

On some markets the electric heating of the seat and backrest cushions of the front seats is individually adjustable and can be operated by means of the switch when the ignition switch is in the drive position.

The front seats can be adjusted for legroom, the rake angle of the backrests has stepless adjustment and the head restraints can be raised or lowered. Apart from being adjustable for height, the driver's seat also has an adjustable lumbar support.

The front of the driver's seat can be raised and lowered (both front seats on certain model variants).

Head restraints

The front-seat head restraints can be raised or lowered to one of several preset positions.

WARNING

The car must be stationary during adjustment of the driver's seat.

When the car is being driven, the backrest should be in an upright position to ensure that the seat belt, airbag and backrest will provide the best possible protection during heavy braking or in the event of a collision.

To adjust the head restraint

For best protection, the head restraint should be level with the occupant's head.

To raise the head restraint: grip it on either side and pull it straight up.

To lower the head restraint: press the top straight down.

Legroom adjustment

Lift the bar and slide the seat to the desired position. Release the bar and check that the seat is locked in the new position.

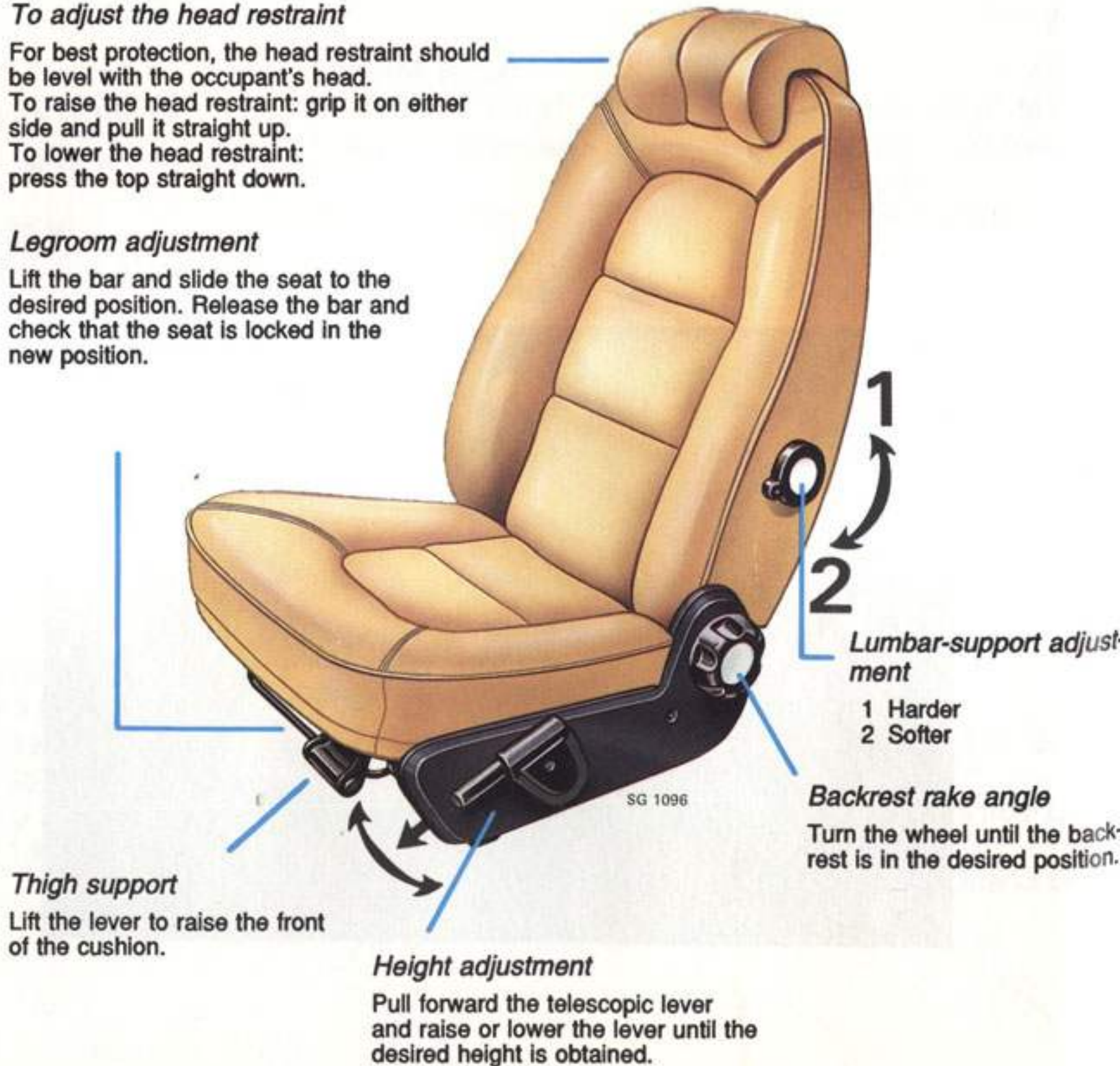

Thigh support

Lift the lever to raise the front of the cushion.

Height adjustment

Pull forward the telescopic lever and raise or lower the lever until the desired height is obtained.

Lumbar-support adjustment

- 1 Harder
- 2 Softer

Backrest rake angle

Turn the wheel until the backrest is in the desired position.

Electrically adjustable front seats

Electrically adjustable front seats are available as an optional extra.

The top control is for adjustment of the backrest.

The lower control is for legroom adjustment and for individual height adjustment of the front (thigh support) and back of the seat.

The seats incorporate a safety feature enabling them to be operated with the ignition switched off if the door is open. If the door is closed, however, the ignition must be switched on.

This feature makes it easier to enter the car and also minimizes the danger of injury to

Controls for electrically adjustable front seats

- 1 Backrest rake angle
- 2 Legroom and height adjustment
- 3 Memory functions



SG1115

children who happen to be playing with the seat.

In the event of an electrical fault, a special winder included in the tool kit can be used to adjust the seat manually for legroom. From underneath at the back of the seat, insert the winder in the electric motor (the one on the right-hand side, nearest to the back of the seat).

Turn the crank clockwise to move the seat rearwards and counter-clockwise to move the seat forward.

Location of crank

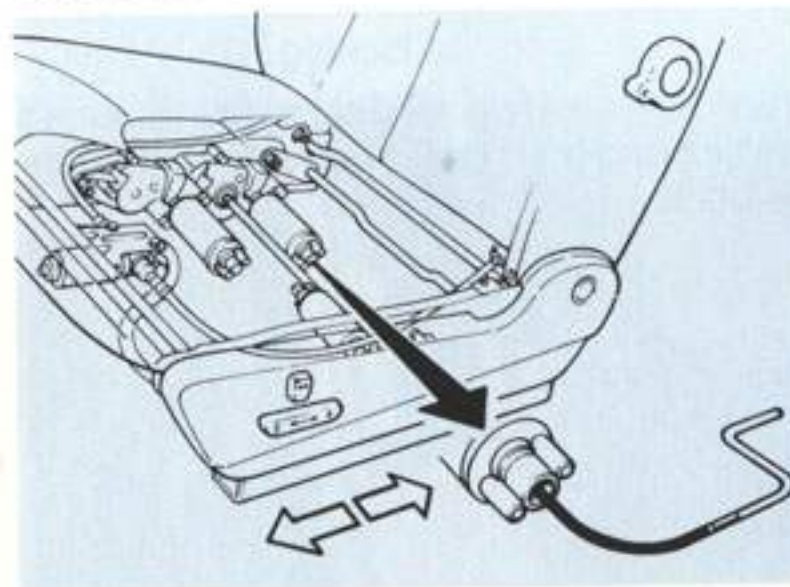

SG1014

Electrically adjustable front seats with memory

As an option, electrically adjustable front seats can be provided with a memory function.

After the seat has been adjusted by means of the ordinary controls, the seat setting can be stored in the memory by simultaneously pressing the memory (M) button and one of the position buttons 1, 2 or 3.

To activate the memory function, keep the required position button depressed while the seat is assuming its stored setting. If one of the three stored settings is to be altered, re-adjust the seat by means of the ordinary controls, and then depress simultaneously the M button and the required position button.

The seats incorporate a safety feature enabling them to be operated by means of the setting or memory buttons with the ignition switched off if the door is open. If the door is closed, however, the ignition must be switched on. This feature makes it easier to enter the car and also minimizes the danger of injury to children who happen to be playing with the seat.



Electrically heated driver's and co-driver's seats

The car has adjustable electric heating of both the driver's and the co-driver's seat cushion and backrest. The heat output can be adjusted individually for each seat in three steps. In position 3, the heat output is a maximum, whereas in position 0, the heating is switched off.



Locking handle for the steering wheel^{SG1287}

Steering-wheel adjustment

Fore-and-aft adjustment of the steering wheel is possible after the handle has been turned to release the locking mechanism.

Move the steering wheel to the required position and then lock it by turning the handle back.

Seat-heating controls



SG 636

Seat belts

Seat belts should be worn at all times. Research has established that it is equally dangerous for rear-seat passengers not to wear seat belts. In the event of a collision, unrestrained rear-seat passengers are thrown violently forward against the front-seat backrests. This doubles the force put on the front-seat occupants and seat belts, frequently resulting in injury to all the occupants. Each belt may only be worn by one person at a time.

Front seat belt



SG 383

⚠ WARNING

- Seat belts are designed to bear upon the bony structure of the body, and should be worn low across the front of the pelvis, or the pelvis, chest and shoulders, as applicable: wearing the lap section of the belt across the abdominal area must be avoided.
- Seat belts should be adjusted as firmly as possible, consistent with comfort, to provide the protection for which they have been designed. A slack belt will greatly reduce the protection afforded to the wearer.
- Care should be taken to avoid contamination of the webbing with polishes, oils and chemicals, and particularly battery acid. Cleaning may safely be carried out using mild soap and water. The

Correct placement of seat belt

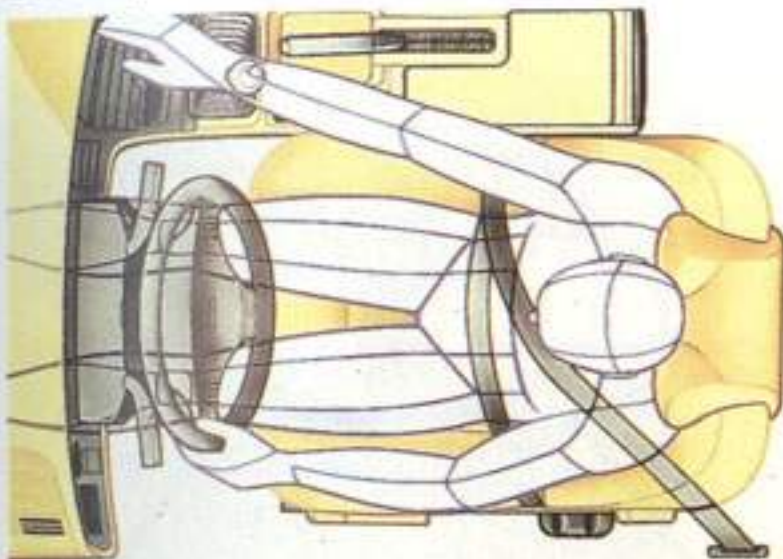

SG 955

belt should be replaced if webbing becomes frayed, contaminated or damaged.

- It is essential to replace the entire assembly after it has been worn in a severe impact even if damage to the assembly is not obvious.
- Belts should not be worn with straps twisted.
- Each belt assembly must only be used by one occupant; it is dangerous to put a belt around a child being carried on the occupant's lap.
- No modifications or additions should be made by the user which either prevent the seat belt adjusting devices from operating to remove slack, or prevent the seat belt assembly from being adjusted to remove slack.

Belt guide on door pillar



SG 639

Apart from the belt for the middle rear-seat passenger, the seat belts are of the inertia reel type. To fasten a seat belt, pull the strap gently out of the reel and insert the tongue in the lock. Make sure that the tongue is properly secured. The bottom anchorage points for the front seat belts are fitted to the seats and therefore move with the seat when the legroom is being adjusted.

The seat belts for the front seats are equipped with an automatic belt pretensioner.

These seat-belt pretensioners are always activated in a severe head-on collision but are not triggered by lighter frontal collisions. They restrict the forward movement of the wearer in a collision.

Rear-end and side collisions do not activate the pretensioners, nor are they activated if the car rolls over.

⚠ WARNING

Seat belts, seat-belt pretensioners and other constituent parts must be inspected after every collision. Saab recommends replacing all component parts of the seat belts in use during a collision. No replacement is required after a minor collision if an authorized Saab garage finds that no damage has occurred and judges everything to be in proper working order.

Seat belts and components that were not in use during the collision must also be

inspected and replaced if they show signs of damage or faulty operation.

If the airbag system has been activated, both front seat-belts must be changed.

The height of the belt guide on the door pillar is adjustable. It is normally set in the upper position. This setting provides the greatest protection. On short persons, the diagonal strap may run too close to the neck. The belt guide can then be lowered until the strap runs across the body somewhat below the neck, to maintain the same level of protection. To alter the height of the guide, squeeze the sliding piece as indicated by the arrows and move it to the desired position. Make sure that the guide is securely locked in the new position.

For maximum protection, the seat belt should be worn with the hip strap low across the hips and the diagonal strap well in on the shoulder but not too close to the neck. Make sure that the belt is not twisted or rubbing against any sharp edges and that there is no unnecessary slack in the straps.

Do not recline the backrest by too great an amount as the seat belt is designed to provide protection when the seat is adjusted to an ordinary seating position.

To release the buckle, press the red button marked PRESS.

Most of the time when the belt is being worn the reel will not be locked, thus allowing freedom of movement. However, the reel



Lengthening the lap strap

SG 385

will lock if the strap is jerked or withdrawn sharply, if the car is tilted at a steep angle, or if the car is braked hard or is involved in a collision. A seat belt warning light on the overhead panel will show if either of the front seat occupants has neglected to fasten his belt.

The belt for the middle rear-seat passenger is of the lap-belt type and can be adjusted manually. If required, lengthen the belt before fastening it by holding the adjuster at right angles to the strap and pulling the strap out. Tighten the belt by pulling the free end until the belt fits snugly against the body. To release the belt, press the red button on the buckle.

Pregnant women

Expectant mothers should take care to fit the belt such that it does not apply pressure

to the abdomen. The hip strap should be as low as possible across the hips.

WARNING

Make sure that the belts do not become trapped when the rear-seat cushion is tipped forward or folded back.

Airbag (SRS system)

Driver's seat

The car's SRS (Supplementary Restraint System) consists of an airbag incorporated in the steering wheel. On some variants, an

Driver's and passenger's airbag inflated

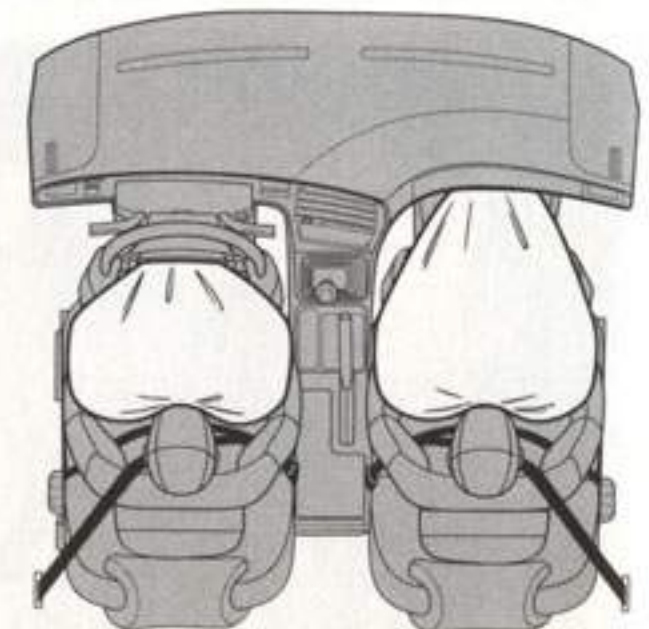

The airbag during front-end collision

Start of collision



The sensor has registered the decrease in speed and sends a signal to a gas generator, via the control module, which inflates the airbag.



The airbag reaches the driver.



The airbag is completely inflated.



The steering column is crushed and the airbag starts to empty.



airbag is also fitted on the front passenger's side.

The system is fitted as a complement to the seat belts and provides additional safety in the event of a collision. An SRS warning lamp in the pictogram lights up or flashes if a fault arises in the Supplementary Restraint System, see page 8.

The driver's seat should always be adjusted so that the warning lamp is not obscured by the steering wheel.

When the system is activated at the instant of a collision, the airbag incorporated in the steering wheel is inflated. The airbag will be inflated in the event of a severe frontal collision but will not be activated by a minor head-on, rear-end or side collision or by the car rolling over.

⚠ WARNING

- Even though the car is equipped with a Supplementary Restraint System, seat belts must be worn by all the occupants.
- Note that since the airbag inflates and deflates extremely rapidly, it affords no protection in the event of a second collision occurring during the same accident.
- When driving, you should adopt a position with your entire back resting against the seat backrest and not sit hunched over the steering wheel. Otherwise, if the airbag is activated, you

could be thrown forcibly against the backrest and sustain injury.

- Never attach any objects to the steering wheel as they could injure your face when the airbag is inflated.
- The gas that fills the airbag when it is set off is very hot. In certain circumstances the hot gas may cause burns on the arms as the airbag empties.

⚠ WARNING

If the warning lamp starts flashing or fails to go out when the car is being driven, the car should be taken immediately to an authorized Saab garage for checking. If the SRS warning lamp lights up or starts flashing, it could mean that the system would not be activated in the event of a collision.

The system should be checked in accordance with the service programme.

Front passenger airbag

As an option, the car can be equipped with an airbag for the front-seat passenger. The system is of the same type as fitted for the driver. It is connected to and monitored by the same SRS warning lamp. The front passenger airbag is located behind a cover on the dash. Both systems will be activated during a collision.

⚠ WARNING

- Child seats should **always** be fitted to the rear seat. Otherwise the child could be injured by the airbag in a collision.
- Children should not stand in front of the front passenger seat as they could be seriously injured by the airbag in a collision.
- Do not place any objects on the dash or in front of the seat as they could injure the car occupants in a collision or interfere with the operation of the airbag. Also make sure that no accessories are mounted on the instrument panel.

⚠ WARNING

No modifications affecting the steering wheel or the electrical system should be made to cars fitted with a Supplementary Restraint System. Both battery cables and the SRS electronic unit must be disconnected before any welding work is commenced. Following this, wait at least 20 minutes before starting on the actual work. The electronic unit must be removed from the car before quick-drying after painting.

Airbags and seat-belt pretensioners must be activated before the car is scrapped or when system components are removed for scrapping. Airbags and seat-belt pretensioners that have been activated in a collision must be replaced.

Work involving the replacement or scrapping of airbags or seat-belt pretensioners must be carried out by an authorized Saab garage.

Check the system as laid out in the Service Programme.

Common questions about the airbag

Do you need to use a seatbelt in cars equipped with an airbag?

Yes. The airbag is only a compliment to the car's ordinary safety system. An airbag is only activated by heavy front-on collisions.

It does not give any protection during minor collisions, side-on collisions, rear-end collisions or rollovers.

The seatbelt prevents the occupants of the car being thrown against each other and sustaining injury.

During a front-on collision, the seat belt also helps you meet the airbag in the right way, that is to say directly forward. If you hit the airbag at an angle, it provides much less protection.

Does the detonation of the explosive charge make a loud noise?

The detonation makes a short loud noise. Most people who have experienced this do not remember the noise of the explosion, but rather the noise from the actual collision.

Can one use a child seat in the front seat if the car has an airbag in the passenger position?

No. The airbag is filled with such power and speed that the child seat would be thrown violently backwards, causing the child to incur serious injury.

Is the dust released dangerous?

Most people who have been in the car with bad or no ventilation for several minutes get only slight eye or throat irritation.

People who suffer from asthma may have an attack and should act as recommended by their doctor. They should then seek medical advice.

Child safety

Safety of children in the car is just as important as that of adults.

For maximum safety when travelling in the car, children should be restrained in some way. The form of restraint used must be suitable to the size of the child. Before fitting any kind of safety seat, harness, booster cushion, etc., you should first consult your Saab dealer.

Be sure you are familiar with the law and other regulations dealing with the fitting of child seats and how children should be seated in the car.

Child seats available from your Saab dealer have been approved by Saab Automobile AB and require no other anchorage than the car's regular lap-diagonal seat

mounting lugs are provided under the passenger seat for other child seats require anchorage points under the

⚠ WARNING

- Children should always be restrained in some way when travelling in the car.
- In cars equipped with an airbag on the front passenger's side, no child seat of any type **should** be fitted to the passenger seat. In the event of a collision the child could be injured by the airbag. For this reason, the passenger seat has no mounting lugs or colour markings for a child seat.
- Child seats fitted to the front passenger seat in cars not equipped with an airbag on the passenger's side must not be secured to the legroom adjustment control. In an accident, the seat may move and have a detrimental effect on the anchorage of the child restraint.

Mounting lugs for a child seat with underneath anchorage straps.
NOTE! Mounting lugs at the front are not fitted in cars equipped with an airbag on the passenger's side

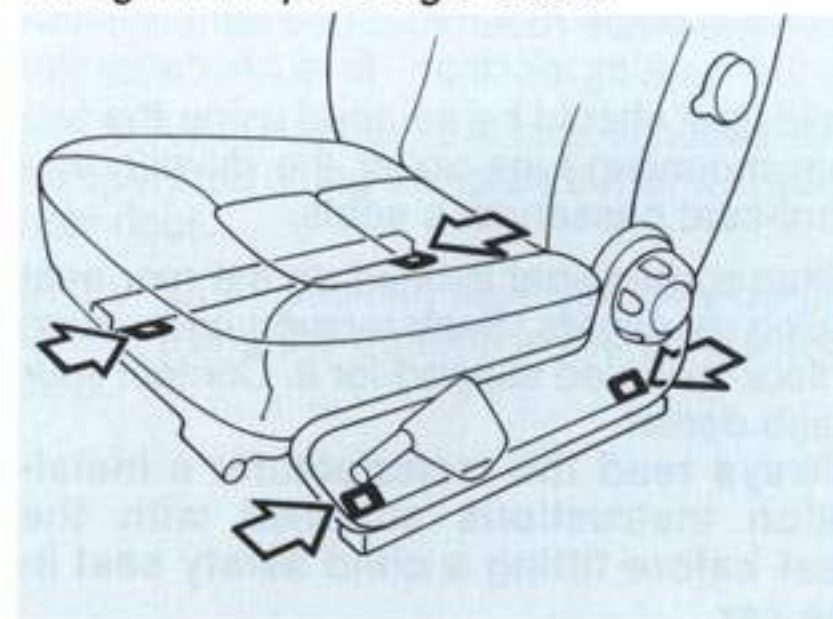

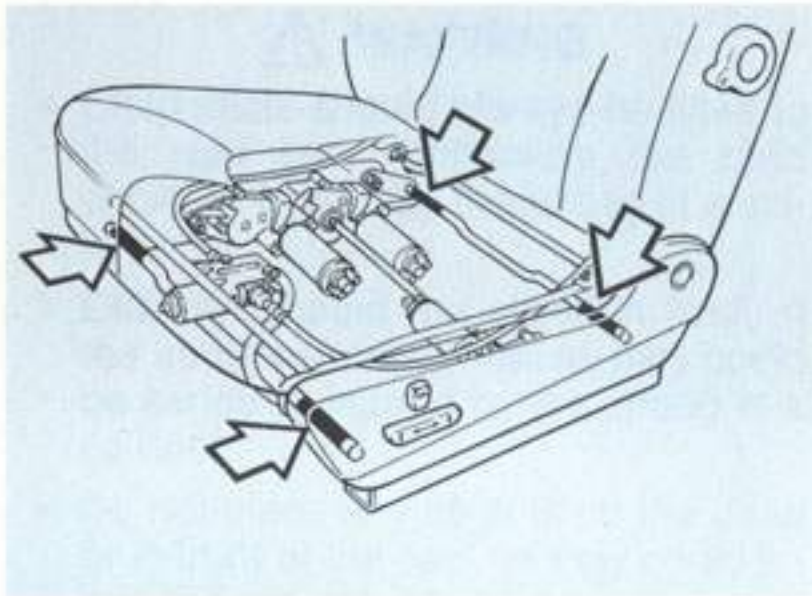

*Child seat mounting lugs
(electrically adjustable front seat)
NOTE! There are no front colour
markings on cars equipped with an
airbag for front passenger*

SG1255

For a child seat which is approved for rearward-facing installation on the rear seat, the place recommended for it is in the centre seating position. In such case, the child seat should be secured using the two rear mounting lugs under the driver's and front-seat passenger's seats.

When a child seat is fitted on the rear seat facing rearwards, Saab recommends using a floor-mounted support for it. Contact your Saab dealer.

Always read the manufacturer's installation instructions supplied with the seat before fitting a child safety seat in the car.

In cars with electrically adjustable front seats there are four light-blue colour

markings on the seat frame where child safety seats are to be anchored.

⚠ WARNING

- When a child safety seat designed for children weighing more than 10 kg is fitted facing rearwards on the passenger seat, make sure that the backrest of the child seat rests against the instrument panel. Carefully follow the installation instructions supplied with the child safety seat.
- When a child safety seat designed for children weighing 0-10 kg is fitted on the front passenger seat, it should be fitted so that its backrest is at least 20 cm away from the instrument panel.
- It is just as important to ensure that the straps on the child seat are properly tightened. They must on no account be left slack. The child seat should be fitted as securely as possible to provide optimum protection for the child.

Saab child safety seats

Your Saab dealer stocks specially-adapted child safety seats for your car. They are approved by Saab Automobile AB and designed to provide the same degree of protection in the car as for adults. They are also comfortable and easy to use.

The child safety seat is available in three different versions, depending on the weight of the child: 0-10 kg, 9-18 kg and 15-36 kg.



Rear-view mirror

SG 386

Rear-view mirrors

The rear-view mirror is of the anti-dazzle type and can be deflected by means of the lever underneath the mirror.

The door mirrors are anti-glare treated and the one on the driver's side is of the wide-angle type.



Catch for door mirror

SG 388

If subjected to excessive force, the mirrors will fold back. The mirrors can also be parked in this position. Carefully fold the mirror backwards until it engages the catch. To release the mirror, press it back and push in the catch.



Door mirror switches

SG 387

The control for the door mirrors is located on the driver door.

The front switch for adjusting the mirrors can be moved in four directions. The rear switch is used to select the mirror to be adjusted.

The door mirrors are electrically heated. They are connected using the switch for the heated rear windscreen.

Electric windows

Opening:

Press the window symbol on the button.

The button has a second position for automatic opening. When the button is pressed beyond the first position, the window opens completely.

Automatic opening can be interrupted by quickly lifting the symbol side of the button.

Closing:

Lift the symbol side of the button.

Closing stops when the window is completely closed or when the button is released.

Child-proofing, rear electric windows (ON/OFF)

Using the ON/OFF button you can choose if the rear windows can be operated with the extra buttons in the rear doors.

In the "ON" position, the rear windows can be operated using the extra buttons in each rear door.

In the "OFF" position they can only be operated using the buttons in the centre console.

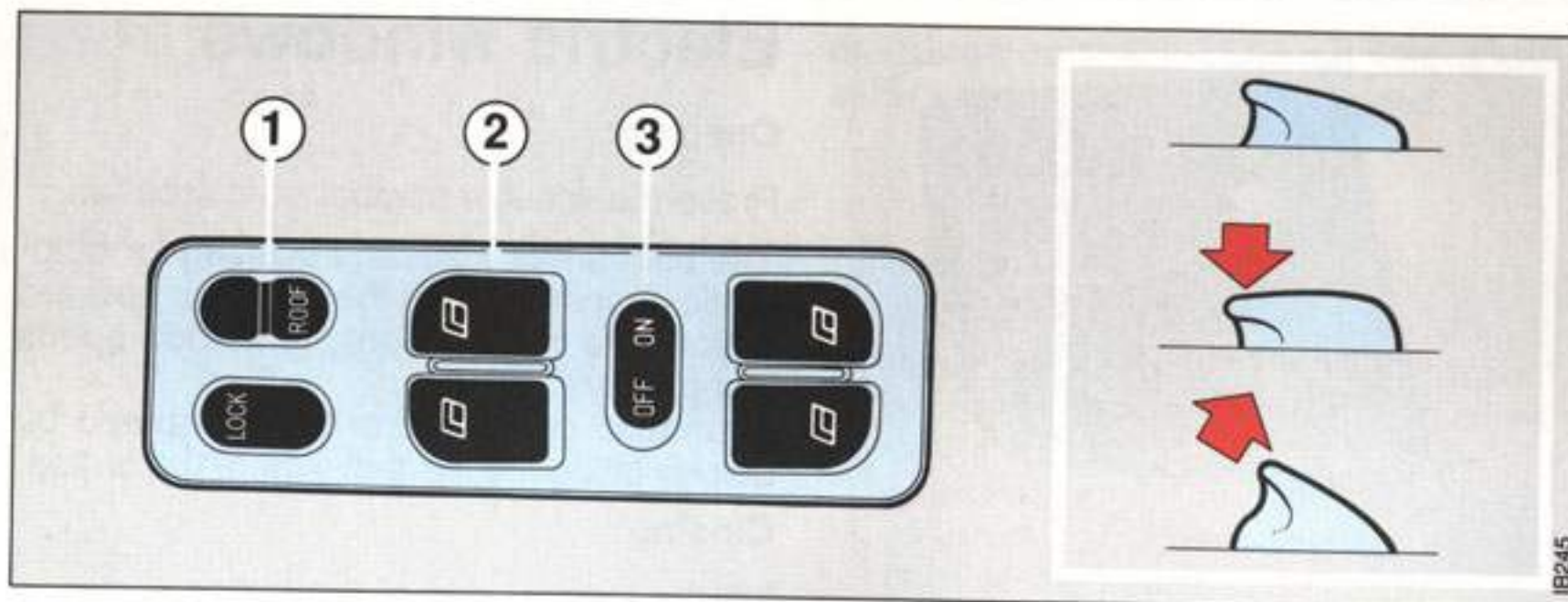

Switches, centre console

- 1 Control, sunroof
- 2 Control, electric windows
- 3 Control for switching off electric windows in rear doors

Door switches are also provided for operation of the rear windows, but these can be rendered inoperative by a switch on the centre console (marked ON/OFF) to prevent children playing with them.

WARNING

Always remove the ignition key when leaving the car to avert the risk of injury arising from unattended children operating the windows.

Sunroof

The sunroof is operated by the ROOF switch on the centre console. The sunroof can be opened fully or partially. As soon as the switch is released, the sunroof is locked in position.

- 1 To open the sunroof from the completely closed position, do as follows:
 - To open - push the switch back
 - To close - push the switch forwards
- 2 It is also possible to open the rear edge of the sunroof from the closed position (ventilation position):



SG1023

Manual operation of sunroof

- To open - push the switch forwards
- To close - push the switch back

You must however release the switch between each position to change between the two functions.

There is also a manually retractable sunshade over the glass sunroof.

When the sunroof has reached its end position, it can be opened a few centimetres further by pressing the button again. But the button will then have to be pressed twice to close the sunroof.

A manual winder for emergency operation of the sunroof (e.g. in the event of an electrical fault) is stored inside the cover on the overhead switch panel. Insert the short end of the crank into the hexagonal hole. Turn counter-clockwise to close the sunroof.



Illuminated make-up mirrors

SG1288

Illuminated make-up mirrors

Some models are equipped with illuminated make-up mirrors on the rear of the sun visors. The light comes on when the mirror cover is lifted. The sun visor must be fitted in both its brackets.

Ashtrays

The car is fitted with two ashtrays: one in the fascia and one at the back of the centre console between the front seats.

The front ashtray is incorporated in the modular radio console. This system allows the owner to choose his own arrangement of the ashtray, radio, etc. in the three compartments.

To remove the front ashtray from its hous-

ing, first depress the catch and then withdraw the ashtray.

To remove the rear ashtray, make sure it is fully open and then press down and pull it forward.

To refit the ashtray, engage the two springs in the corresponding lugs, press down on the ashtray and push it back in.

Audio equipment

Cables for the radio, aerial and speakers have already been run in the car. The cables are accessible behind the radio console, the speaker grilles on the fascia and the trim on both sides of the luggage compartment.

Mobile telephones and communications radio equipment used without a separate out-

Front ashtray



SG1228



Rear ashtray

SG 393

side aerial emit radio waves which are reflected inside the cabin.

WARNING

- The field of electromagnetic radiation inside the cabin may be injurious to health
- The field of electromagnetic radiation can give rise to interference in the car's electrical system

Saab therefore recommends that you always connect your mobile telephone and/or communications radio equipment to an external aerial.

An external aerial will also improve transmitting and receiving conditions as well as giving your equipment a longer range.

From the viewpoint of road safety, it is advisable to stop the car at a suitable place before telephoning.



Doors, locks and luggage compartment

Doors and locks	52
Luggage compartment	53
Glove compartment	57
Bonnet	57
Emergency opening of fuel filler cap	58
Anti-theft alarm.	58

Doors and locks

The central locking system is operated by the locks in both front doors. The central locking system locks and unlocks doors and fuel filler cap.

The central locking system can also be operated from inside the car by means of a switch on the centre console. However, it cannot be operated by the locking buttons on the doors, which only lock and unlock their own door.

If you want to leave the car with the doors open, they should still be closed by such an amount that the courtesy lighting goes out. This will avoid running the battery flat.

Driver's door lock

- 1 To lock
- 2 To unlock

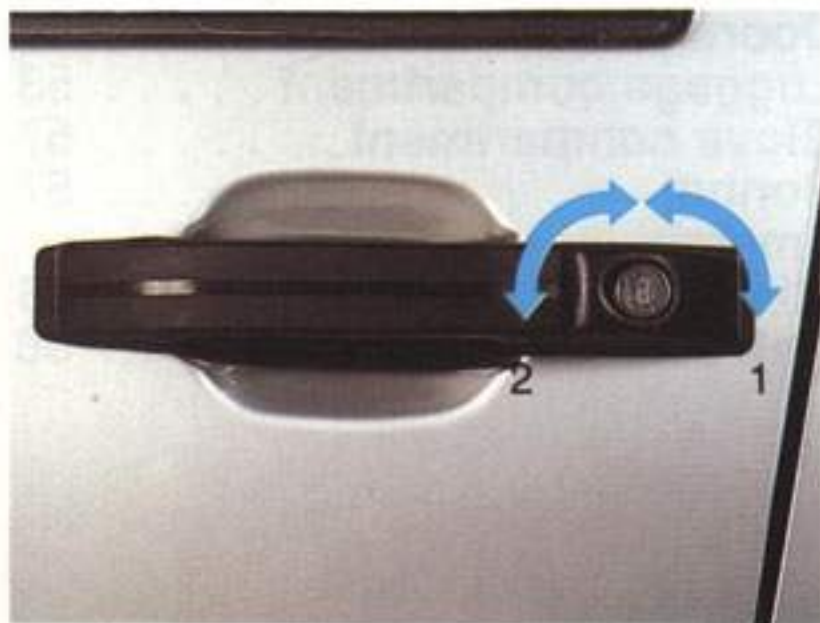

SG 638

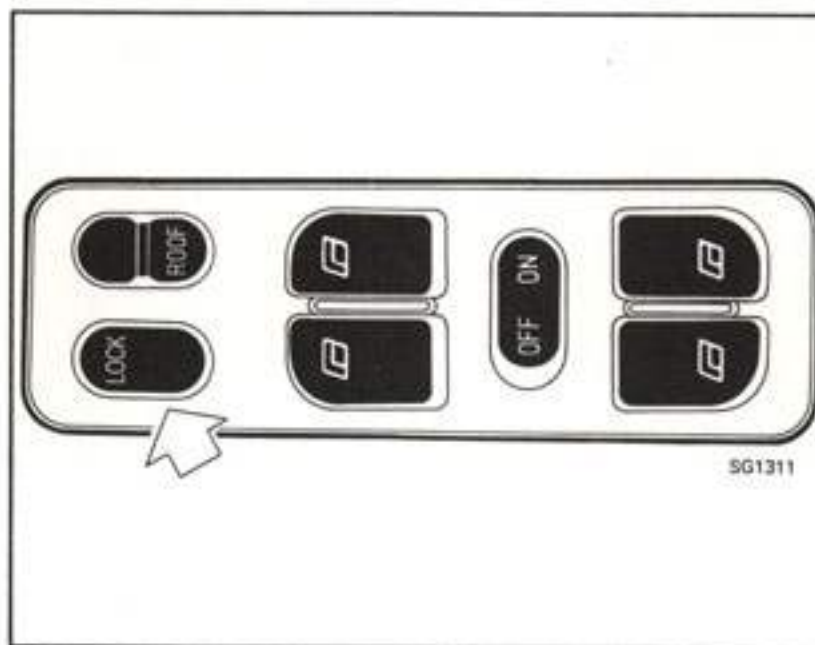

Central locking switch

Child safety lock

- 1 Engaged
- 2 Disengaged

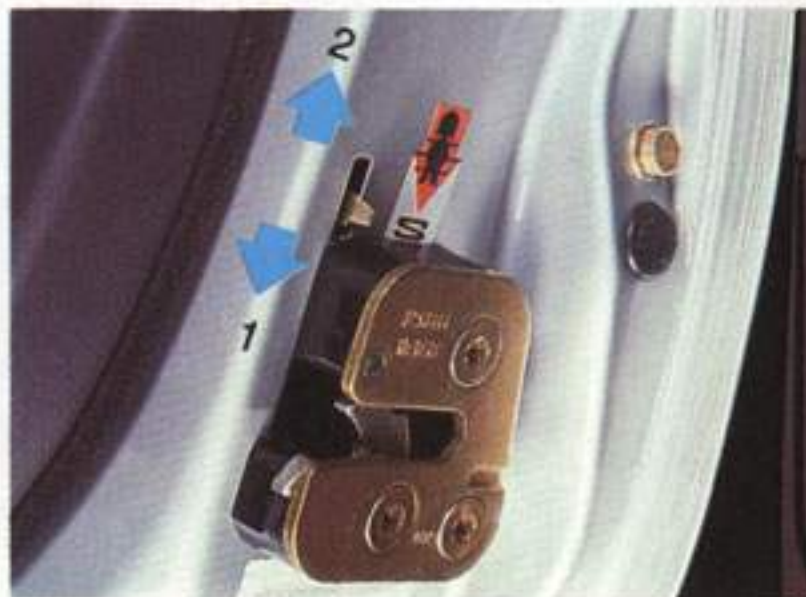

SG 770

If you want to leave the doors wide open, remove the fuses for the interior lighting and electrically adjustable seats (fuse Nos. 16, 25 and 26).

The rear doors are fitted with child safety locks which are engaged and disengaged by a catch incorporated in the door lock. When the child safety lock is engaged, the door can be opened only from the outside.

WARNING!

Always keep the door locked when the car is in motion. Locked doors can reduce the risk of:

- passengers, particularly children, opening the door and falling out of the car.
- intruders getting in when the car is slowing down or stationary
- injuries due to a door opening in the event of an accident.

To prevent injuries occurring due to careless or inadvertent operation of electrically adjustable seats, never leave children alone in the car.



Switch for luggage compartment door SG1024

Luggage compartment door (9000 CS)



SG1177

Luggage compartment

9000 CS

⚠ WARNING

Never place heavy objects on the parcel shelf as they could be thrown forwards and cause injury to the car occupants if the car is braked suddenly or involved in a collision.

The tailgate is not included in the central locking system. Unlock it by means of the switch on the driver's door or with the key. It is always locked when closed.

The parcel shelf is split into two sections. The rear section can be folded up to facilitate loading. The parcel shelf should be re-

Removing the head restraint



SG1021



Stowing the head restraint after removal

SG1022

moved when the backrest and seat cushion are folded forward. Otherwise, in the event of a collision, it might be thrown forward and cause injury. The parcel shelf can also be removed completely by lifting the rear section to free the pins from the holes and sliding the shelf out through the luggage compartment door.

To increase the cargo space, the rear seat may be folded forward.

Note that the head restraint must be removed before the backrest is folded forward. Release the catch and lift off the head restraint. Hang the head restraint on the pin in the top anchorage for the backrest.

With the narrower section folded forward, two people can occupy the rear seat and long narrow objects can be carried in the luggage compartment.

With the wider section folded forward, there



Straps for seat cushions

SG 402

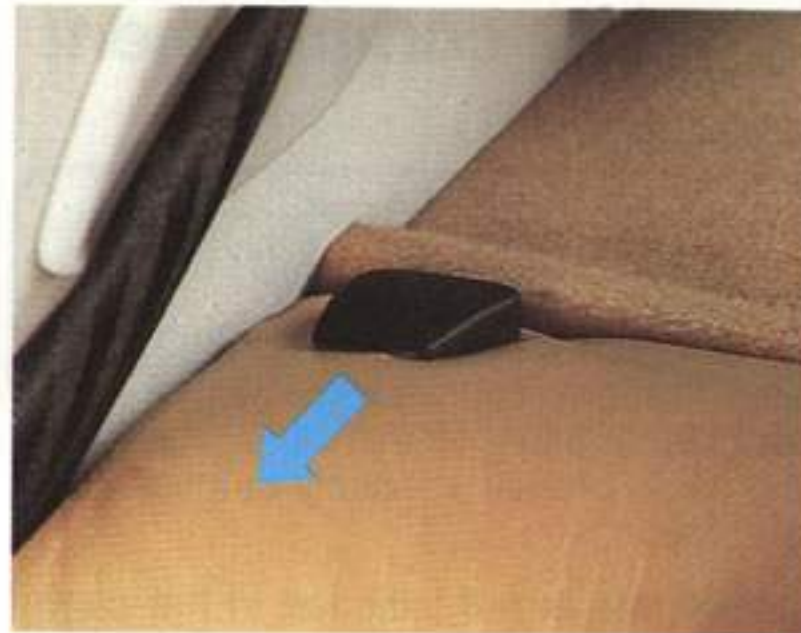

Backrest catch

SG 403



Catch for backrest folded forward

SG 461

is room for one rear-seat passenger and long, wider items of cargo.

To release the seat-cushion catch, pull the strap between the cushion and backrest forward and upwards. Tip the cushion forward so that it stands on edge behind the front seats.

Release the backrest catch and fold the backrest forward. Press the backrest down so that the clip clears the top of it and secure the backrest. It is also important to press the backrest down when folding the clip back.

9000 Aero: When the rear seat is folded forwards, Aero specification cars have a somewhat smaller luggage compartment capacity than cars with standard fittings.

IMPORTANT

If the car is equipped with the special Aero fittings, take extra care when folding the rear-seat backrest forwards. Do not press it forcibly down as this could damage the side supports. Also avoid placing heavy objects on the folded backrest.

Lugs for securing load

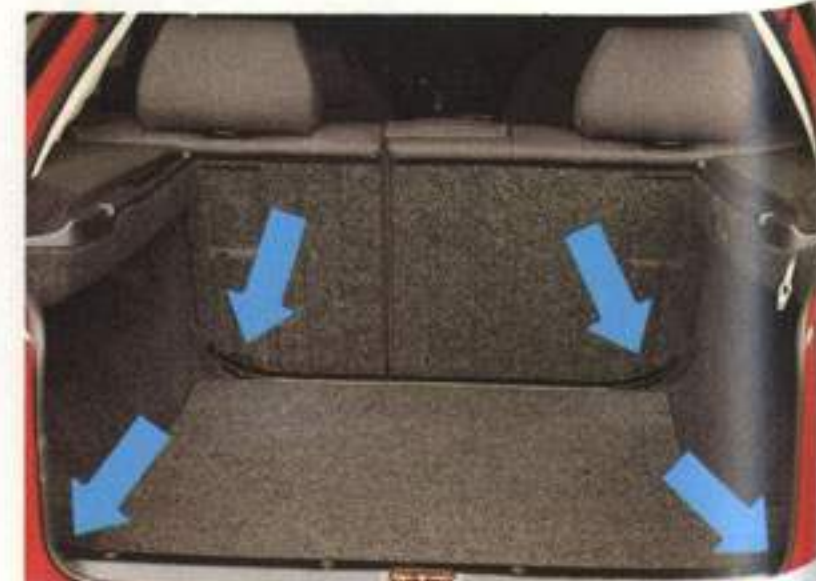

SG1226

⚠ WARNING

Lay heavy luggage flat on the floor. Then place smaller lighter cases on top.

Whenever carrying a heavy or bulky load in the luggage compartment, always secure it to the four lugs provided for this purpose.

This reduces the risk of luggage being thrown forward in the event of sudden braking or a collision.

In order to maintain the car's normal driving characteristics, its maximum load capacity must not be exceeded, see page 107

Make sure that the seat and backrest cushions are locked in position when they have been folded back.

Boot, 9000 CD

⚠ WARNING

Do not place heavy objects on the parcel shelf. If the car is braked suddenly they could be thrown forwards and cause injury to the car occupants.

The boot-lid lock is not included in the central locking system. Unlock it by means of the switch on the driver's door or with the key. It is always locked when closed.



Switch for boot lid lock

SG1108



Pushbutton for hatch

SG 802

The rear seat backrest does not fold forwards but a hatch is provided in the middle of the backrest so that long narrow objects can be carried.

Before opening this hatch from inside the boot, fold the armrest down and lower the fabric partition which is fastened at the top by a velcro closure.

Boot-lid lock

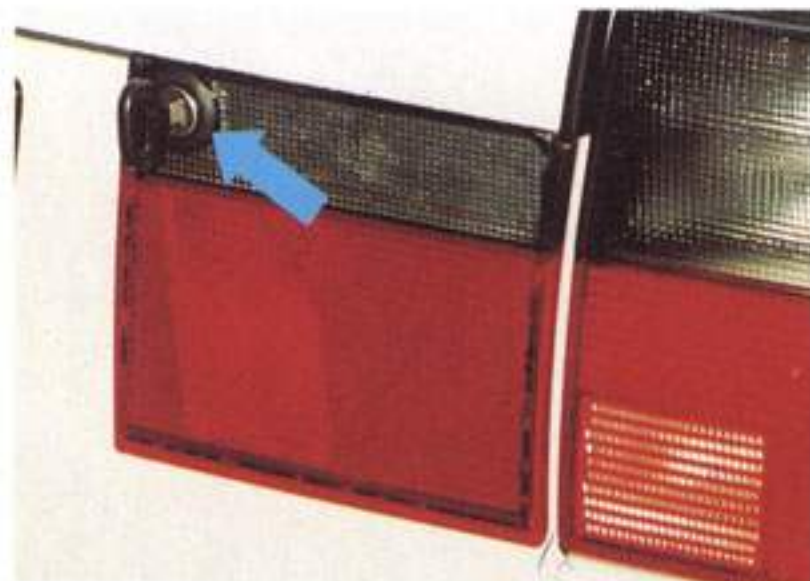

SG1289



Securing the cargo

SG 828

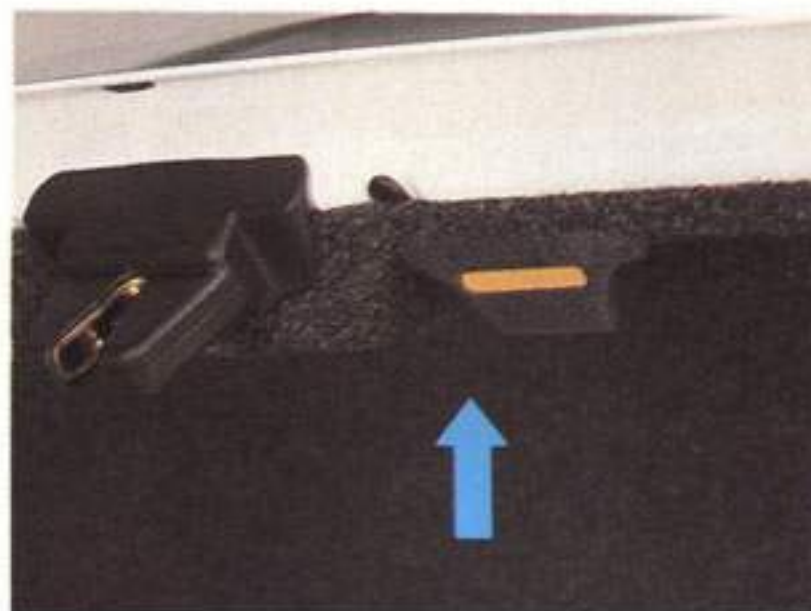

Closing handle

SG1105

⚠ WARNING

Use the lap belt in the middle of the seat to secure the load to prevent it shooting forward, in the event of sudden braking or a collision.

In order to maintain the car's normal driving characteristics, its maximum load capacity must not be exceeded, see page 107

Before loading or unloading long items, switch off the engine and apply the handbrake. This avoids the danger of the load pushing the gear/selector lever into gear, causing the car to start moving.

All models

The spare wheel, jack and jack handle, and warning triangle are stored under a panel in the luggage compartment floor. The hinged panel may be secured in the upright position by means of a rubber loop under the right-hand side of the parcel shelf.

The tool box is stowed away at the right-hand side of the luggage compartment and can be easily removed for use outside the car.

Tool box



SG1290

Glove compartment



SG 395

Glove compartment (cars without airbag on the passenger side)

- 1 To unlock
- 2 To lock
- 3 To open the glove compartment

WARNING

The glove box should be kept closed when the car is in motion as it may otherwise cause injury to the legs in a collision.

Bonnet

The bonnet release handle is located on the left-hand side, underneath the instrument panel.

To open the bonnet:

- 1 Pull the handle.
- 2 The leading edge of the bonnet will then spring up, providing access to the safety catch.
- 3 Push the catch upwards and lift the bonnet.

To close the bonnet, release it from a height of about 20 cm (8 in). **Do not** push down on the bonnet.



Bonnet release handle

SG 405

Bonnet catch

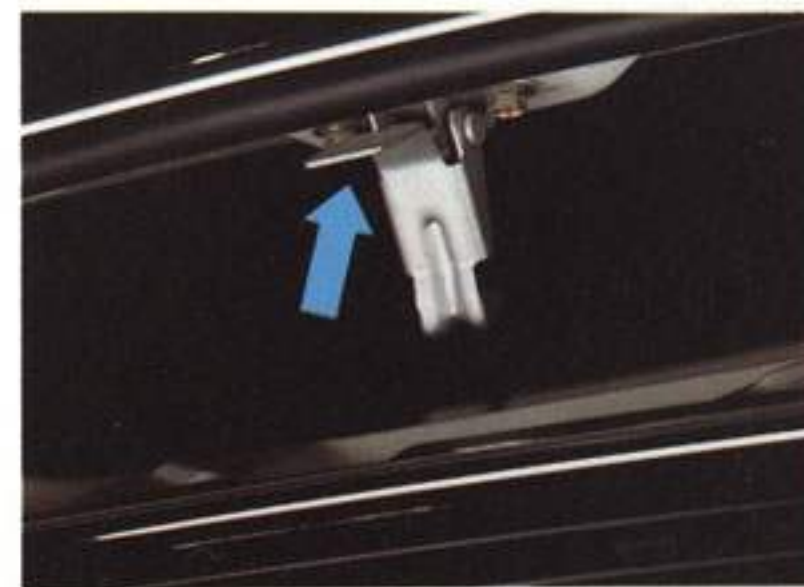

SG1203

Emergency opening of fuel-filler flap

If the central locking system should fail to release the fuel-filler flap, first check fuse 16. If the fuse is intact or a new fuse also blows, the flap will have to be unlocked manually.

Behind the tool kit on the right-hand side of the luggage compartment is a cord which is attached to the locking bar of the fuel filler cap flap. Pull this cord until it stops. The filler cap flap can then be opened.



Remote control for Anti-theft alarm SG1291

- 1 Button for activating/deactivating alarm
- 2 Button for unlocking the boot

Anti-theft alarm

Some models have a factory-installed anti-theft alarm.

The anti-theft alarm is activated / deactivated using a remote control.

When the anti-theft alarm has been set off, the car cannot be started as the starter motor, the fuel pump and the engine management system are disconnected.

All doors as well as the bonnet and boot are monitored with micro-switches and a glass sensor trips the alarm if any of the windows are broken.

When the car is locked using the remote control, activation of the anti-theft alarm is delayed for 10 seconds. During this time, doors, bonnet and boot lid can be opened without tripping the alarm.

The light-emitting diode is lit throughout this 10 second delay after which it flashes every other second while the alarm is activated.

Note that the delay time does not start until after the delayed interior light has gone out (approx. 15 seconds).

If any door, the bonnet or the boot lid is open or if there is any electrical fault when the central lock is activated with the remote control, the light-emitting diode flashes once a second for 10 seconds to indicate that something is wrong.

Cord for emergency opening of fuel filler flap

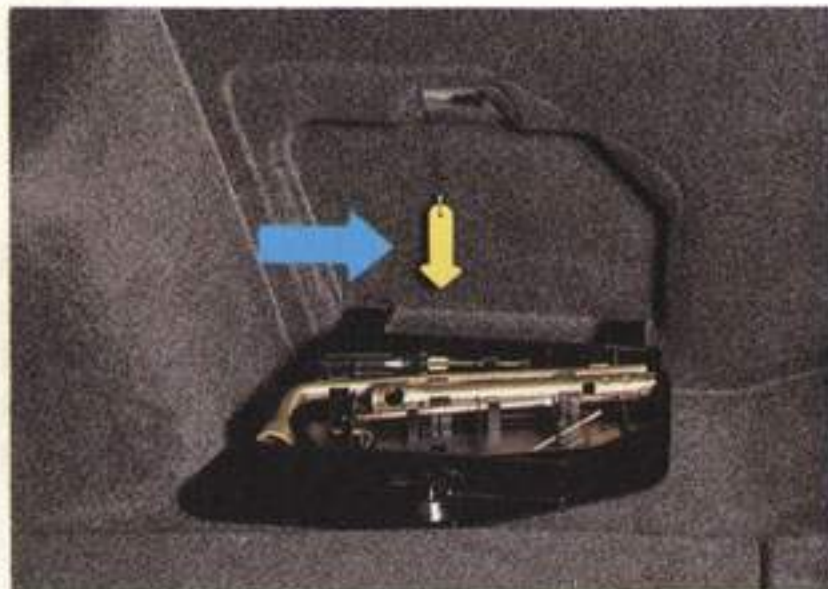

SG1290

Doors

The alarm cannot be activated if the driver door is open. If any of the other doors is open or is opened during the delay period and not closed until the delay period ends, this door is excluded from the alarm.

When this door is then closed a new delay period starts for this particular door and at the end of this period the door is included in the alarm.

When the door is closed the diode is lit for 10 seconds and then returns to flashing every other second.

Bonnet

If the bonnet is open or is opened during the delay period and is not closed before the delay period ends, the bonnet is excluded from the alarm.

When the bonnet is closed a new delay period for the bonnet starts and after this period the bonnet is included in the alarm.

When the bonnet is closed the diode is lit for 10 seconds and then returns to flashing every other second.

Boot lid

If the boot lid is open or is opened during the delay period and not closed until the delay period is over, the lid is excluded from the alarm.

If the boot lid is then closed a new delay period starts and the diode is lit for 10 sec-

onds and then returns to flashing every other second.

The boot lid can be opened with the remote control after the delay period has ended. Other doors and the bonnet are however still alarmed.

Signals when the alarm is tripped

When the alarm is activated, it is tripped by opening the boot lid, the bonnet or any of the doors. The glass sensor trips the alarm if any of the windows is smashed.

The alarm is also tripped by any attempt to use or short the ignition.

The following signals are given when the alarm is tripped:

- All indicator lamps flash for 5 minutes. If the alarm is deactivated during this time the flashing stops.
- An alarm sounds for 30 seconds. If the alarm is deactivated during this time, the alarm stops sounding.

Quick guide, light-emitting diode (LED)

	Status	LED Indicator
1	Activation (delay period)	illuminated for 10 seconds
2	Alarm activated (after delay period)	Flashes once every other second
3	Deactivating	illuminated 1 second
4	Alarm not activated	not illuminated
5	Door, bonnet or boot lid open/opened during delay period	1 flash/second for 10 seconds
6	Unlocking of boot lid	1 flash/second for 10 seconds
7	Closing of door, bonnet or boot lid after status 5 or 6 above	illuminated for 10 seconds
8	Only disconnection of starter motor, fuel pump and engine management system have occurred	Double flash every second
9	Fault in alarm system	Flashing instead of steady light during delay period

Starting and driving



Ignition switch and steering lock	62
Starting the engine	62
Running in	65
Gear changing	66
Cruise control	68
Braking	69
Traction Control System	70
Economical motoring	72
Driving in winter weather	73
Towing a trailer or caravan	74
Driving with the compact spare wheel fitted	75
Driving with a roof-rack load	76
Driving with the luggage compartment door open	76
Towing the car	76

Ignition switch and steering lock

The ignition switch has the following positions, turning the key clockwise from the locking position.

LOCK - Locking position

The locking position is obtained by turning the key anti-clockwise as far as it will go. This is the only position in which the key can be removed. The parking lights, hazard warning lights and interior lighting all work in this position.

Ignition switch



SG1162

⚠ WARNING

- Do not remove the key from the ignition switch until the car has come to a complete halt as the steering column lock will then be activated and the car cannot be steered. When the engine has stopped, servo assistance for steering and brakes is no longer available.
- Always remove the ignition key if children are left behind in the car.

OFF-position

The steering lock is not activated.

ON-position

The entire electrical system is operative. **Never leave the key in the drive position unless the engine is running.** Turn the key to the locking position and remove it.

Check-mode position

A check-mode position is provided between the ON and starting positions to enable the driver to check that the warning and indicator lights are working and that the pictogram lights up.

ST - Starting position

This operates the starter motor. When the key is released it will automatically return to the ON position. The car is equipped with a starter interlock device, which means that if the engine fails to start, the key must be returned to the LOCK position before it can be turned to the starting position again.

Starting the engine

The starter motor should not be run for more than 15 seconds at a time. Wait 20-30 seconds before running the starter motor again to give the battery time to recover.

Avoid racing the engine or putting a heavy load on it while it is cold. Drive off as soon as the oil warning light has been extinguished to enable the engine to reach its normal running temperature as soon as possible.

⚠ WARNING

When starting the car inside the garage, make sure that the garage doors are open to allow the poisonous carbon monoxide to escape.

A leaking exhaust system also causes a risk of carbon monoxide poisoning.

Starting the engine

The engine has an automatic choke and should be started as follows:

- 1 Depress the clutch pedal (man. gear-box). Do not touch the accelerator pedal.
- 2 Start the engine and let the ignition key spring back as soon as the engine is running (in very cold weather it may be necessary to keep the starter motor running for up to 15 seconds).

The engine of a car with automatic transmission can be started only when the selector lever is in the P or N position. Let the engine idle for around 10 seconds. Do not accelerate fully until the engine has run for at least 2 or 3 minutes.

N.B. The engine has hydraulic cam followers (which operate the valves) and these are completely service-free. The valve clearances are set accurately at the factory and will not require further adjustment.

In certain conditions, the hydraulic cam followers may emit a ticking noise that can be heard inside the car. This is most likely immediately after starting, before the oil pressure has reached its normal level.

It is also possible for air to enter the lubricating system when the oil or oil filter is changed or if the car has been left standing for a prolonged period. In this case, the ticking noise may be heard for as long as 15 minutes, but this is normal and does not indicate any malfunction.

However, do not exceed 3000 r/min until the noise has disappeared.

Each time the engine is switched off, the spark plugs are cleaned automatically.

Important points to note when driving the Saab 9000 Turbo

1 Starting and driving

- Never accelerate at full throttle before the reading on the temperature gauge is normal (N). If the needle on the pressure gauge repeatedly enters the red zone, a loss of engine power may be experienced owing to the safety cut-out system limiting the charging pressure. If this happens, take the car to an authorized Saab workshop without delay.
- Under certain atmospheric conditions, the needle may briefly enter the broken red zone, but this is normal and does not indicate a malfunction.
- The engine is also equipped with a safety cut-out to prevent the engine exceeding approx 6000 r/min.

2 Stopping the engine

- Do not rev the engine immediately before switching it off, but switch it off only when it is idling. This is to ensure that the turbo compressor is not run unnecessarily without adequate oil pressure.

3 Automatic Performance Control (APC)

- The system is optimized for 95 octane RON. One of the advantages of the APC system is that the engine can be run on petrol with a lower octane rating, although not lower than 91 RON, without harm. For optimum performance, however, the recommended 95 octane RON grade of fuel should be used.
- The APC system adjusts the boost supplied by the turbo to suit the knocking/pinking tendencies of the engine. Brief spells of knocking in the engine are perfectly normal. These may occur when a heavy load is put on the engine at about 3000 r/min and the extent of the knocking will depend on the grade of fuel being used.
- Isolated instances of knocking are more likely when low-octane fuel is being used. This controlled form of knocking followed by a reduction in the charging pressure merely indicates that the APC system is working normally, and is perfectly safe for the engine.
- However, if constant knocking occurs every time a load is put on the engine, this indicates a malfunction in the system and the car should be taken to an authorized Saab workshop.

Important considerations for cars with catalytic converter

IMPORTANT

Use only unleaded petrol. Use of leaded petrol will damage the catalyst and oxygen sensor and drastically reduce the performance of the device.

The catalytic converter is an exhaust-emission control device incorporated in the exhaust system. It consists of a honeycomb ceramic insert, the cells of which have their walls coated with catalytic material (platinum and rhodium).

To ensure that the catalytic converter functions properly and to avoid damage to the active constituents of the catalyst, the following points must be observed:

- Always keep the car properly serviced in accordance with the service programme. This applies particularly to the fuel and ignition systems.
- Always be alert to any misfiring of the engine (engine not running on all cylinders), any loss of power or any symptom of reduced performance. At the first sign of anything being wrong, reduce speed and take the car to an authorized Saab workshop as soon as possible.
- If the car is difficult to start (in severe cold or if the battery is flat) the car can be bump started (manuals only) or started with the use of jump leads from another battery (see the section on starting assistance). However, as soon as the engine has started, it is important that it runs on all four cylinders. If not, let the engine idle for a maximum of five minutes to give it time to run smoothly. If, after this period, the engine still misfires, get in touch with an authorized Saab workshop.
- Do not park on dry grass or other combustible material, as there is a risk of the hot catalytic converter causing a fire.

- NEVER drive off if the engine is misfiring!
- If the car is being bump started and the engine is already at about normal temperature, the engine must run on all four cylinders immediately after starting. If after a bump-starting attempt the engine fails to start immediately, do not attempt to start it again by bump starting.
- Failure to follow these directions can result in damage to the catalytic converter and associated components and may represent a breach of the warranty conditions.

Oxygen sensor-controlled ignition system

- 1 Oxygen sensor (Lambda sensor)
- 2 Catalytic converter

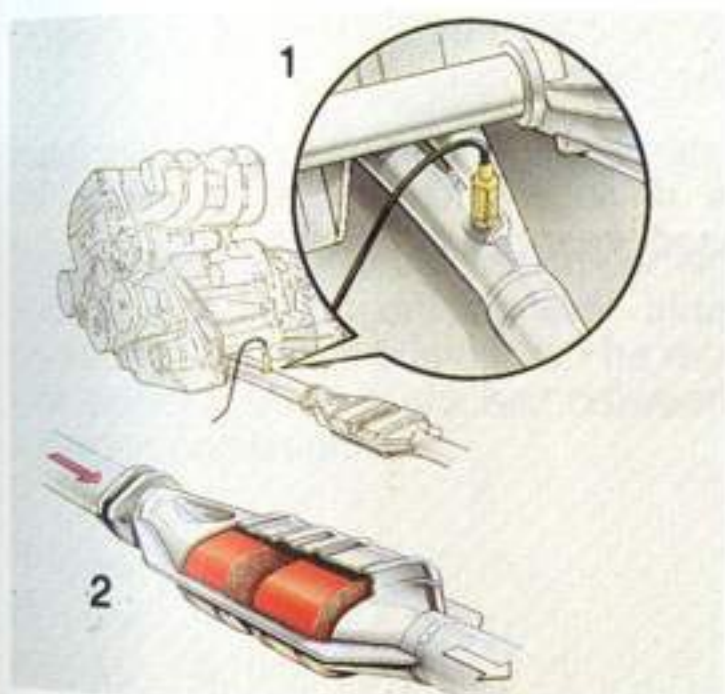

SG1292

Running in

Pistons, cylinder walls and bearings need time to bed in, to obtain uniform, wear-resistant surfaces. If a new engine is driven too hard, this gradual process of wearing in will not be possible and the life of the engine will be shortened.

During the first 1200 miles (2000 km) do not exceed 5000 r/min.

During the first 1800 miles (3000 km) never drive the car at full throttle other than momentarily.

Running-in of new brake pads

The running-in period for new brake pads is around 90 miles (150 km) of city driving or 300 miles (500 km) of highway motoring. To extend the service life, avoid hard braking during this period.

Fuel

Always make sure that you fill up with the right grade of fuel.

The fuel filler cap is located in the rear right wing.

Insert the fuel pump nozzle past the flange in the filler pipe and rest its first position marking (ring, "pimples" or the first turn of the spring) against the flange. Do not lift the nozzle while filling up is in progress.

IMPORTANT

Do not fill fuel all the way up the filler pipe - the petrol must be allowed room for expansion.

The fuel tank holds 66 litres. Screw on the filler cap until you hear a click.

The best way of avoiding condensation in the fuel tank (and consequent risk of malfunctioning) is to keep the tank fairly full at all times.

In cold weather it may be advisable to add methylated spirits or denatured alcohol a few times to eliminate any condensate that may have formed.

⚠ WARNING

- Never use petrol for any other purpose than as fuel for the car.
- Petrol is highly inflammable and can cause severe burns. Never use a naked flame in the vicinity of petrol. Never smoke when filling up with petrol.

Gear changing - manual transmission

The gear positions are marked on the gear lever. Before reverse gear can be engaged, the release ring underneath the gear lever knob must be lifted.

When changing gear, fully depress the clutch pedal and then release it smoothly. It is inadvisable to drive with one hand resting on the gear lever as this can increase the wear on the gearbox. When changing from fifth to fourth gear, do not press the gear lever sideways to avoid engaging second gear inadvertently, with over-revving

Gear positions and gear lever

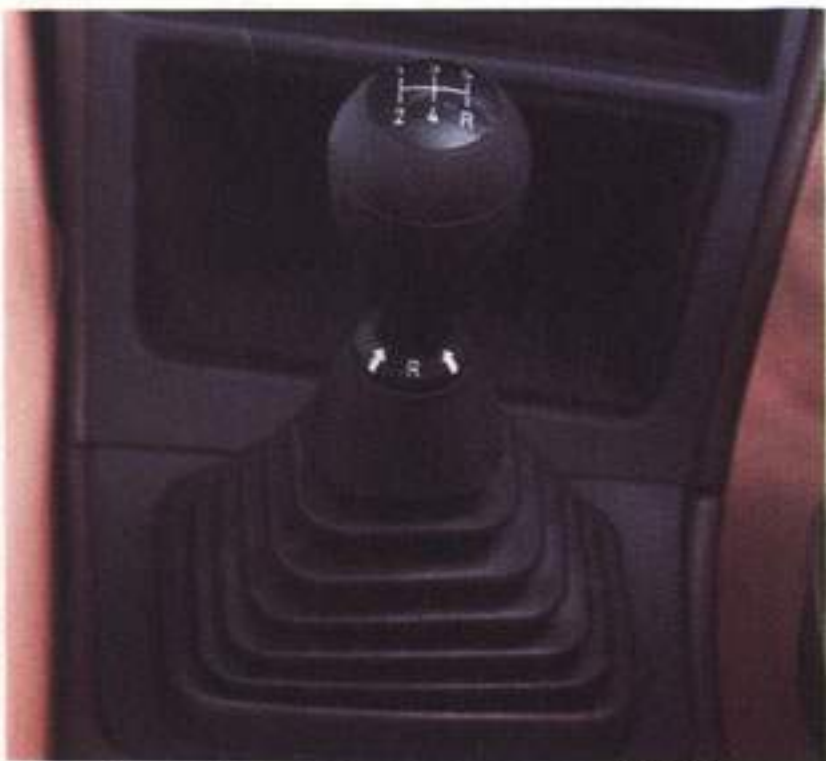

SG 500

and possible damage to the engine as a result.

When engaging reverse gear, make sure that the car is at a standstill and that your foot is off the accelerator. Move the gear lever firmly to the right in neutral before engaging reverse. The table shows the road speeds at which you should change up for maximum fuel economy.

Gear change	Road speed
1-2	15 mph (25 km/h)
2-3	25 mph (40 km/h)
3-4	40 mph (65 km/h)
4-5	45 mph (75 km/h)

Gear changing - automatic transmission

An illuminated dial with symbols that indicate the gear positions is located on the cowling around the base of the selector lever.

P = Park

R = Reverse

N = Neutral

D = 1st - 4th gear

3 = 1st - 3rd gear

2 = 1st - 2nd gears

1 = 1st gear only

} forward speed

WARNING

Do not select P, R or N while the car is moving, especially not at high speed. This could cause accidents or damage to the gearbox if a driving position is selected again.

Positions of selector lever

The engine should be idling and the car standing still when the selector lever is moved from one position to another. Accelerating the engine while moving the selector lever can cause abnormal wear of the transmission.

WARNING

Always keep your foot on the brake to keep the car from rolling when you select a drive position.

Do not rest your hand on the selector lever while driving, since this may cause increased wear of the transmission.

km/h). Manual selection is also inadvisable when the roads are icy. With the selector lever in this position, the transmission cannot shift up to a higher gear.

Kick-down

When the accelerator pedal is pressed down to the floor - to the kick-down position - the transmission will shift down one gear at a given road speed to achieve the best acceleration, such as on overtaking. The transmission will shift up one gear only if the engine speed is high, or if you ease off the accelerator pedal.

Cruise control

⚠ WARNING

Do not use the cruise control system on wet and/or slippery roads, in dense traffic or on winding roads. Set the switch to the OFF position if the system is not to be used. Cruise control may be inadvertently operated if the switch is left in the ON position.

Some variants are equipped with the Cruise Control system. The system is operated by a switch with the following positions:

- OFF (system inoperative)
- TIP (temporary speed reduction)
- ON (system operative)
- RESUME (system re-engaged)
- SET (for selecting the required speed).

The CRUISE indicator on the combined instrument is illuminated in the ON position and goes out in the OFF or TIP position.

To select the required speed

Move the switch to ON. Accelerate to the required speed (lowest speed: 25 mph or 40 km/h) and press SET.

To increase the selected speed

Accelerate to the required speed and then press SET. It is also possible to increase the speed by means of the SET control. Speed increases in steps (1.6 km/h) as long as the button is held depressed.

Temporary increase in speed

The system allows you to increase speed temporarily, for instance to accelerate for overtaking. When the accelerator is released, the system will then revert to the preselected speed.

Cruise control switches



Reduction in speed

The cruise control system is always cancelled by operation of the brake or clutch pedal. A smoother reduction in speed is obtained by moving the switch to position TIP.

However, the system can be brought into operation again for the preselected speed by holding the switch in the RESUME position for a few moments.

Speed can also be lowered using the RESUME button. Speed is lowered in steps (1.6 km/h) as long as the button is held depressed.

Disengaging the system

The cruise control system will be disengaged (switched off):

- if either the brake pedal or clutch pedal is depressed
- if the switch is moved to TIP
- if the switch is moved to OFF
- when the engine is switched off

NOTE:

Cars with 4 cylinder engines and TCS:

The brake pedal must be pressed once after starting the engine before the cruise control system can be operated.

Braking

When driving in alpine country and similar conditions, to avoid the risk of the brakes overheating on long descents, always use the braking effect of the engine by driving in a low gear.

In high-speed motoring, the life of the brakes can be increased by avoiding braking over long stretches. Instead, brake more firmly over a shorter period of time.

WARNING

It is good practice to try your brakes periodically while driving but particularly so if you have been driving through snow, slush or deep puddles or fords; if the brakes are wet, their efficiency may be drastically reduced until they dry out.

The car has power-assisted brakes and it should be remembered that the servo unit operates only when the engine is running. Much greater pressure on the brake pedal will be required to operate the brakes if the engine is switched off e.g. if the car is on tow.

ABS anti-lock brakes

To stop as quickly as possible, press the pedal hard down regardless of the condition of the road surface (dry, wet, slippery, etc.). The ABS system modulates the braking pressure to the respective wheels to maintain the maximum braking effect on the car, without loss of directional stability or steering control. A distinctive pulsating noise can be heard when the system is operating. Because operation of the ABS system will be initiated by only light pedal pressure if the road is slippery, you can test the condition of the road by trying your brakes and then adapt your driving accordingly.

Traction Control System (TCS)

The TCS system is designed to prevent the front wheels from spinning and thus to give the car the best possible grip, regardless of how slippery the road surface is.

This is achieved in the 9000 Aero with manual gearbox by a coupling between the control of the front brakes and the throttle.

Cars with V6 engine have an extra throttle which control this.

The advantages of the Traction Control System will be most apparent when friction conditions are different under the two driven wheels, such as:

- when starting and accelerating on a slippery road surface (wheelspin is counteracted and tractive effort is evenly distributed - cars with a manual gearbox) The system also operates when the car is reversing.
- on hill-starting (the effect achieved by the system in preventing wheel spin is similar to that when the driver slips the clutch to prevent the engine from stalling).
- on cornering (no additional power is transferred to the outside wheel, with automatic throttle control being used to give optimum cornering).
- when overtaking.

WARNING

The TCS system contributes to driver comfort and safety but must not be seen as a means to allow the car to be driven faster. The same amount of care must be taken on cornering and on slippery roads as would normally be the case.

TCS OFF button



SG1293

To switch off the TCS system

The system can be switched off manually using the TCS OFF button (TCS OFF shows on the main instrument), speed should not be higher than 60 km/h. The system can be reconnected using the TCS OFF button irrespective of the car's speed.

When starting the engine the TCS is always switched on.

If the cruise control is activated when the TCS starts to control the accelerator setting, the cruise control system will disengage after 1 second.

In case of fault (V6 engine)

If there is a fault in the TCS system (mechanical or electrical) the TCS OFF warning in the combined instrument stays lit.

The electronically controlled throttle is then completely open and there is no control. In this case the TCS system is entirely disconnected. The system should be checked by an authorized Saab workshop.

In case of fault (9000 Aero)

Should a fault arise in the system (the engine fails to respond to the accelerator), an emergency system can be engaged. To do this, release the accelerator pedal fully and then depress it again. It is now possible to continue driving, but with limited performance. The accelerator will also be stiffer.

WARNING

If the warning light comes on when you are driving, the emergency system will not be engaged unless you release the accelerator completely.

The performance of the car will then be reduced and greater force will be needed to depress the accelerator.

If you do not engage the emergency system, the car will not respond to the accelerator and the engine will run at idling speed only.

Note: In emergency mode, the cruise control and air conditioning systems will not be operative.

On the Aero model, a flashing TCS OFF lamp shows that the TCS system has been temporarily disconnected.

This is done to prevent overheating of the brakes if the Traction Control System has been in operation for a lengthier period of time.

A flashing TCS OFF light does not indicate a fault in the system.

When the ignition is switched on prior to starting, the light will come on as a check and both should go out soon after the engine has started running. It may take up to 60 seconds for the lights to go out, depending on the time it takes for the system to raise the correct hydraulic pressure.

Indicator light for TCS

This light, in the rev counter, comes on to indicate that the Traction Control System is in operation, i.e. when the grip of the wheels on the road is less than that needed to provide the desired acceleration. At the same time, you will notice that the engine is less responsive to the accelerator.

When the Traction Control System comes into operation it is an indication that the road surface is slippery, so drive with extra care when the indicator light is on.

Economical motoring

To keep fuel consumption down and to minimize wear, the car must be driven smoothly and gently, and be serviced regularly.

- Avoid hard acceleration and racing the engine (recommended speeds for changing gear are given under 'Gear changing').
- Frequent gear changing (e.g. town driving), short trips when the engine is cold, driving with a roof rack or trailer attached and running on studded snow tyres all increase fuel consumption.

Conditions affecting fuel consumption

Fuel consumption is greatly affected by the general driving conditions and the style of driving, the weather, the standard of the road, the condition of the car, the speed at which it is driven, etc.

Running-in

During the running-in period of 3000-4000 miles (5000-7000 km), the fuel consumption may be higher than what is normal.

Weather conditions

Fuel consumption may be as much as 10% better in summer than in winter. Fuel consumption is higher in cold weather owing to the longer time it takes for the engine to

reach normal temperature and for the transmission and wheel bearings to warm up. Fuel economy is also affected by the distance driven: short trips no longer than 3-5 miles (5-8 km) do not give the engine sufficient time to reach its normal running temperature. Strong winds can also affect fuel consumption. Read the graph as follows:

If the fuel consumption for the car with the engine at normal temperature is 28 mpg, then the actual fuel consumption after the car has travelled 3 miles (5 km) after starting from cold will be 23.5 mpg at an ambient temperature of 20°C (68°F) - an increase of 20%; 17.7 mpg at 0°C (32°F) - an increase of 60 %; and 14 mpg at an ambi-

Graph showing the increased fuel consumption at different outdoor temperatures on cold starting as against starting with the engine at normal temperature.

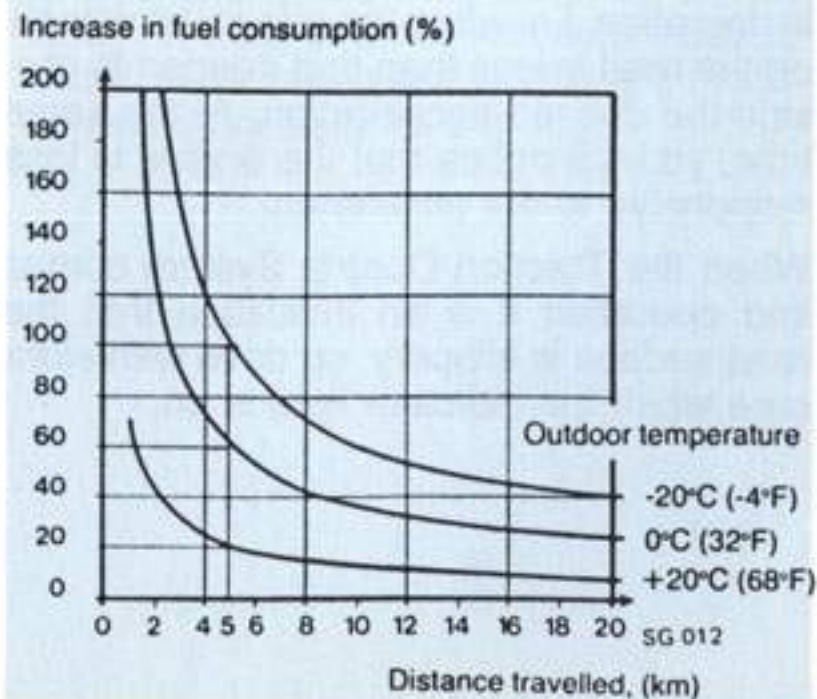

ent temperature of -20°C (-4°F) - an increase of 100%.

When starting from cold, the distance travelled by the car and the temperature outside greatly affect fuel consumption, as shown in the graph. For instance, if you use the car predominantly for short trips (3-5 miles), the average fuel consumption may be 60-80% higher than normal.

Driving style and technique

Driving at high speed and frequent acceleration, braking and gear changing all increase fuel consumption, whereas smooth driving will reduce it. Since engine revolutions are higher in the low gears at a given road speed, frequent or prolonged driving in low gears will increase fuel consumption.

For this reason, always change up to a higher gear as soon as the traffic conditions allow and drive in high gear for as long as possible.

Practical trials on the roads have demonstrated that substantial savings in fuel consumption can be made if these tips are followed.

Road conditions

Wet roads increase fuel consumption, as do gravel roads and driving in hilly country (the amount of fuel saved travelling downhill is less than the additional amount required for driving uphill).

The condition of the car

The general condition of the car is of great importance to fuel economy. For economical motoring, pay particular attention to the following:

- Make sure that the car is serviced regularly in accordance with the service programme.
- Make sure that the tyres are correctly inflated: if the tyres are soft their rolling resistance will be higher and fuel consumption will be increased. Refer to the 'Technical data' section for correct tyre pressures.
- A roof rack reduces the aerodynamic efficiency of the car and thus increases fuel consumption. Remove the roof rack when not in use.
- Towing a caravan or trailer greatly increases fuel consumption.

Driving in winter weather

Before driving off in cold weather, check that the wiper blades have not become frozen to the glass. Brush away any snow from the air intake for the heating system and, in extremely cold weather, apply suitable lubricant (molybdenum disulphide oil) to the door lock to prevent its freezing. If the lock has frozen, take care not to break the key when trying to unlock it. Heat the key first or apply some de-icing agent to it.

Now and again when refuelling in the winter, add fuel additives to prevent any condensation in the fuel tank from freezing and disrupting the fuel supply. To keep down the risk of condensation, keep the fuel tank full.

It is particularly important when the roads are slippery that the brakes and tyres are in good condition.

The car is fitted with tyres which provide exceptional grip on both wet and dry roads, although this has been achieved at the expense of somewhat reduced grip on snow and ice. For driving in these conditions, we therefore recommend that special winter tyres be fitted. These provide the best grip on icy roads, especially if fitted with studs.

If winter tyres are to be used, the same type of tyre must be fitted to all four wheels. Your local Saab dealer will be pleased to advise you of suitable tyres.

If your car has automatic transmission and you intend to use snow chains, the car should first be equipped with the winter tyres recommended in the 'Technical data' section.

WARNING

Do not exceed 30 mph (50 km/h) when using snow chains.

When using snow chains, inspect the links for wear at regular intervals.

Snow chains may cause deterioration of the road behaviour.

Do not use snow chains on the rear wheels.

If the car gets into a front-wheel skid, disengage the transmission by depressing the clutch (so that the wheels are freewheeling) and steer the front wheels in the direction you wish to go. At all costs, avoid touching the brakes. To control a rear-wheel skid, steer into the skid (i.e. steer in the direction the rear of the car is moving).

Driving in hot weather

- Always check the level of the coolant before starting a journey.
- Drive in as high a gear as possible, even uphill (this keeps engine revs down and helps to prevent overheating). On cars with automatic transmission, avoid using the kick-down position.
- At the end of the journey, let the engine run at idling speed for two or three minutes.
- If the temperature gauge pointer enters the red zone:
 - 1 Stop the car. If the car has AC or ACC, this system must be turned off, but do not turn off the engine. Do not take remove the cap of the cooling system expansion tank, even if the tank is empty. If the temperature continues to rise when the engine is idling, turn off the engine.
 - 2 Wait until the temperature gauge indicates normal temperature (around the middle of the scale) before turning off the engine. If the coolant needs to be topped up, carefully unscrew the expansion tank filler cap and add equal parts of water and Saab anti-freeze.
 - 3 Have the car inspected by an authorized Saab garage.

Towing a trailer or caravan

Towing attachment

A towing attachment, suitable for towing loads up to 1600 kg /3500 lb (9000 CD) and 1800 kg/4000 lb (9000 CS) is available as an accessory. A socket for connection of the trailer's electrical system is located underneath the floor trim adjacent to the rear light cluster on the left-hand side.

Trailer (or caravan) weight

WARNING

A trailer should not be towed if gradients of 15% or more are likely to be encountered. This is because the load on the driven front wheels will be so low that they are likely to lose their traction and start spinning, making further driving impossible. The handbrake will not always be able to hold the car and trailer stationary, as the wheels may slip on the road surface.

Make sure you are familiar with the law regarding speed limits for towing, maximum trailer weights and trailer braking requirements and also any special driving licence provisions.

Max. recommended trailer weight on different uphill gradients

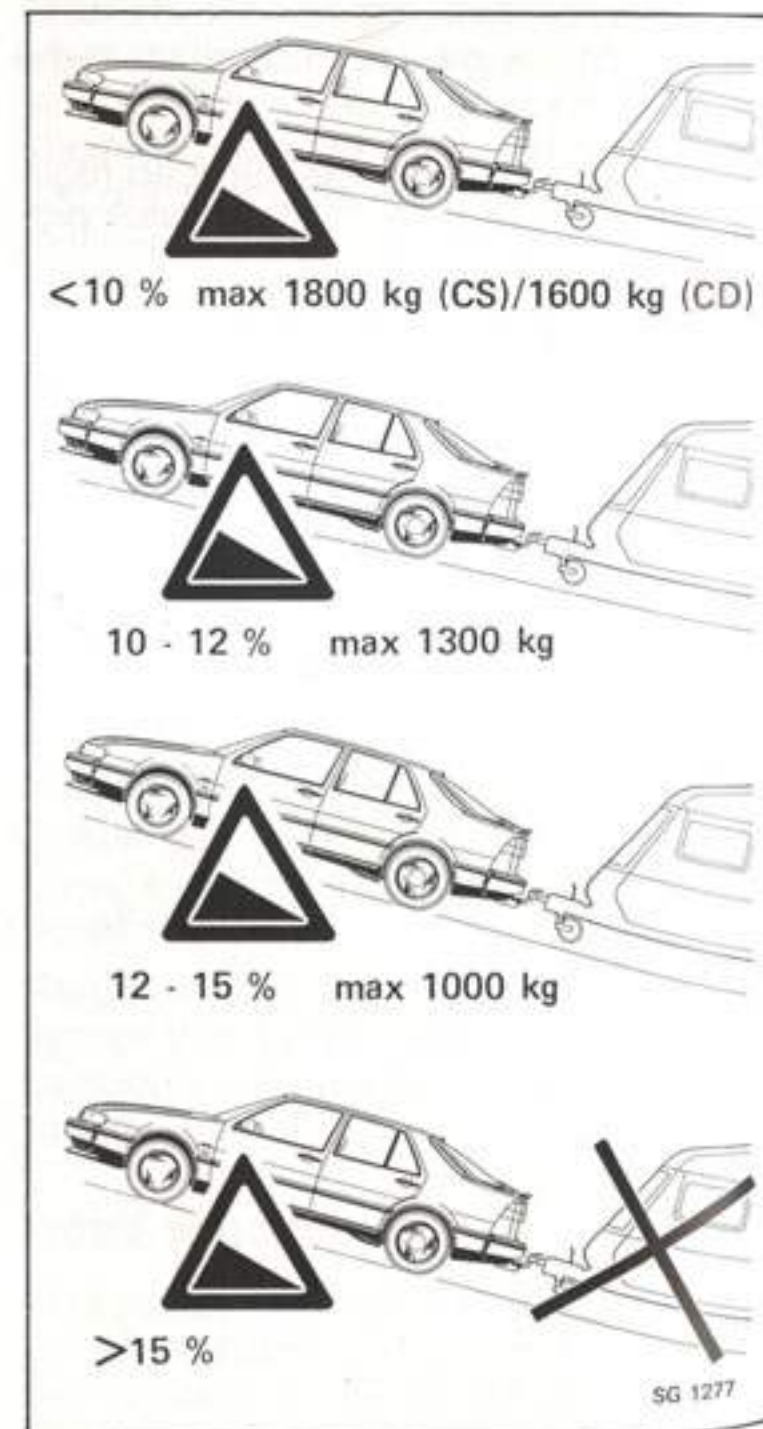

Towing-attachment load

The weight distribution of the trailer load makes a lot of difference to the handling properties of the car and trailer combination. On a single-axle trailer, whenever possible concentrate the load over the wheels and keep it as low as possible.

The load should be distributed such that the load on the towing attachment is between 50 and 75 kg (110-160 lb). Note that this load is part of the car's total load capacity and that the load in the boot may need to be reduced by a similar amount.

Driving

When towing a trailer always make allowance for the altered handling characteristics of the car and the reduced braking effect. The trailer brakes, springs and dampers greatly influence these characteristics.

On cars with automatic transmission, select first gear on very steep uphill and downhill gradients.

On steep uphill gradients, the engine cooling can be improved by setting the heater for maximum heat and running the heater fan at the highest speed.

Driving with the compact spare wheel fitted

Please observe the following when driving with the compact spare wheel (115/70 R16) fitted.

Do not drive any further than is necessary as the maximum life of the wheel is 2000 miles (approx. 3500 km). Change back to a standard wheel as soon as possible.

WARNING

Do not exceed 50 mph (80 km/h), as this may cause overheating of the tyre and deterioration of the road behaviour.

The tyre on the compact spare wheel should be inflated to a pressure of 4.2 bar (420 kPa).

Avoid driving too close to kerbs, as the ground clearance is lower when the spare wheel is fitted. Similarly, do not fit snow chains. The car must not be driven with more than one compact spare wheel. Do not fit a hub cap, as this would cover the warning text.

Spare tyre 175/70 R15 T

The car can optionally be equipped with a stronger spare tyre. The maximum speed for this tyre is 80 km/h and the tyre pressure must be 2.5 bar (250 kPa).

Driving with a roof-rack load

The maximum permitted load carried on the roof rack is 100 kg (220 lb).

Note that roof-rack loads are included in the car's carrying capacity.

The roof-rack mountings must be robust and able to withstand high stresses and the load must be securely lashed.

Do not exceed a road speed of 70 mph (110 km/h) when carrying long and/or heavy loads on the roof.

A roof rack designed specially for the car is available from your Saab dealer.

Roof rack mounting points



SG 410

Driving with the luggage compartment door open

Owing to the fact that driving with the luggage compartment door open enables exhaust fumes to be drawn into the car, this should be avoided whenever possible.

However, if this is unavoidable, close all windows, and set the heating and ventilation to maximum ventilation on the highest defroster setting.

If the car is to be driven with the luggage compartment door open, always lash the door securely to the bumper.



Front tow-rope attachment eye

SG1235

Towing the car

The car is equipped with towrope attachment eyes at the front and rear.

The 9000 Aero model has a special towing eye attachment stored in the spare wheel well under a panel in the luggage compartment floor. Open the cover in the spoiler and screw the towing eye attachment firmly in place.

Drive carefully and never exceed the speed limit for towing. Keep the tow rope taut. This is achieved by the driver of the towed vehicle braking carefully when necessary.



Rear tow-rope attachment eye

SG 813

⚠ WARNING

Remember that when the engine is not running, much greater pressure will have to be applied to the brake pedal as the servo for the power-assisted brakes will be inoperative. The same applies to the steering: without power assistance, the steering will be very heavy.

When towing a car with automatic transmission:

- The gear selector lever must be in the N position.
- Fill the transmission with 2 extra litres of fluid, over and above the normal amount. Use Dexron II ATF.
- National regulations on towing speeds must be observed. If legal, the highest towing speed permitted is 30 mph (50 km/h).
The longest towing distance permitted is 25-30 miles (40-50 km). If the car must be towed a longer distance, the front wheels must be raised from the ground.
- Before the car is driven again, check the transmission fluid level and adjust it to the prescribed level.
- The engine cannot be started by towing or pushing the car. It can be started as described in the section entitled "Boost starting using jump leads".

⚠ WARNING

Do not remove the key from the ignition switch as this activates the steering wheel lock and the car cannot be steered.

IMPORTANT

Since the handbrake acts on the rear wheels, make sure it is off when the car is towed with the front wheels raised off the ground.

Front tow-rope attachment eye (9000 Aero)



SG1264



Car care and maintenance

Engine	80	Compact spare wheel	99
Engine oil	81	Flat spots	100
Gearbox oil	83	Air conditioning (AC)	100
Coolant	83	Seat belts	101
Brake/clutch fluid and brake pads	85	Upholstery and trim	101
Steering system	86	Textile carpeting	102
Battery	86	Engine compartment	102
Boost starting using jump leads	87	Washing the car	102
Alternator	88	Waxing and polishing	102
Wipers and washers	89	Touching-up the paintwork	103
Headlight alignment	90	Anti-corrosion treatment	103
Changing bulbs	90	Service Programme	104
Fuses	96	Motoring abroad	104
Wheels and tyres	97		

Engine

Four-cylinder engines

All models have front-wheel drive and a transverse-mounted 2.0-litre or 2.3-litre engine. The engine is a water-cooled, four-cylinder, in-line engine with twin overhead camshafts and 16 valves. The cylinder head is inclined forward at an angle of 20°. The engine is also equipped with an exhaust emission control system.

The engine is equipped with two counterbalance shafts which reduce engine vibration to a minimum.

The counterbalance shafts are chain driven and rotate at twice the crankshaft speed. They produce forces and moments that are

Counterbalance shafts

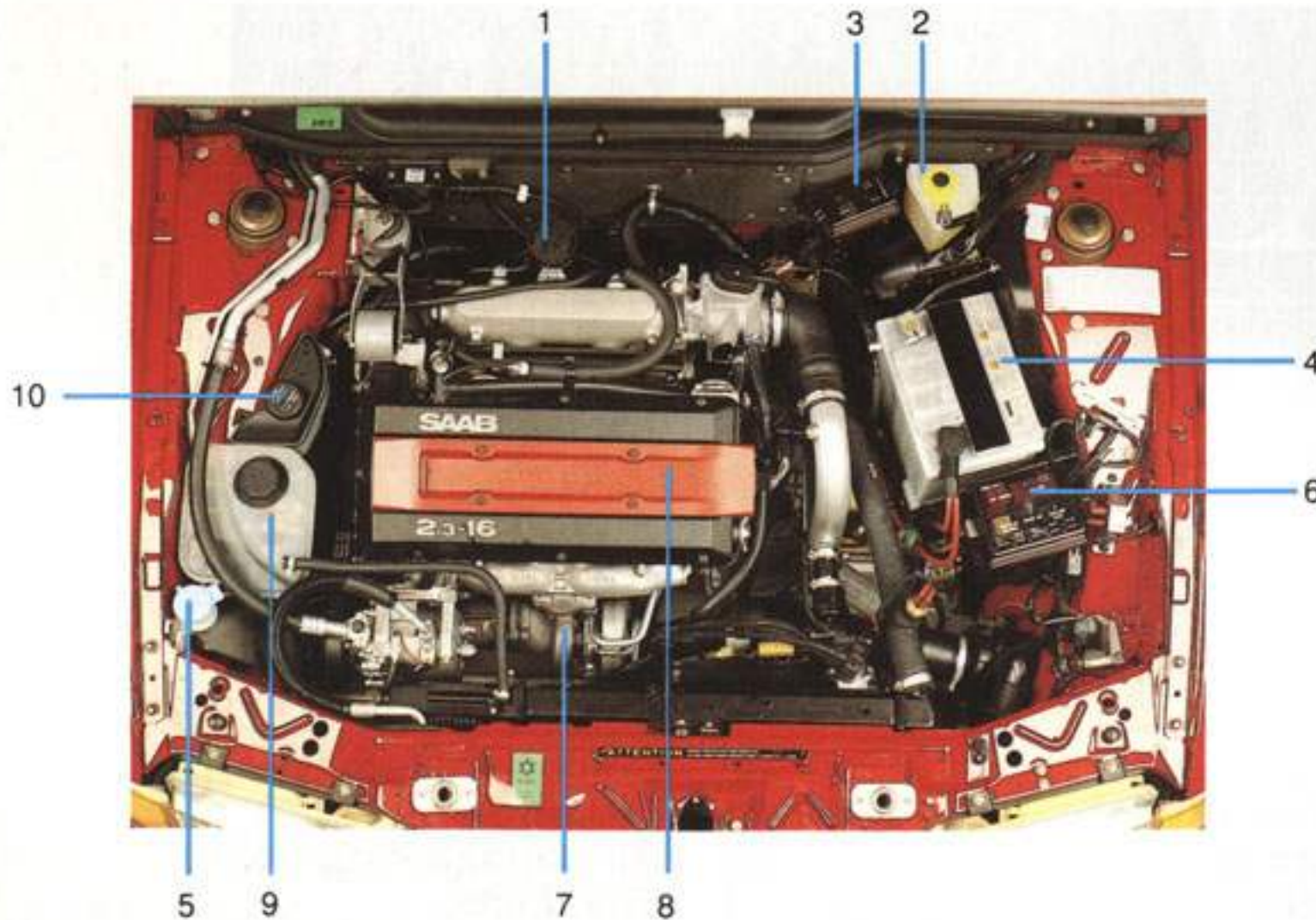
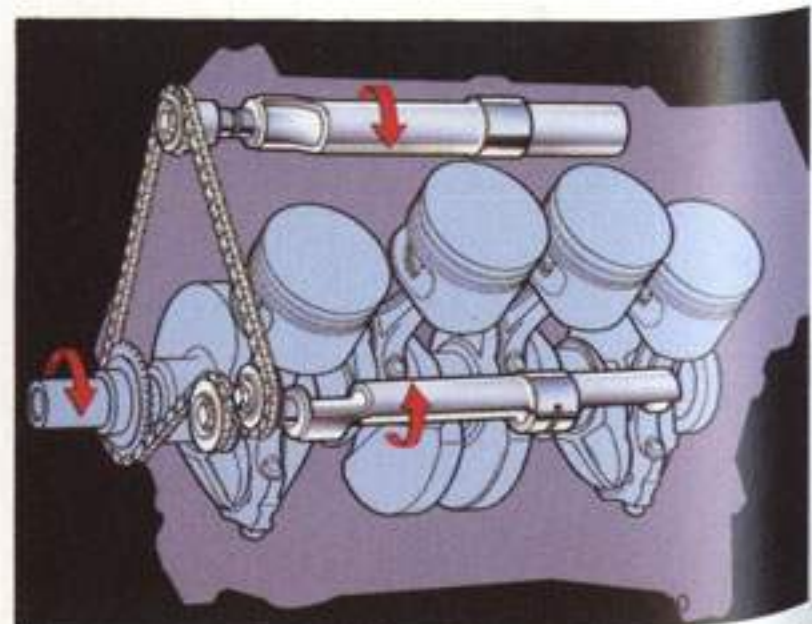

Engine compartment, Turbo models

- | | |
|--|---------------------------------------|
| 1 Engine oil dipstick | 6 Front electrical distribution box |
| 2 Brake/clutch fluid reservoir | 7 Turbocharger |
| 3 Electrical distribution box for ABS system | 8 Ignition cartridge |
| 4 Battery | 9 Cooling system expansion tank |
| 5 Washer fluid reservoir | 10 Fluid reservoir for power steering |

opposed to those generated by the pistons and connecting rods, an effect occurring twice during each revolution of the engine. The result is that vibrations from the moving parts of the engine are counteracted, and undesirable engine noise is reduced.

The gearbox is at the right-hand end of the engine (viewed from the front) and forms an integral unit with the engine.

Engine oil

Check the oil level in the engine regularly. Make sure the car is on level ground and allow the engine to cool from normal temperature for between two and five minutes. Remove the dipstick, wipe it on a clean rag and then check the level.

The level must never be allowed to drop below the minimum mark on the dipstick, but nor should the level be topped up higher than the maximum mark as this may result in excessive oil consumption. The distance between the maximum and minimum marks on the dipstick corresponds to approximately one litre (1.75 imp. pints).

Top up as necessary with oil of the recommended grade through the dipstick tube. Do not add oil if the level is higher than midway between the maximum and minimum marks on the dipstick. Make sure that the dipstick is screwed down tightly (finger-tight) after use.

The engine oil should be changed at the intervals specified in the service programme.

More frequent oil changes may be neces-



*Oil filler cap and dipstick
(4-cyl. engines)*

SG 419

sary if the car is driven in any of the following cases:

- frequent and lengthy periods with the engine idling
- repeated stop-go driving
- short distances in cold weather when the engine has no time to reach normal operating temperature.

If the car is driven under any of the above conditions, changing the oil at 10,000 km intervals is recommended.

To change the oil, make sure that the engine is warm. Unscrew the drain plug in the bottom of the sump and leave the oil to drain into a suitable receptacle for at least ten minutes. Keep your hands away from the oil as it is likely to be hot.

Refer to the 'Technical Data' section for de-



Drain plug in sump (4-cyl. engines)

SG 420

tails of the recommended oil grade and quantity and, after filling, check the oil level on the dipstick as described above.

WARNING

Lengthy and repeated contact with engine oil may be harmful to the skin and a certain possibility of contracting cancer cannot be altogether ruled out.

Avoid getting oil on your skin as far as possible and wash it off meticulously with soap and water.

Do not touch the turbo system and/or manifold, which can become very hot after driving.

Do not spill oil on hot parts of the engine, as this can cause fire.

V6 engine

The engine is a water-cooled 3.0 litre V6 engine with double overhead camshafts and 24 valves. The cylinder block is mounted transversely in the engine compartment. The engine is equipped with an exhaust emission control system.

To check/change oil, see previous page.

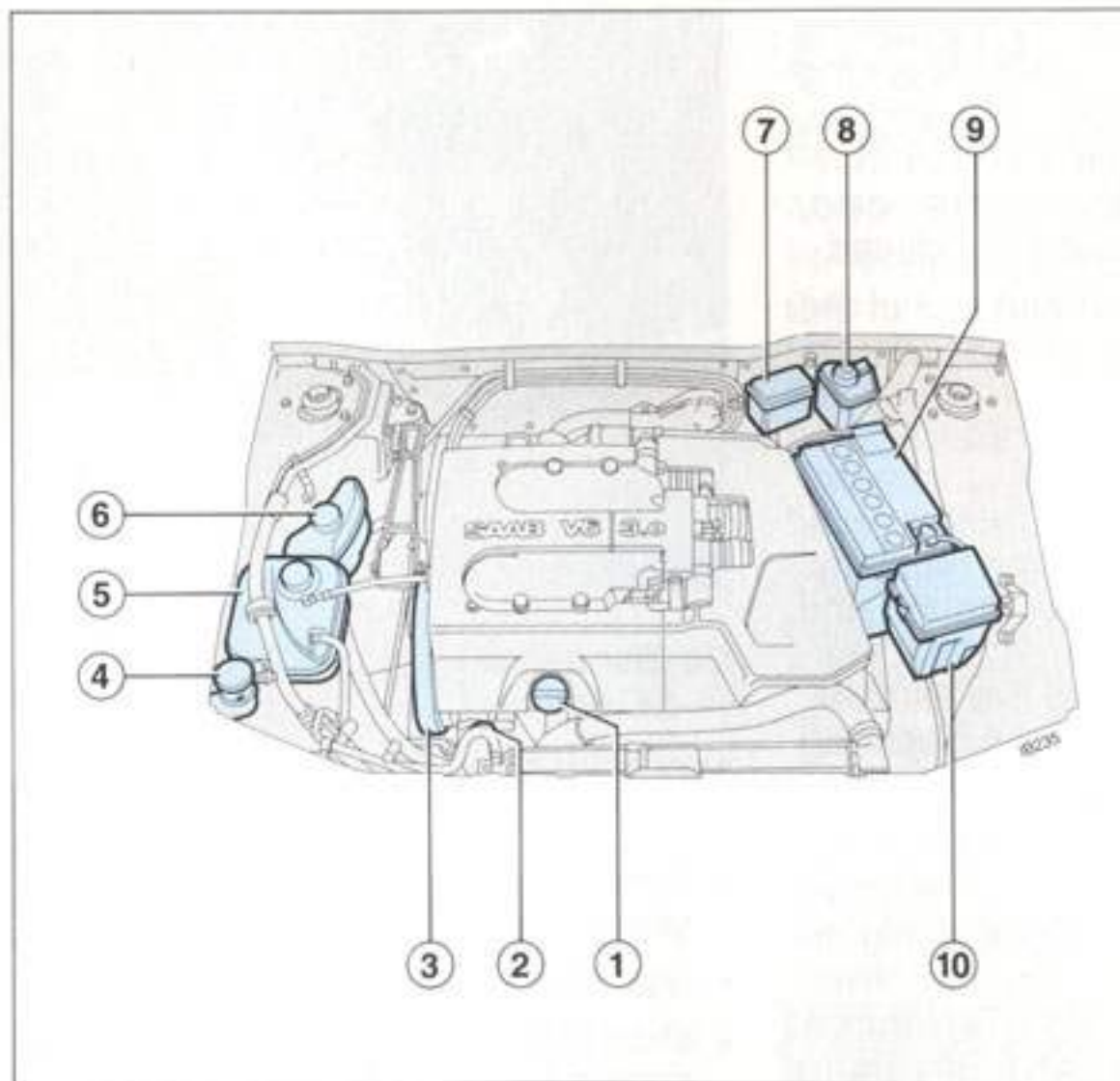
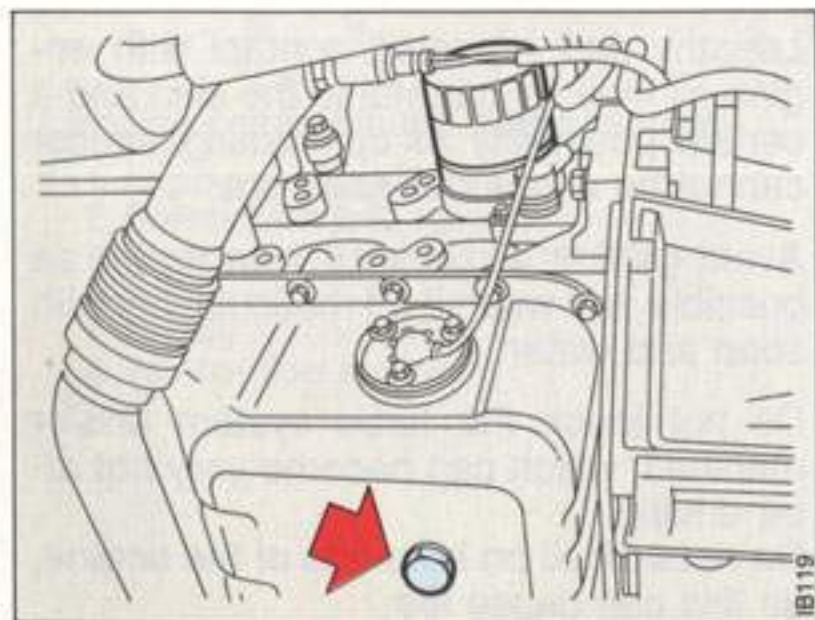
Drain plug (V6 engine)**Engine compartment, V6 engine**

- 1 Oil filling, engine
- 2 Oil dipstick, engine
- 3 Drive belt
- 4 Washer fluid reservoir
- 5 Expansion tank, cooling system
- 6 Servo control fluid reservoir
- 7 Distribution box for ABS brakes
- 8 Brake/clutch fluid reservoir
- 9 Battery
- 10 Front distribution box

Gearbox oil

Manual gearbox

Check and top up as indicated in the service programme. The gearbox oil should not be changed.

Automatic transmission

Check the fluid level in the transmission regularly, as follows:

- Park the car on a level surface and apply the handbrake. When checking the fluid level, the transmission must be at operating temperature (around +176°F +80°C).
- Set the selector lever to P or N and let the engine idle.

Dipstick for automatic transmission fluid



SG1227

- Wipe the dipstick with a lint-free cloth.
- The transmission fluid dipstick has two sets of MIN and MAX marks. The fluid level should be between the upper MIN and MAX marks if the fluid is at operating temperature. Top up with fluid of the prescribed type as required. See the section entitled Technical Data. The distance between the marks is equivalent to around 0.5 litres. Add fluid through the dipstick tube. If the ambient air temperature is low (below 32°F or 0°C), the correct level may be in the lower section of the upper MIN/MAX scale, since the fluid will not reach +176°F.

Coolant

The expansion tank is transparent to facilitate checking of the coolant level. The level should be between the MAX and MIN marks on the side of the tank. Top up as necessary with equal parts of water and Saab anti-freeze. After filling an empty expansion tank, run the engine to normal temperature and then top up again as required.

Coolant

The cooling system is charged at the factory with a coolant containing 50% special anti-freeze with corrosion inhibitor. The mixture should never be weaker than this owing to the risk of corrosion. For protection in extreme weather conditions, a higher concentration will be necessary.

Coolant expansion tank



SG1165

84 Car care and maintenance

For protection at -50°C (-58°F), a 60% concentration of anti-freeze will be required.

The corrosion inhibiting properties of the coolant deteriorate in time. Saab original coolant must be used all the year round. Change the coolant as indicated in the service programme. Always use genuine Saab coolant. Anti-freeze of other makes may require changing at more frequent intervals and may also be detrimental to the car.

N.B. When adding anti-freeze to the coolant, always mix it with water in the required proportions first. If neat anti-freeze is added, the engine may still be damaged by frost as the anti-freeze will not be distributed throughout the cooling system until the thermostat has opened to allow full circulation.

⚠ WARNING

Take care when opening the bonnet if the engine is boiling. Never open the filler cap on the expansion tank while the engine is hot. Allow the engine to cool down before removing the cap.

The cooling system is pressurized. Always open the filler cap on the expansion tank carefully to release the pressure before removing the cap completely.



Radiator drain plug

SG 805

Changing the coolant

- 1 If the engine is hot, open the filler cap on the expansion tank carefully to release the pressure in the system. Do not remove the filler cap.
- 2 Place a suitable receptacle under the radiator and unscrew the drain plug.
- 3 Remove the filler cap on the expansion tank.
- 4 After the system has been drained completely (after about two minutes) tighten the drain plug. **N.B.** Finger-tight only.
- 5 Mix the anti-freeze solution with water to the required strength in a watering can or other suitable receptacle, using only Saab-approved anti-freeze.

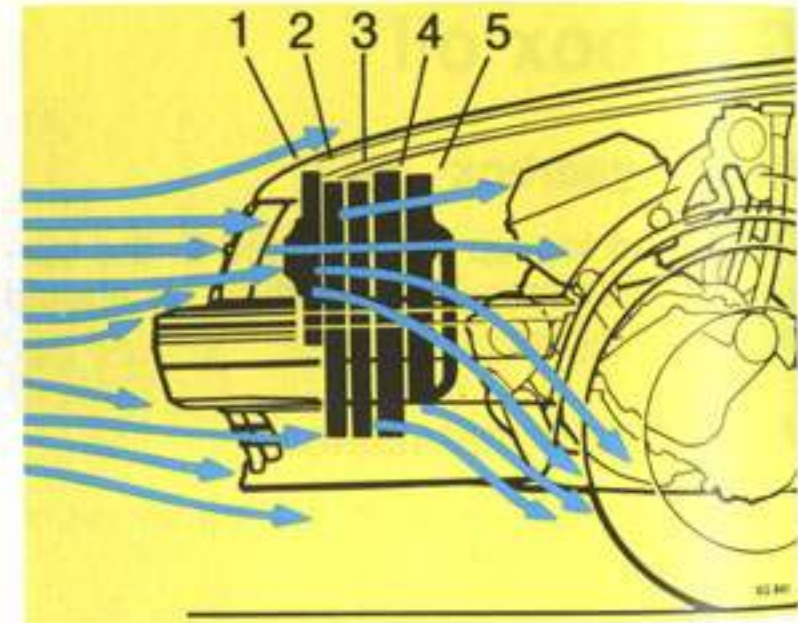

Radiator assembly

SG 841

- 1 Fan for AC condenser (certain markets)
- 2 AC condenser (coolant/air)
- 3 Intercooler (air/air)
- 4 Ordinary engine radiator (coolant/air)
- 5 Radiator fan

- 6 Pour the coolant mixture into the expansion tank. This will take a couple of minutes as air must be allowed to escape.
- 7 Replace the filler cap firmly and run the engine to normal temperature. Top up the coolant as required to bring the level between the **MAX** and **MIN** marks on the tank.
- 8 Check the coolant level again in a few days and top up as necessary.

Brake fluid and brake pads

Checking

The combined reservoir for brake and clutch fluid is transparent, to facilitate checking of the fluid level. The level should be between the MAX and MIN marks.

On cars equipped with the Traction Control System and a manual gearbox, the ignition must be switched on when the brake fluid level is checked. Top up as necessary with brake fluid of the recommended grade.

For topping up, use only fluid that has been stored in a closed container. Check that there are no leaks in the brake system.



Brake/clutch fluid reservoir

SG1238

*Brake/clutch fluid reservoir
(9000 Aero with TCS)*



SG1175

In time, the brake fluid will absorb water and vapour may be formed. It is therefore vital that the brake fluid be changed at the intervals specified in the service programme. This work should be done by an authorized Saab workshop.

Since the footbrake and handbrake have automatic adjustment, it is not possible to detect, by signs of excessive pedal travel or lever movement, when the brake pads are worn and need replacement. Thus, it is vital that the thickness of the linings be checked regularly as specified in the service programme.

The work of changing the brake pads and adjusting the handbrake cable must be carried out by an authorized workshop using genuine Saab brake pads.



Power steering fluid reservoir

SG1166

Steering system

The level of the fluid in the power steering reservoir must be checked regularly as specified in the service programme. The reservoir has graduations for cold and hot fluid. When the engine is at normal running temperature, the fluid level should be between the HOT and COLD marks.

If the level is checked when the engine is cold, the level should be between the COLD and the ADD marks.

Use "Saab Power Steering Fluid 1890".

Never start the engine with the fluid reservoir filler cap off as the fluid might then gush out of the reservoir under pressure.

Battery

⚠ WARNING

The battery emits hydrogen which, when mixed with the oxygen in the air, forms the highly explosive gas oxyhydrogen.

Always avoid causing sparks or using a naked flame when working in the vicinity of the battery. Since the battery contains corrosive sulphuric acid, always wear a face mask or protective goggles when carrying out any work involving the battery.

Should the acid come into contact with your eyes, skin or clothes, wash the affected areas immediately with plenty of water. In the event of it getting into your eyes, or if a large quantity of the acid gets on your skin, call a doctor without delay.

The car battery is sealed-for-life and under normal conditions will not require maintenance. Refer to the "Technical Data" section.

Check the charge of the battery at regular intervals and more frequently during the winter when the battery's capacity will be reduced by low temperatures. The check can be made by noting the voltage drop on starting the engine. As a basic guide, the voltage should not drop below approx. 11 V

at an ambient temperature of +20°C (68°F) nor below approx. 10 V at -10°C (14°F).

If the car is used repeatedly for only short journeys during the winter, the battery may need extra charging - either by means of a battery charger or by taking the car for a longer run.

The battery may also be checked by using a hydrometer to check the specific gravity of the electrolyte, which should be 1.28.

Battery



SG1294

Always make sure that you connect the red positive (+) lead to the positive (+) battery terminal and the blue negative (-) lead to the negative (-) battery terminal. Always disconnect the positive (+) battery lead before connecting a battery charger to boost the battery.

IMPORTANT

Never reverse the polarity of the battery. If the battery leads are connected to the wrong terminals or either of the battery or alternator leads is disconnected while the engine is running, the alternator may be irreparably damaged.

Boost starting using jump leads

To avoid arcing or flashover, jump leads for boost starting must be connected correctly.

- 1 Switch off the ignition and all power consumers (lights, rear window heater, etc.).
- 2 Switch off the engine in the donor car.
- 3 Start by connecting the positive terminal of the donor car battery to the positive (+) terminal of the flat battery. Next connect the negative (-) terminal of the donor car battery to the engine's lifting eyebolt, for example, of the faulty car, furthest away from the battery.

⚠ WARNING

Do not connect the negative (-) lead from the donor car to the faulty car battery because a spark could ignite the explosive gas in the battery.

- 4 Start the donor car and then start the engine in the faulty car. Let it run for a while before disconnecting the jump leads in the reverse order.

Connecting jump leads for boost starting

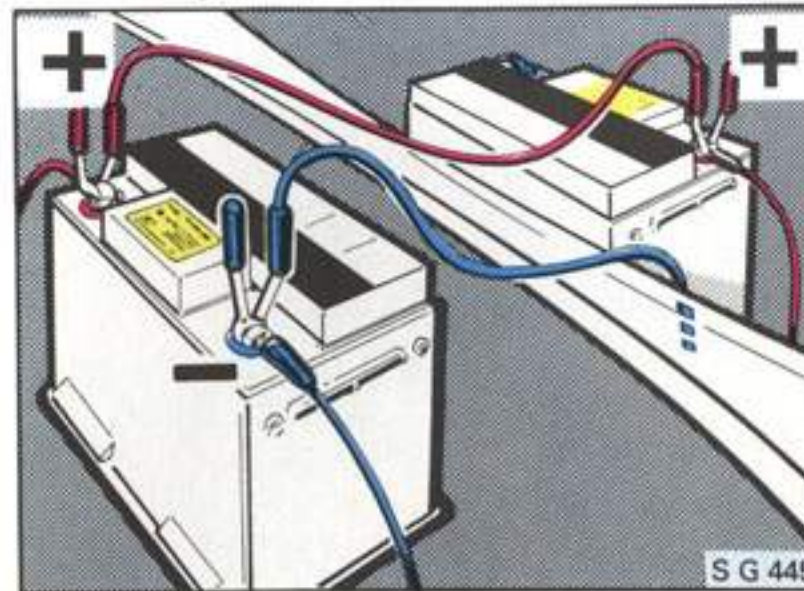

Alternator

The alternator is located to the left of the engine, adjacent to the false bulkhead panel. The alternator is driven by a multi-groove belt from the crankshaft pulley.

WARNING

Make sure that loose garments do not become caught in the drive belt when the engine is running.

Multi-groove belts last longer than conventional vee-belts and can also transmit a higher torque.

It is very important that the belt has the correct tension. The belt tension is maintained with an automatic tensioner.

See also page 7 "Charging warning light".

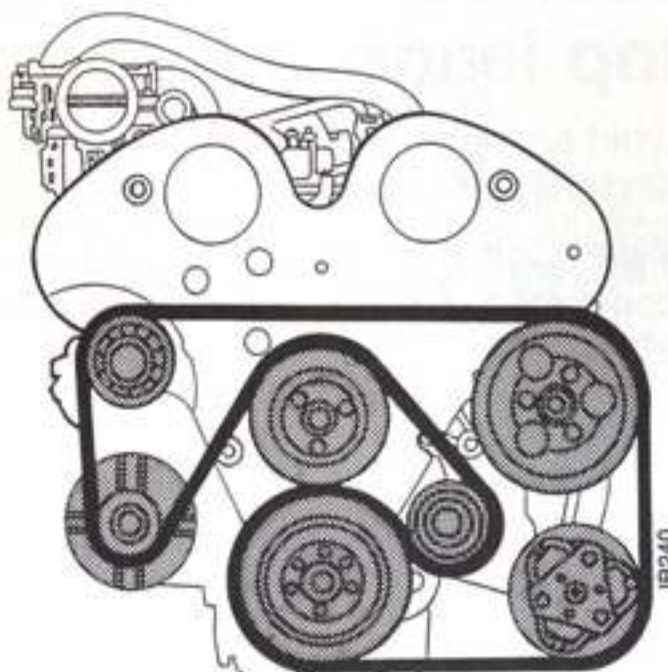

Drive belt (3.0-litre V6 engine)

IB 240

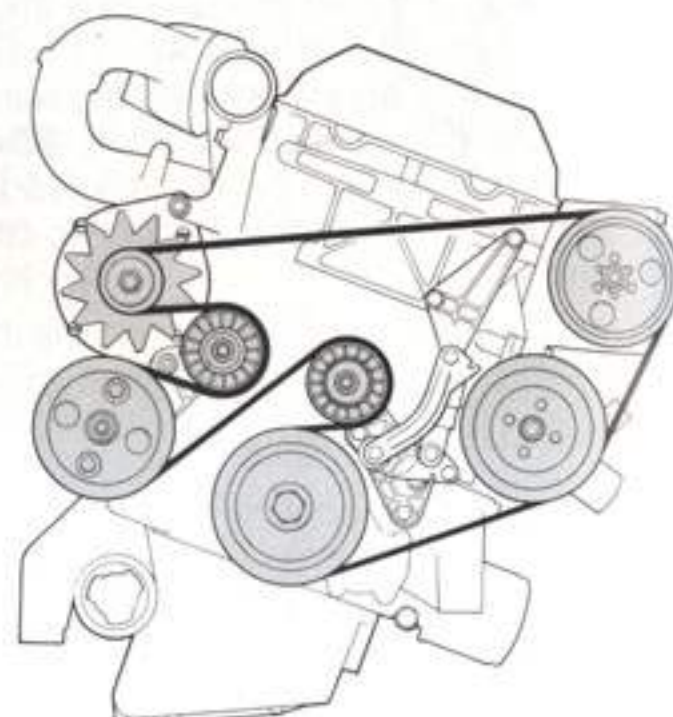

Drive belt (2.0- and 2.3-litre engine)

SG1251

Wipers and washers

Regularly check and clean all wiper blades. Saab washer fluid is recommended for cleaning.

If the wiper is not functioning properly, clean the window with Saab washer fluid. This is especially important after an automatic car wash as they sometimes use wax treatments that coat the windscreen.

If the quality of the wipe is still unsatisfactory, change the wiper blades. The wiper blades should be changed if they show any signs of wear.

Changing the windscreen and rear window wiper blades

Pull the wiper arm away from the glass. Depress the catch and pull the the wiper blade assembly down so that it disengages from the arm. Remove the blade assembly from the arm.

Lift the wiper arm away from the glass and detach the blade by holding the middle and pulling it away from the arm. To fit the new blade, slide the blade into the clips and press it firmly home.

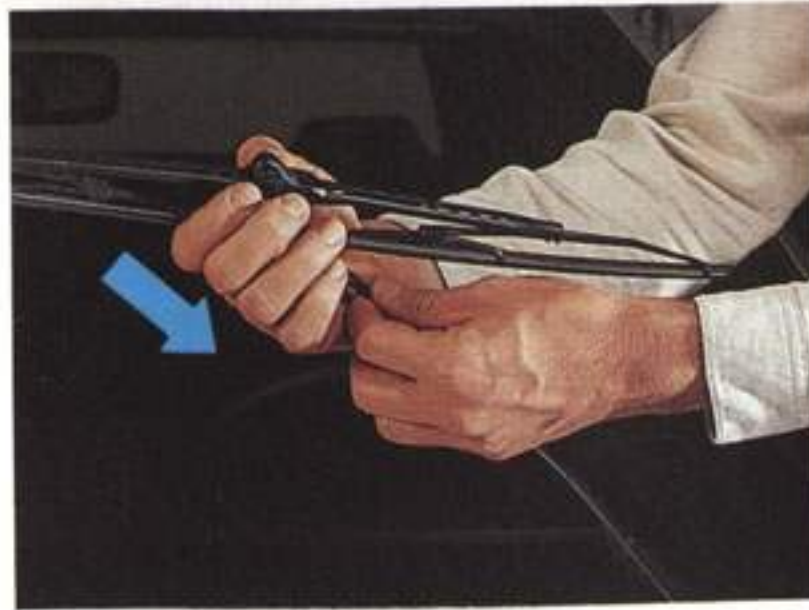

Removing the windscreen wiper blade SG 428

Removing the headlight wiper blade



SG429



Washer fluid reservoir SG1296

Washers

The washer fluid reservoir holds 4 litres of fluid. The indicator light comes on when only about 0.8 litres of fluid remains in the reservoir. About 0.1 litres of this amount is for the rear window washer (9000 CS with rear window wiper). Top up with equal parts of Saab washer fluid and water.

The washer nozzles are adjustable. Insert a pin or the like in the jet hole and swivel to the correct position. The rear window washer nozzle on the 9000 CS is mounted on the right in the high-level brake light.

Headlight alignment

⚠ WARNING

Switch off the engine before adjusting the headlamps to avoid getting your hands and fingers injured by rotating parts in the engine bay.

Adjustment of the headlights is made by means of two knobs at the back of each headlight unit. The knobs are accessible from the engine compartment.

The top knob is for vertical adjustment and the bottom one for lateral adjustment. A screwdriver is required for vertical adjustment of the headlights.

Headlight adjustment knobs

- 1 Lateral adjustment
- 2 Vertical adjustment

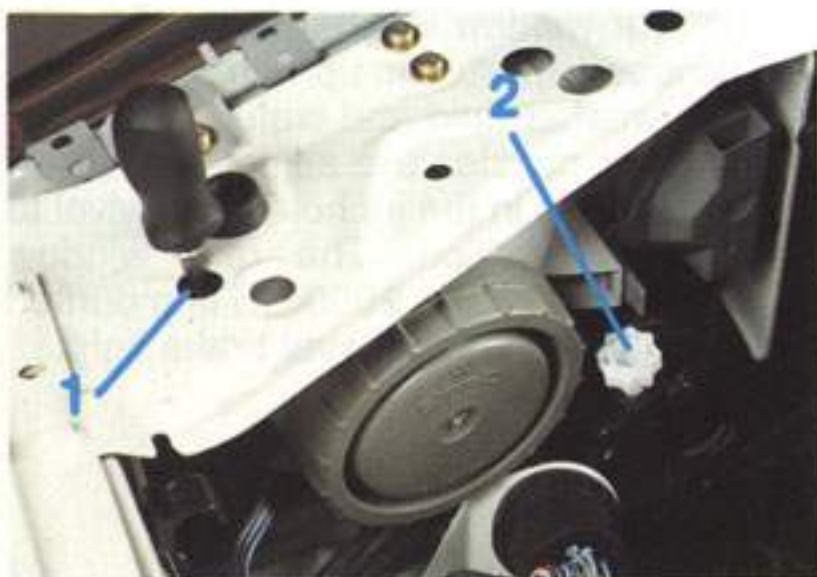

SG1155

Changing bulbs

⚠ WARNING

Switch off the engine before changing any bulb to avoid getting your hands and fingers injured by rotating parts in the engine bay.

Changing the headlight bulb

- 1 Dipped beam bulb
- 2 Parking light bulb

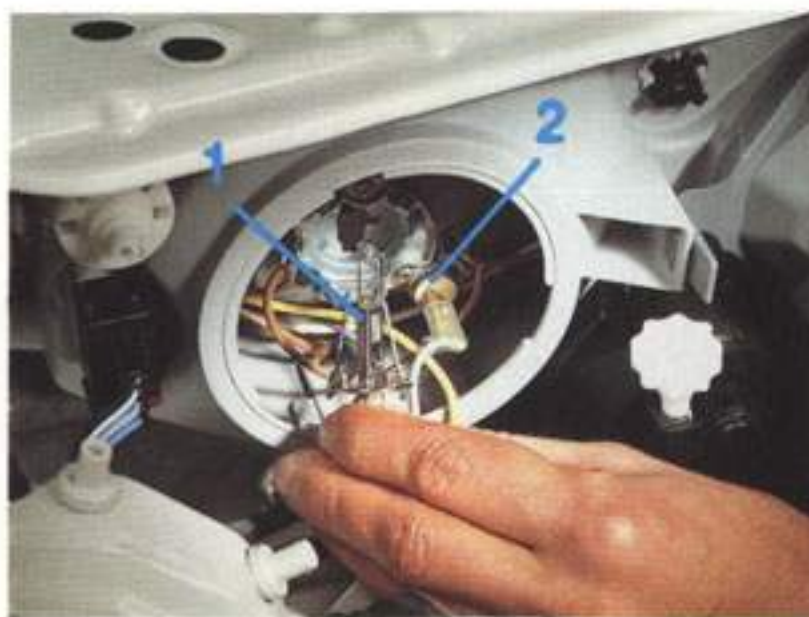

SG1156

Headlights, dipped beam and parking lights

Unscrew the cover on the rear of the headlight. To unhook the spring clip holding the dipped-beam bulb, first press the clip forwards and then towards the middle. Take out the bulb and unplug the connector.

Insert the new bulb, without touching the glass envelope with your fingers. Fit it in the reflector, making sure that the lugs engage in the slots, and clamp it in place with the spring clip.

Do not fit bulbs with a higher rating than 55W.

The parking light bulb is located beside the dipped beam bulb. Disconnect the leads and change the bulb.

Headlight, full beam (9000 CS)

Open the plastic cover by pressing the tongue to the side and pulling it straight out. Remove the cover by first withdrawing its lower bracket and then its upper one. Disconnect the leads and unhook the spring clip.

Remove the bulb. Fit the new bulb, taking care not to touch the glass with your fingers.

Do not fit bulbs with a higher rating than 60/55W.

Make sure the bulb holder engages with the slots in the reflector and secure it with the spring clip.

Changing the full beam lamp



SG1154

Front light clusters

Undo the retaining clamp. Carefully withdraw the light cluster. The bulb holder has a bayonet fitting. Grasp the two plastic tongues and twist the bulb holder anticlockwise.

Pull the bulb holder out of the fitting and change the bulb. Ensure that it is firmly located and makes good contact.

When refitting the light cluster, make sure that the peg engages with its hole in the body.

Front light cluster

- 1 Direction indicator
- 2 Retaining clamp
- 3 Peg



SG1297

Rear light cluster (9000 CD)

The bulbs in the rear light clusters are accessible from the luggage compartment.

Release and carefully remove the cover together with the associated bulb holder. Change the bulb.

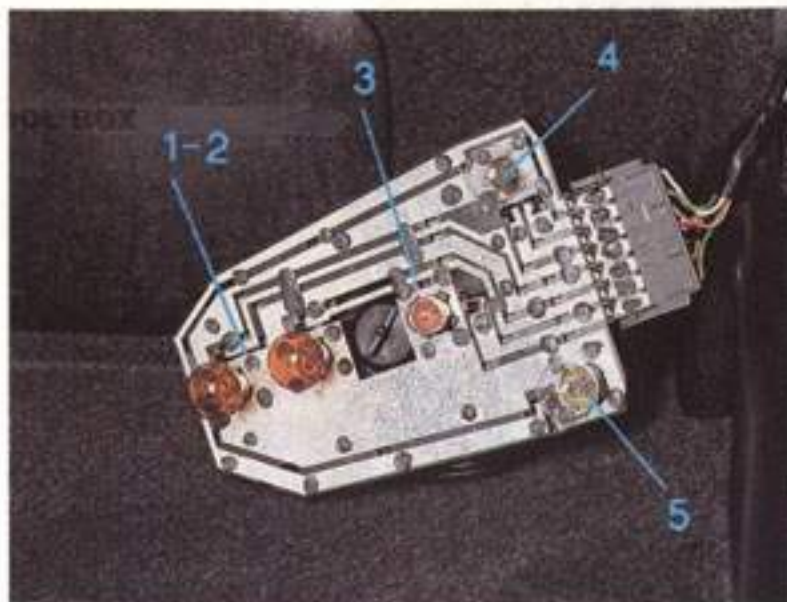

Rear light cluster (9000 CD)

SG1299

- 1,2 Indicators
- 3 Tail light
- 4 Brake light/Tail light
- 5 Reversing light

Rear lights (9000 CD)

- 1 Indicator
- 2 Indicator
- 3 Tail light
- 4 Brake light/Tail light
- 5 Reversing light
- 6 Rear fog light
- 7 Reflex

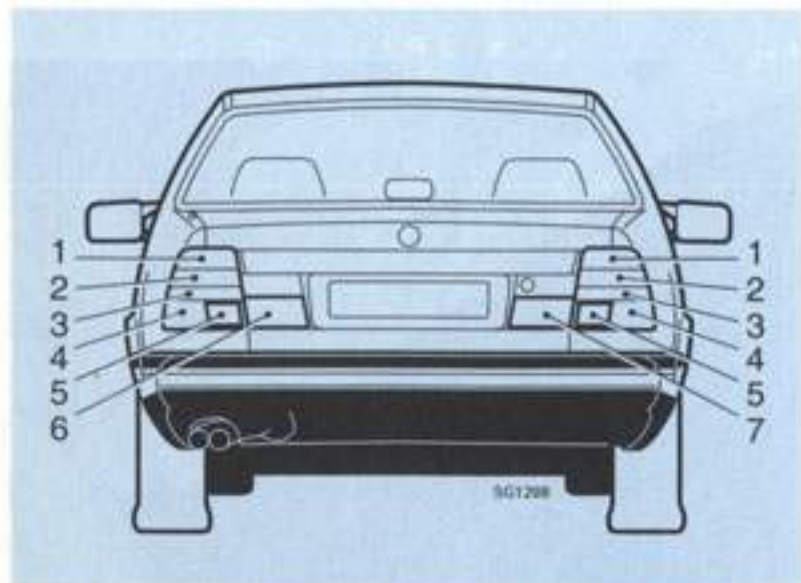

SG1298

Rear light cluster (9000 CS)

Open the access hatch in the trim. Squeeze together the two catches on either side of the lamp holder unit. Carefully withdraw the entire unit from the light fitting. Change the defective bulb.

SG1188

Rear lights (9000 CS)

- 1 Indicator
- 2 Tail light/brake light
- 3 Tail light
- 4 Rear fog light
- 5 Reversing light

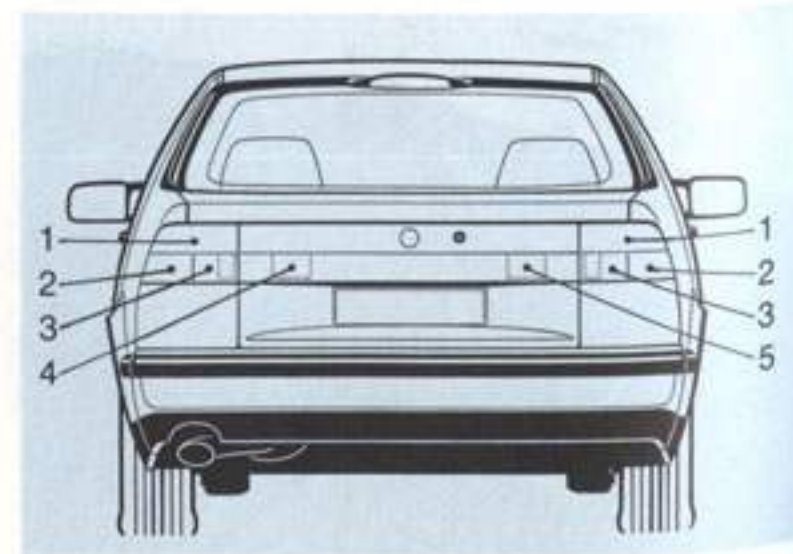

SG1188



Rear lights (9000 CS)

SG1160

- 1 Indicator
- 2 Tail light/brake light
- 3 Tail light

Changing bulbs for reversing light and rear fog light (9000 CS)



SG1161

High-mounted stop light (9000 CD)

The bulb is accessible behind the cover at the back of the light unit. Squeeze the cover at the two ribbed markings and lift it off.

Change the bulb.

High-mounted stop light (9000 CS)

Undo the screws retaining the cover and lamp glass. Change the bulb.



High-mounted stop light (9000 CD)

SG1259

Changing bulb for rear fog light (9000 CD)



SG1300

High-mounted stop light (9000 CS)



SG1159

Side direction indicators

To change side direction indicators, push the glass forwards to release the rear end of the glass and change the bulb. When fitting the glass, make sure that the groove in the metal tongue engages the body sheet.

Door lights, number plate light and luggage compartment light.

Unscrew the glass covering the bulb.

Press back one of the spring contacts and remove the bulb.

Side direction indicator

**Dome light**

Remove the lamp glass from the lamp housing by releasing it at the rear edge. Fit a new bulb.

Cars with sunroof: Release the entire lamp housing by pulling down the front edge. Pull out the lamp housing and fit a new bulb.

Rear-view mirror light

Pull down and remove the glass and change the bulb.

Rear reading lights

Pull out the front of the fitting, prise back the plastic catches to release the bulb holder, pull the bulb holder forward and change the bulb.

Seat belt warning light

Unscrew and remove the surround on the overhead switch panel.

Cars without sunroof: The screw is behind a plastic screw cap.



Cars with sunroof: The screw is behind the cover.

Change the bulb.

Other lights

If other bulbs need changing, we recommend that this be done by your Saab workshop.

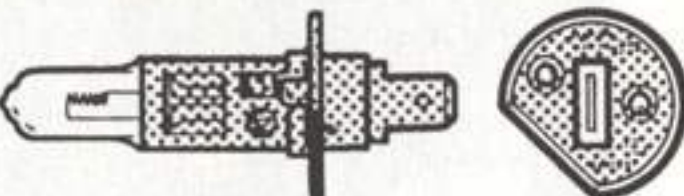
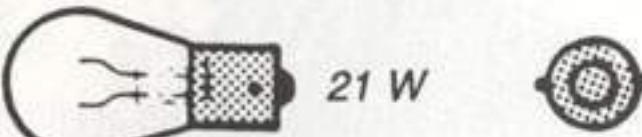
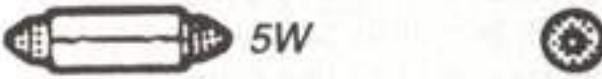
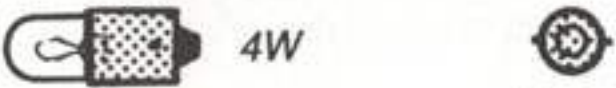
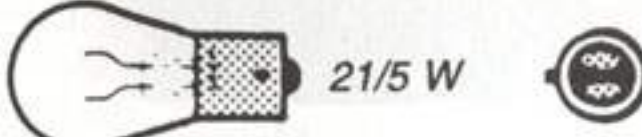
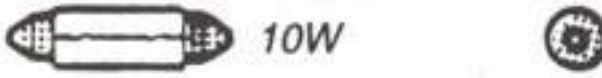
Replacement bulbs

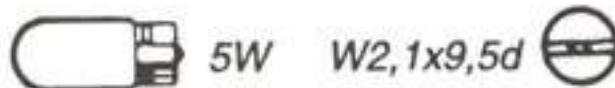
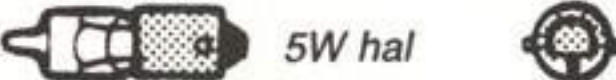
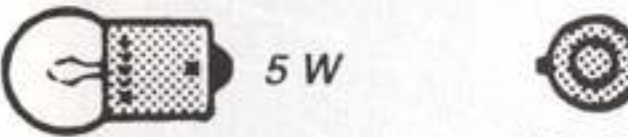
 <p>Headlight 55 W</p> <p>H1 holder</p>	 <p>21 W</p> <p>BA 15s</p> <p>Rear direction indicators (CS), stop lights (CS), reversing lights, rear fog light, high-level stop light (CD)</p>	 <p>5W</p> <p>SV 8,5</p> <p>Number plate illumination, rear-view mirror light, door lights, centre console light, seat belt warning light</p>
 <p>4W</p> <p>Ba 9s</p> <p>Parking lights</p>	 <p>21/5 W</p> <p>BAY 15d</p> <p>Stop light/tail light (CD)</p>	 <p>10W</p> <p>SV 8,5</p> <p>Dome light, luggage compartment light</p>
 <p>1,2W</p> <p>W 2x4,6d</p> <p>Switch illumination, front ashtray</p>	 <p>PY 21W yellow</p> <p>BAU 15s</p> <p>Front and rear direction indicators (CD), front direction indicators (CS)</p>	 <p>5W W2,1x9,5d</p> <p>Side direction indicators, high-level stop light (CS)</p>
 <p>5W hal</p> <p>Rear reading light, reading light on overhead panel</p>	 <p>5 W</p> <p>BA 15s</p> <p>Tail lights</p>	

Fuses

The fuses are housed on three power distribution panels: One inside the glove compartment, one at the front of the engine bay and one (for the ABS system) at the back of the engine bay. In cars equipped with an airbag on the passenger side the main fuse box is located in the lower part of the instrument panel.

A list of the fuses showing the components and circuits they protect is included in the 'Technical Data' section.



Power distribution panel in engine compartment SG1301



Main fuse box (cars with an airbag on the passenger side) SG1268

A special tool (together with spare fuses) for removing fuses is provided in the glove compartment. Push the tool onto the fuse and withdraw it.

Power distribution panel



SG 437

ABS power distribution panel



SG1237

If the wire in the fuse is broken, the fuse has blown. When replacing a fuse, make sure that a fuse of the correct rating (amperage) is used. The fuses are colour coded according to amperage and the rating is also marked on each fuse. If the same fuse blows repeatedly, have the electrical system of the car checked.

⚠ WARNING

Contact your Saab workshop before modifying or connecting any electrical equipment, as incorrect installation can damage or cause fire in the vehicle's electrical system.

Sound fuse / Blown fuse

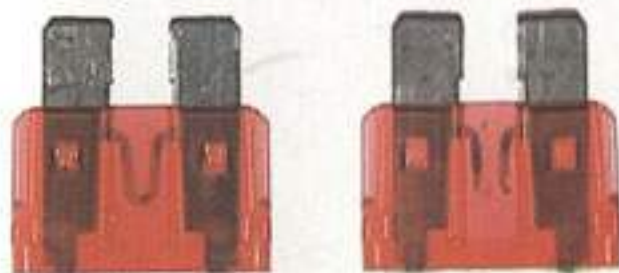

SG 439

Wheels and tyres

Tyres

The tyres and wheels have been carefully designed to match the character of the car and to contribute significantly to its good roadholding characteristics.

If you wish to equip your car with tyres or wheels of a different type than those with which the car was delivered, consult your Saab dealer beforehand about available alternatives.

Tyre designations

As an example, the designation 195/65 R 15 87H on a tyre means:

- 195 - width of the tyre in mm
- 65 - profile ratio between the height and width of the tyre, in per cent
- R - radial ply
- 15 - wheel diameter: 15 inches
- 87 - load code
- H - the tyre is approved for speeds up to a maximum of 130 mph (210 km/h)

Other speed rating codes

- S - tyre approved for 180 km/h max.
- T - tyre approved for 190 km/h max.
- V - tyre approved for 240 km/h max.
- Z - tyre approved for speeds above 240 km/h

Tyre pressures

The tyre pressures should be checked regularly. Inflate the tyres to the recommended pressures for the load to be carried and the normal cruising speed of the car (see the tyre pressure table in the Technical Data Section).

The recommended pressures apply to cold tyres. Never reduce the pressure when the tyres are warm. If warm tyres are being checked, only increase the pressure. Tyres that are incorrectly inflated will wear much more quickly and also greatly reduce the roadholding capabilities of the car.

A leaking tyre valve can readily be changed. Simply unscrew the defective valve and screw in a new one.

N.B. Always remember to adjust the tyre

Tyre wear

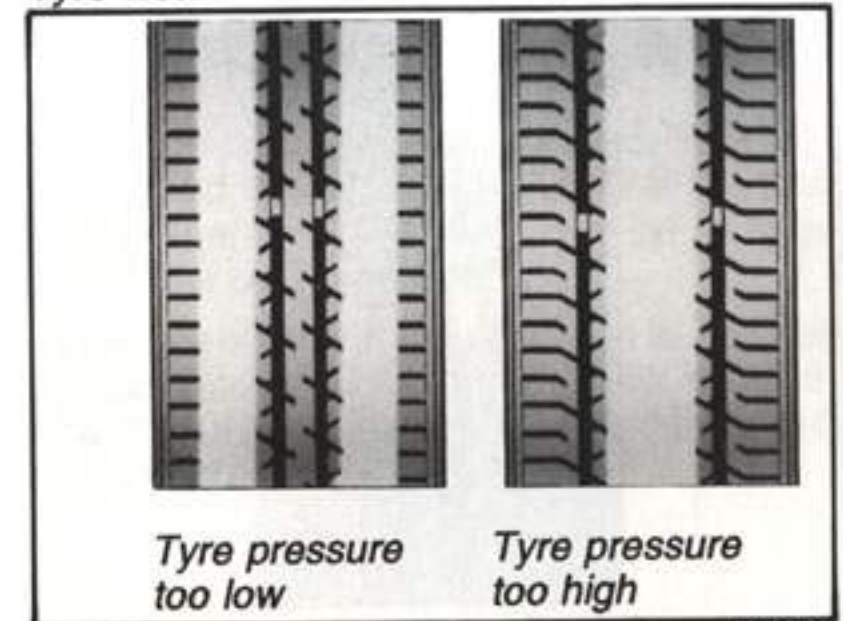

Tyre pressure too low

Tyre pressure too high

SG 839

pressures if the usual load or cruising speed is to be altered substantially.

Wear indicators

The tyres incorporate wear indicators in the form of smooth, treadless strips running across the width, which become visible when only 1.6 mm of the tread remains. As soon as the wear indicator becomes visible, the tyre should be replaced.

Make sure that you are familiar with national regulations on tread depth and what types of winter tyres are permitted.

Wear indicators

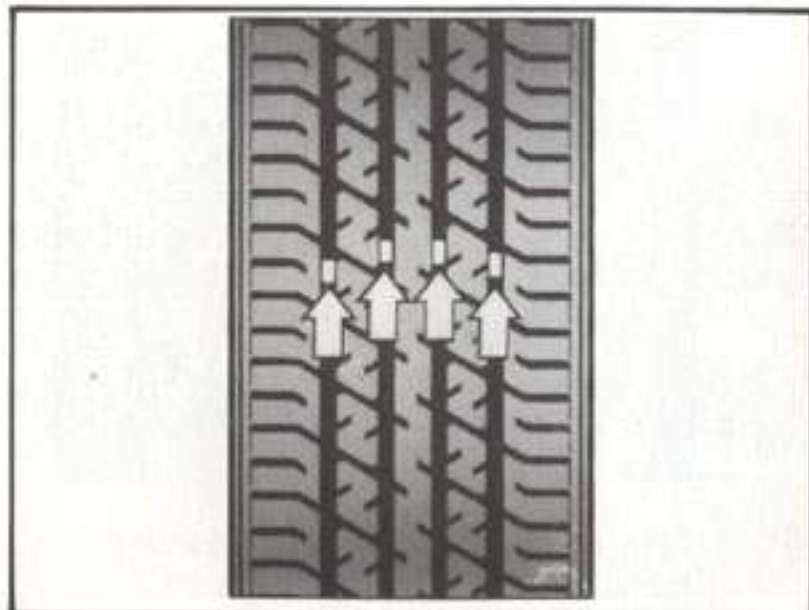

SG 840

Changing the wheels

The spare wheel, warning triangle and jack with crank are stored beneath a panel in the luggage compartment floor. The raised panel can be hooked open by means of the rubber strap attached to the parcel shelf bracket on the right-hand side. The car tool kit is secured to a panel in the side trim on the right-hand side of the luggage compartment.

To jack up the car, insert the jack in one of the jacking points underneath the sills (two on either side). If a trolley jack is used, this must be applied either to the reinforced subframe for the engine or under the reinforced member adjacent to the rear tow-rop eye.

Never apply the jack to the rear axle.

⚠ WARNING

- The jack supplied with the car is for wheel changing in the event of a puncture and for fitting snow chains only and not for regular maintenance work.
- Never crawl under the car when it is supported by the jack alone.
- Take particular care when using the jack if the car is on a hill or cambered road surface. NOTE: use chocks as an extra safety precaution.
- Place the chocks in front of and behind the wheel diagonally opposite the one to be changed.

- Switch on the hazard flashers when wheel changing at the roadside.
- Apply the handbrake and engage 1st gear or reverse on cars with a manual gearbox, or select position P on cars with automatic transmission.
- Never jack up the car with people inside.
- Never start the engine when the car is jacked up.
- Make sure that the jack is placed on firm, level ground, never on manhole covers, metal gratings and the like.

Panel secured in raised position



SG1232

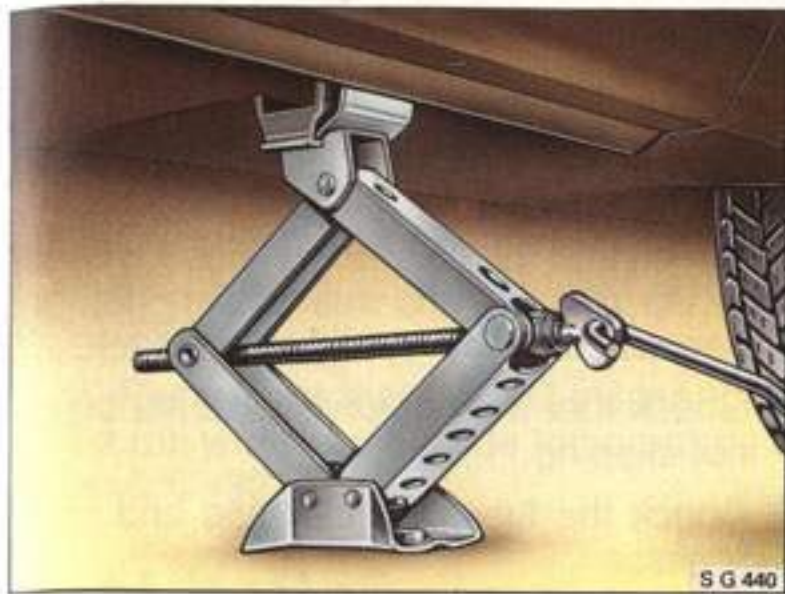

Correct position of jack

SG 440



Removing the hub cap

SG1146



Tightening sequence for wheel studs

SG1147

- Stow the jack correctly in the place provided for it under the panel in the floor of the luggage compartment. Do not leave it loose in the luggage compartment as it could injure the car occupants in the event of a collision.
- It is always dangerous to crawl under the car when it is jacked up, even if stands are used.
- The jack supplied should be used only with your Saab car.

- 1 Apply the handbrake. Insert the jack. Wind the jack down and check that the flange at the top of the jack fits snugly against the sill and that the entire foot is in contact with the ground.
- 2 Remove the hub cap by carefully prising it off with a screwdriver. Note that the wheel wrench can be used to re-

lease the clamp for the spare wheel. Slacken the wheel studs half a turn.

- 3 Wind the jack up until the wheel is clear of the ground. Undo the wheel studs and remove the wheel.
- 4 Fit the wheel leaving the wheel studs slack. Make sure that the wheel and studs are correctly aligned.
- 5 Lower the car. Tighten the wheel studs in the sequence shown using the wheel wrench included in the car tool kit. Tightening torque: 105-125 Nm. Never overtighten the studs by using a percussion nut tightener as it may not be possible to undo them using the car wheel wrench.
Note: when refitting the wheel cover after changing a wheel, make sure that the air valve fits in the wheel cover's aperture.

- 6 Retighten the studs after 20-50 miles. Tightening torque: 105-125 Nm.

Compact spare wheel

The compact spare wheel (115/70 R16) is designed for ease of handling at the roadside when a wheel needs to be changed because of a puncture.

The wheel should only be used in an emergency and, with the spare wheel fitted, the car should not be driven further than 2100 miles (3500 km).

⚠ WARNING

Do not exceed a speed of 50 mph (80km/h) as this may cause overheating of the tyre and deterioration of the road behaviour.

The tyre pressure on the spare wheel should be 4.2 bar (60 psi).

Place the wheel that has been removed inside the plastic bag provided.

Change back to the ordinary wheel as soon as possible.

Flat spots

All tyres become hot when driving, especially on long journeys or during hard driving. When the car is parked after this type of driving and the tyres cool, they may get a so-called flat spot. This means that the surface of the tyre against the ground becomes somewhat flattened which can lead to steering wheel vibration similar to tyre imbalance. The flat spot disappears when the tyres warm up again after 20-25 km driving at out-of-town speeds.

Air conditioning (AC)

IMPORTANT

All repair and adjustment work on the AC system must be carried out by an authorized Saab garage having the necessary personnel and equipment for such work. Special tools and a special purging procedure are required for R134a refrigerant. Never mix R134a and R12 refrigerants.

⚠ WARNING

The AC system is pressurized. Do not loosen or undo any connections in the AC system as the outflowing gas could cause blindness or other injury.

Fault diagnosis

If a malfunction should occur in the air conditioning system, you can carry out the following checks yourself. If the fault persists, take the car to an authorized Saab workshop.

Note: When the air-conditioning system is running, condensate will form on the evaporator. When the car is parked, this condensate may drip off and form a small pool of water under the car.

Inadequate cooling capacity

- Check that the temperature and air distribution controls are set to the correct positions.
- Check that the condenser (fitted forward of the radiator and intercooler) has not become clogged by dirt and insects.
- Check that the compressor drive belt is not slipping.
- Check the fuses for the fans and compressor.

Maintenance and servicing

- The car should be taken to an authorized Saab workshop once a year for servicing of the air conditioning system.
- Check the compressor drive belt at every regular service.
- The condenser and radiator must be kept clear of insects and other dirt. When washing the car, use the hose to spray the radiator and condenser to flush away any dirt and foreign bodies, spraying through the grille at the front of the car and from inside the engine compartment. Do not use high-pressure water.
Do not use a hose when the engine is hot.

Never place a fine-mesh net or any other form of screening in front of the radiator as this will drastically reduce its cooling capacity.

- During the winter months when the AC system (applies to manual heating and

ventilation system) is not being used, it should be run for between five and ten minutes once or twice a month after the engine has warmed up. This is to prevent deterioration of the gaskets and seals in the compressor which are lubricated by means of a lubricant circulated with the refrigerant.

Note. Remember that the AC system cannot be run when the outside temperature is below 0°C (32°F).

Seat belts

Check periodically that the seat belts are working properly. A sharp tug on the strap should cause the inertia reel to lock. Check the floor anchorage points to ensure that they have not been weakened by corrosion. If the belt is worn or has any fraying edges, it should be replaced.

WARNING

Seat belts and belt pretensioners that have been exposed to severe loads such as those occurring in a collision must always be changed, regardless of whether or not they are visibly damaged.

Never carry out any belt repairs yourself or attempt to modify the function of the belts.

The belts must not come into contact with substances such as polishes, oil or chemicals. If the straps get dirty, wash them with soap and warm water or have them replaced.

Upholstery and trim

To remove fluff or hairs from the seat upholstery or headlining, use a moist, lint-free cloth or a special fluff-removing roller. Remove any dirty marks using a cloth moistened with lukewarm soapy water.

When using a stain remover to remove dirty marks, always work from the outside towards the centre to avoid leaving a ring. However, if a dirty ring or a spot of dirt should remain, this can usually be removed using warm soapy water or water alone.

Wet patches caused by spilt soft drink or thin oil must be wiped off immediately using an absorbent material, such as kitchen paper. Then treat the patch with stain remover.

White spirit is recommended for removing grease or oil stains. Plastic trim may be washed with warm water and a synthetic detergent. A semi-stiff brush may also be used.

Woollen materials

Woollen upholstery should be cleaned and looked after just like other fabric upholstery, but note the following:
Avoid severe mechanical treatment such

as stiff brushes and vacuum cleaners, as this in conjunction with moisture and heat can lead to the upholstery becoming fluffy.

Cleaning and caring for leather upholstery

Leather upholstery should be treated principally to enhance the elegant appearance, but also to protect the surface. Wear and dirt may very well discolour leather, particularly the lighter shades. Although this does not affect the wear properties - a wear patina is often desirable on a leather surface - a surface which is too dirty may impair the visual quality.

The leather upholstery should be cleaned and reconditioned when the car is inspected in the spring and autumn (twice a year).

Moisten a soft cloth in a mild soap solution. Carefully apply this damp (not wet) cloth to the leather with light, circular movements until the leather is clean. Repeat this procedure using clean water. Let the leather dry completely. Then apply Saab Leather Cleaner - a leather conditioner which can be purchased from authorized Saab dealers.

Apply the leather conditioner with the same circular movements as described above. Use a soft cloth. Let the leather conditioner dry and polish the leather with a soft, dry cloth. Follow the instructions given above. Do not use hot water, unknown abrasive polishes, solvents, sprays or soaps that

may scratch the leather. This treatment will keep the leather upholstery clean and attractive for many years.

Textile carpeting

The textile carpet should be vacuum cleaned regularly. The carpet may also be cleaned using a brush or carpet shampoo applied with a sponge. Before using a vacuum cleaner, make sure that it is properly earthed.

Engine compartment

Clean the engine compartment using an engine detergent and rinse with hot water. Cover the headlights and avoid spraying the radiator, throttle cable and other engine controls, the alternator and other electrical components, particularly if using a high-pressure hose.

If using a high-pressure hose, the nozzle should be directed at 90° to the surface being washed. This is especially important where there are labels.

Do not use petrol (gasoline) when carrying out repairs or maintenance work. An environment-friendly degreasing agent is more suitable.

Waxing and polishing

A new car should not be waxed before three or four months. The bodywork will not need polishing before the paint has oxidized and become dull. Abrasive polishes containing a cutting agent should only be used in exceptional cases on a new car. Before waxing or polishing, make sure that the paintwork has been thoroughly cleaned.

Washing the car

Wash the car frequently. When the car is new, wash the body by hand using cold water and a brush attachment on the end of a hose. During the first five or six months, before the paintwork has hardened properly, avoid automatic car washes. Thereafter use a car shampoo added to lukewarm water.

Bird droppings should be washed off as soon as possible because they may cause discoloration which is difficult to remove by polishing.

Road tar can be removed with a cloth moistened with white spirit. Avoid strong cleaning agents, since these may dry out the paint. Tar solvents should not be used to wash the front and rear light cluster lenses, since they may cause cracking of the lenses.

The underbody also needs washing regularly, and this should be done extra thoroughly at the end of winter. Clean the underbody thoroughly by hand if the car is usually washed in an automatic car wash without special facilities for underbody cleaning.

Never wash or allow the car to dry in the sun but wipe it dry with a leather immediately after washing to avoid smears and streaks.

Clean the window glass inside and out using a proprietary window cleaner. This is particularly important when the car is new, as the upholstery and trim may have a slight tendency to sweat at first.

IMPORTANT

Check that the brakes are working properly after the car has been washed.

Lower the electric aerials by switching off the radio before entering an automatic car wash.

Clean the aerial with a soft cloth and then lubricate lightly with an oily piece of cloth.

Fixed aerials must be removed.

Touching-up the paintwork

Damaged paintwork should be treated as soon as it is discovered. The sooner it is treated the less will be the risk of corrosion starting.

Damage to paintwork after the car has been involved in a collision is usually extensive and can only be properly restored by professionals.

However, you can deal yourself with chips in the paintwork caused by stones thrown up from the road as well as minor scratches. The necessary tools and materials, such as brushes, touch-up paint and primer, are available from your Saab dealer.

In the case of minor flaws in the paintwork, where the metal has not been exposed and an undamaged layer of paint remains, touch-up paint can usually be applied direct after any dirt has been scraped away with a knife-point.

If the metal has been exposed and corrosion has started, all surface rust must be scraped off using a knife-point. If possible, the entire damaged area should be scraped to the bare metal. The metal should then be primed with two thin coats of primer applied with a brush.

The top coat should then be applied in several thin layers until the surface of the dam-

aged area is level with the surrounding paintwork.

The primer and touch-up paint must both be stirred thoroughly before use. Allow each coat of paint to dry before applying the next coat.

Two-coat paint

As the name implies, two-coat paint is applied in two operations. The first coat - the base paint - contains the pigment - metal flakes and binder. The second coat consists of a clear varnish which provides the final gloss for the paintwork and protects the base paint from moisture and environmental pollutants.

To touch-up paintwork chipped by stones, proceed as follows: Thoroughly clean the area and then apply the primer, base paint and finally the clear varnish. To achieve the best finish, apply the primer in two or three coats.

Anti-corrosion treatment

The entire car is corrosion-protected at the factory in different stages with electrolytic paint, primer, a polyester-based protective coating against stones flung up by the wheels and thin penetrating anti-rust oil in cavities and body members.

Some metal bodywork parts are partly galvanized.

The anti-corrosion treatment on the underside of the car and inside the wheel arches is particularly exposed to wear and possible damage, the degree of which will obviously depend on driving conditions. Dirt and, more especially, salt thrown up from the road can then initiate corrosion.

It is therefore advisable to make a habit of hosing down the underbody and checking the anti-corrosion treatment. Even while the car is covered by the corrosion warranty, you are still responsible for having the maintained normally, which includes touching-up any damage.

After the underbody has been hosed clean and allowed to dry, apply viscous anti-corrosion oil to any worn or damaged areas, using a spray applicator or paintbrush.

Even after the corrosion warranty has expired, it is in your own interest to maintain the anti-corrosion treatment and assure your car of long-term protection.

Seams in the body and doors are particularly vulnerable to the onset of external corrosion caused by dirt and road salt and on the inside by moisture not least condensate. Keep the seams clean and, at the first sign of corrosion, treat the affected area with a thin anti-corrosion oil by means of a spray applicator or brush. If necessary, consult your Saab workshop.

Service Programme

Australia only: This vehicle conforms to the Australian Exhaust Emission Control Regulations ADR37/00 applicable to 1993 new motor vehicles. Servicing of the emission control system should be carried out by an authorized Saab dealer.

Every car needs regular servicing and maintenance if it is to provide trouble-free motoring. A Service Programme has been drawn up for your car, and this includes specifications of work that should be carried out at given intervals. Service Book contains the information about the Service Programme. The Warranty Conditions specify that the prescribed services and oil changes must be carried out at the stated intervals by an authorized Saab workshop.

To ensure that your car is properly serviced and to keep servicing costs to a minimum, the "Saab Original Service" programme includes preventive maintenance to avert possible malfunctions and to maintain a high standard of safety. The service also includes work necessary to ensure compliance with the relevant exhaust emission regulations.

Have your Service Book with you when you hand over your car for a service, and when collecting your car, make sure that all of the items specified in the programme have been carried out and that the Service Book has been stamped in the correct place. A valid stamped Service Book is not only an assurance of reliability and motoring econ-

omy but also adds to the trade-in or second-hand value of the car.

The scope and content of the Service Programme may be changed from time to time but your authorized Saab workshop will always have up-to-date details of any changes affecting your car.

Motoring abroad

Before setting off on a long journey it is advisable to have your car checked over at an authorized Saab garage.

Obtain a few important items to take along on your journey, such as spare bulbs, wiper blades, fuses, a multigroove drivebelt, etc. You can check some points yourself beforehand:

- Make sure that the engine is in good condition.
- Check that no oil or petrol leaks out of the engine and gearbox.
- Inspect the multigroove drive-belt and change it if it shows signs of hard wear.
- Check the condition of the battery and its charge.
- Inspect the tread pattern and check the inflation pressures of the tyres, not forgetting the spare.
- Make sure that the maximum permitted speed for the vehicle's tyres is not exceeded in countries with no speed limit.

For speed rating, see section headed "Wheels and tyres".

- Check the brakes.
- Check all bulbs.
- Check the tool kit.
- Make sure there is a warning triangle in the car and that you are familiar with the law concerning its use in the countries you will be visiting.
- When driving from a country with left-hand traffic to a country with right-hand traffic or vice versa, cover over with black tape that part of the headlamps giving an asymmetric dipped beam. Otherwise you will dazzle oncoming traffic.
- Consult your Saab garage if you intend to drive in countries where unleaded petrol or petrol with a sufficiently high octane rating is not available. The garage must then make certain adjustments to the engine.

Taping headlamp glass for driving in countries with left-hand drive

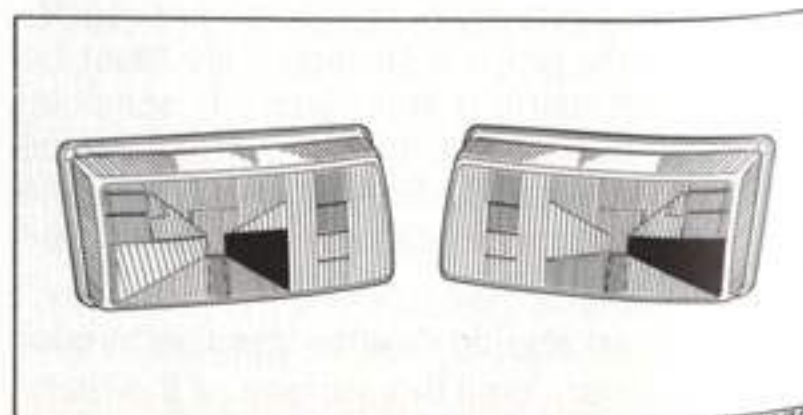



Technical data

General	106
Engine	108
Electrical system	110
Fuses	110
Gearbox	112
Suspension	113
Brakes	113
Steering	113
Wheels and tyres	113
Car identification	114

General

Overall length, incl. bumpers	
9000 CS _____	4761 mm
9000 CD _____	4780 mm
Overall width _____	1778-1806 mm
Overall height _____	1420 mm
Wheelbase _____	2672 mm
Ground clearance (car carrying 3 adults + 1 child with combined weight of 240 kg)	
9000 CD _____	155 mm
9000 CS _____	159 mm
9000 CS Aero _____	154 mm
Track between front wheels (7J x 15) _____	1538 mm
Track between front wheels (6 1/2 J x 16) _____	1534 mm
Track between front wheels (6J x 15) _____	1522 mm
Track between front wheels (5 1/2J x 15) _____	1510 mm
Track between rear wheels (7J x 15) _____	1508 mm
Track between rear wheels (6 1/2 J x 16) _____	1504 mm
Track between rear wheels (6J x 15) _____	1492 mm
Track between rear wheels (5 1/2J x 15) _____	1480 mm
Turning circle,(measured kerb to kerb) _____	10.9 m
Turning circle,(measured wall to wall) _____	11.9 m
Number of seats (incl. driver) _____	5
Washer fluid reservoir capacity _____	4.1 litres

Gross weight

*Max. train weight
(= gross weight + max.
trailer weight)*

Max. axle load, front

Max. axle load, rear



Permitted load (in addition to driver) = gross weight - kerb weight
Note that the maximum permitted axle load, front and rear, must not be exceeded. The exact kerb weight (unladen weight + 70 kg driver) and load capacity are set out in the registration documents.

Chassis number plate in engine compartment

Weight, ready for driving (includes full tank, washer fluid, tools and spare wheel)

9000 CD _____	1345 -1475 kg
9000 CS _____	1360-1485 kg
9000 CS Aero _____	1440-1500 kg
Gross weight	
9000 CD _____	1890 -1940 kg
9000 CS _____	1920-1960 kg
9000 CS Aero _____	1940-1960 kg
Max. axle load	
Front _____	1060 kg
Rear _____	980 kg

Weight distribution:

Kerb weight, front/rear _____	60/40 %
Gross weight, front/rear _____	50/50 %
Max. permitted load on roof _____	100 kg
Max. permitted trailer weight	
Trailer with brakes (9000 CD) _____	1600 kg
Trailer with brakes (9000 CS) _____	1800 kg
Trailer without brakes _____	750 kg
Max. tow ball load _____	75 kg

Volume of luggage compartment,

Saab 9000 CS (SAE):

with parcel shelf _____	448 dm ³
with rear seat folded _____	1183 dm ³

Maximum permissible load in luggage compartment:

At curb weight with 4 passengers having combined weight of 280 kg _____	100 kg
---	--------

Length of luggage compartment:

Rear seat folded _____	1670 mm
Rear seat upright _____	1010 mm

Boot of 9000 CD:

Volume (SAE) _____	503 dm ³
--------------------	---------------------

Maximum permissible load in boot:

At curb weight with 4 passengers having combined weight of 280 kg _____	80 kg
---	-------

Length of boot _____	1110 mm
----------------------	---------

 **WARNING**

- Permitted gross weight and axle load must never be exceeded.
- When carrying a load, always make sure it is securely fastened. This is especially important if the car is used with the rear seat folded forward.

Engine**Engine type**

2.0 and 2.3 litre engines _____ 4 cylinder, 4 stroke
with 2 overhead
camshafts and
16 valves

3.0 litre engine V6 _____ 6 cylinders with 4
overhead camshafts
and 24 valves

Cylinder bore

2.0 and 2.3 litre engines _____ 90 mm

3.0 litre engine _____ 86 mm

Stroke length

2.0 litre engine _____ 78 mm

2.3 litre engine _____ 90 mm

3.0 litre engine _____ 85 mm

Swept volume

2.0 litre engine _____ 1.985 dm³

2.3 litre engine _____ 2.290 dm³

3.0 litre engine _____ 2.962 dm³

Idling speed

2.0 and 2.3 litre engines _____ 800-900 rpm

3.0 litre engine _____ 670-830 rpm

Fuel tank capacity

_____ 66 litres

Fuel

_____ lead-free
9000 CS, 9000 CD _____ recommended 95
RON, min 91 RON

9000 CS Aero _____ recommended 98
RON, min 91 RON

Grade of oil:

Saab Turbo Engine Oil or an oil which meets the requirements of API Service SG and CCMC G4 or G5. Oil of the above grades contains additives suitable for the engine.

We advise against the use of other additives.

Viscosity:

10W/30, 10W/40, 5W/30 or 5W/40.

If these grades are not available, oil of viscosity 15W/40 may be used, but not in winter.

If 5W grade oil is used it must be of synthetic or semi-synthetic type.

For areas with temperatures not below +15-20 °C 15W/50 or 20W/50 oil grades can be recommended.

Oil capacity, incl. filter (for oil change)

2.0 l engine _____ 5.0 litres

2.3 l engine _____ 5.0 litres

3.0 litre engine _____ 4.5 litres

Anti-freeze _____ Saab approved
anti-freeze

Fluid volume, cooling system

4 cylinder engine _____ 9.0 litres

3.0 V6 _____ 8.0 litres

Fuel injection engine (2.0 l):

Rating (EEC) at 5500 r/min _____	130 bhp (96 kW)
Torque (EEC) at 4300 r/min _____	177 Nm (18.0 kgfm)
Compression ratio _____	10.1:1

Turbo engine (2.0S):

Rating (EEC) at 5500 r/min _____	150 bhp (110 kW)
Torque (EEC) at 2500 r/min _____	210 Nm (21.4 kgfm)
Compression ratio _____	8.8:1

Turbo engine (2.0 l):

Rating (EEC) at 5500 r/min _____	185 bhp (136 kW)
Torque (EEC) at 2100 r/min _____	283 Nm (28.8 kgfm)
Compression ratio _____	9.2:1

Fuel injection engine (2.3 l):

Rating (EEC) at 5600 r/min _____	147 bhp (108 kW)
Torque (EEC) at 3800 r/min _____	205 Nm (20.9 kgfm)
Compression ratio _____	10.5:1

Turbo engine (2.3S):

Rating (EEC) at 5700 r/min _____	170 bhp (125 kW)
Torque (EEC) at 3200 r/min _____	260 Nm (26.5 kgfm)
Compression ratio _____	9.25:1

Turbo engine (2.3 l):

Rating (EEC) at 5500 r/min _____	200 bhp (147 kW)
Torque (EEC) at 1800 r/min _____	323 Nm (32.9 kgfm)
Compression ratio _____	9.25:1

Turbo engine (2.3 l Aero)

Rating (EEC) at 5500 r/min _____	225 bhp (165 kW)
Torque (EEC) at 1800 r/min _____	342 Nm (34.9 kgfm)
Compression ratio _____	9.25:1

Fuel injection engine (3.0 litre V6):

Rating (EEC) at 6200 rpm _____	210 bhp (155 kW)
Torque (EEC) at 3300 rpm _____	270 Nm (27.5 kgfm)
Compression ratio _____	10.8:1

Electrical system

Voltage _____	12 V
Battery capacity _____	60 Ah
Starter motor _____	1.4 kW
Alternator rating, max. charging current/voltage	
4 cylinder engine _____	90 A or 110 A/14V
3.0 V6 engine _____	120 A/14 V
Firing order	
4 cylinder engine _____	1-3-4-2
3.0 V6 engine _____	1-2-3-4-5-6
Sparkplugs,	
4 cylinder injection engine _____	NGK BCPR 6ES
Turbo _____	NGK BCPR 7ES
3.0 V6 engine _____	Bosch FR8 LDC (normal driving) Bosch FR7 LDC (hard driving)
Electrode gap	
4 cylinder engine _____	1.0 mm (+0.1/-0.2)
3.0 V6 engine _____	0.8 mm

Drive belts

Engine type	external length
9000 2.0 alternator belt (poly-V) _____	1592 mm
9000 2.0 belt for A/C compressor _____	1252 mm
9000 2.3 without A/C compressor (poly-V) _____	2317 mm
9000 2.3 with A/C compressor (poly-V) _____	2553 mm
9000 3.0 V6 without A/C compressor _____	1900 mm
9000 3.0 V6 with A/C compressor _____	2287 mm

Fuses and relays

1	4	7	10	13	16	19	22				
2	5	8	11	14	17	20	23	25	27	29	31
3	6	9	12	15	18	21	24	26	28	30	32

S G 407

Arrangement of fuses on panel at back of glove compartment

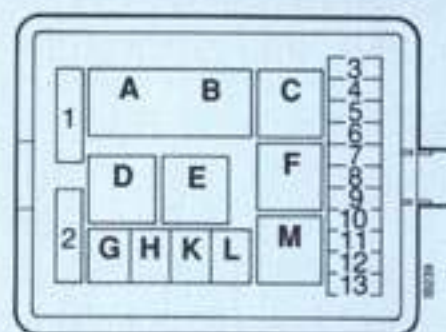

Arrangement of fuses/relays on panel in engine compartment

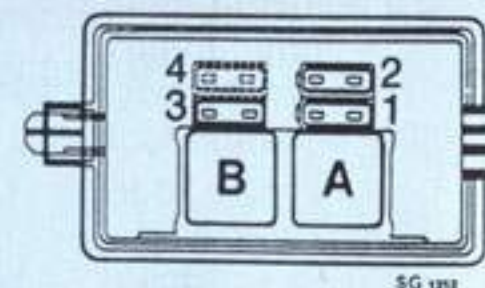

S G 1282

ABS fuse and relay panel

Fuse	Function	Rating (A)
<i>Distribution box in glove compartment</i>		
1	A/C; ACC _____	5
2	Cruise control system; electric door mirrors _____	10
3	Belt warning; reading lights _____	10
4	Airbag _____	5
5	APC system; water pump (V6) _____	10
6	Ventilation fan _____	30
7	Headlamp wipers _____	10
8	Windscreen wipers, rear windscreen wipers _____	20

Fuse	Function	Rating (A)	Fuse	Function	Rating (A)
9	Reversing lights; rear electric windows; sunroof	30		<u>Distribution box in engine compartment</u>	
10	Heated seats	20	1	Air pump	30 (max)
11	Front electric windows; relay reduced low beam (driving lights)	30	2	Radiator fan, 2 step	30 (max)
12	Indicators, beam length control	15	3	Radiator fan, relay	5
13	Instrument; EDU; injection system	10	4	Radiator fan (standard)	40
14	Fuel pump	20	5	Dipped beam L	15
15	Electronic throttle (cars with TCS)	5	6	Dipped beam R	15
16	Central lock; interior lighting; courtesy lights; boot lighting; relay reversing light	15	7	High beam L	15
17	ACC, EDU	10	8	High beam R	15
18	Heated rear windscreen	30	9	Relay, horn	5
19	Radio; electric aerial; clock; SCC	15	10	Horn	25
20	Option	max 20	11	A/C radiator fan/compressor	30
21	Horn; electronic throttle (cars with TCS); TCS (V6)	25	12	Extra lamp	15
22	Hazard warning lights	15	13	Valve, air pump	10
23	Engine electronics, test outlet	5	A-B	Light relay	
24	Brake lights	15	C	Lamp test (pictogram)	
25	Electrically adjustable seat, driver	30	D	Air pump	
26	Electrically adjustable seat, passenger	30	E	Radiator fan, 2 step	
27	Radio	10	F	A/C relay	
28	Pre-heated Lambda probe	10	G	Extra light-fog light	
29	Parking light R; rheostat instrument lighting	15	H	Pressure monitor A/C	
30	Parking light L, glove compartment lighting	10	K	Reduced low beam (driving light)	
31	Driving lights	15	L	Horn	
32	Rear fog light	15	M	Radiator fan	
				<u>ABS power distribution panel</u>	
			1	ABS pump	30
			2	ABS	30
			3	Pump and control unit, ABS	10
			4	Spare	-
			A	Pump relay	
			B	System relay	

Manual gearbox

Type _____	5-speed all-synchromesh with integral final drive and differential
Gearbox oil (for topping up) _____	Engine oil to API Service SF/CC or SF/CD, SAE 10W/30 or 10W/40 Middle East-market only: SHPD B.P. Vanellus F.E. 10W30 or 15W40
Oil capacity _____	2.5 litres
Hydraulic clutch type _____	Single dry-plate clutch of diaphragmspring type
Speed in 5th gear (km/h) at 1000 rpm	
2.0i, 2.3i, 2.0S _____	37
2.0 Turbo _____	41
2.3S, 2.3 Turbo _____	45-46
3.0 V6 _____	41

Automatic transmission

Type _____	4-speed gearbox with torque converter, final drive and differential
Selector lever positions _____	PRND321
Fluid capacity (incl. torque converter and oil cooler) _____	8.4 litres
When changing the oil, about 3.3 litres can be drained via the oil filter cover and oil filter (3 bolts) and drain plug on the final drive housing.	
.Grade of fluid _____	Dexron 2 ATF Middle East-market only: ATF Dexron 2E
Clutch type _____	Hydraulically-operated plate clutches, brake bands and one-way couplings
Speed in 4th gear (km/h) at 1000 rpm	
2.0i, 2.3i _____	37
2.0S, 2.0 Turbo _____	40-41
2.3S, 2.3 Turbo _____	40-41
3.0 V6 _____	43-44

Suspension

Spring type, front and rear _____ Coil springs
 Maximum deflection of springs:
 Front _____ 185 mm
 Rear _____ 210 mm
 Dampers, front and rear _____ Gas-filled telescopic dampers

Brakes

Footbrake (ABS) _____ Hydraulic disc brakes with vacuum servo, 2 circuit diagonal system, (3 circuit system on 9000 Aero with TCS), ventilated discs on front wheels
 Handbrake _____ Acts on rear-wheel discs
 Brake fluid _____ To DOT 4
 Outer working diameters of discs:
 Front _____ 278 mm
 Rear _____ 256 mm
 Total friction area of brake pads:
 Front _____ 192 cm²
 Rear _____ 72 cm²

Steering

Steering system _____ Power-assisted steering of rack-and-pinion type with telescopic, jointed steering column shaft
 Number of turns lock-to-lock _____ 3.2
 Power steering fluid _____ "Saab Power Steering Fluid 1890"

Wheels and tyres

Wheel sizes _____ 6 J X 15" H2 or 6 1/2 J X 16" H2
 Compact spare wheel _____ 3.50 B X 16 H2
 Spare wheel 175/70 R 15 (option) _____ 5 1/2 J x 15" H2

Tyre sizes

Please note that some variations in tyre sizes can occur due to different optional or accessory wheels having been fitted

9000 CS/CSE
 2.0S, 2.0i, 2.3i _____ 195/65 VR 15
 2.0T, 2.3S, 2.3T, 3.0 V6 _____ 205/60 ZR 15
 2.0T, 2.3T(option), Aero _____ 205/55 ZR 16
 9000 CD/CDE
 All variants _____ 195/65 VR 15

Compact spare wheel:

Size _____ T115/70 R16

Tyre pressure _____	4.2 bar (60 psi)
Maximum mileage _____	2100 miles (3500 km)
Maximum speed _____	50 mph (80 km/h)
Spare wheel 175/70 R 15 T(option)	
Tyre pressure _____	2.5 bar (36 psi)
Maximum speed _____	50 mph (80 km/h)
Winter-tyre size (with 5 1/2 J X 15" H2 wheel) _____	
	185/65 R15 MS
Winter-tyre size (with 6 J X 15" H2 wheel) _____	
	195/65 R15 MS
Front wheel alignment:	
Toe-in measured between rims _____	1.5 ± 0.5 mm

Car identification

To identify the precise model of your car, it will help the Saab dealer if you quote the chassis number, engine number or gearbox number (see next page).

Australia only: The chassis number plate in the engine compartment also includes building year and month (above chassis No.).

Recommended tyre pressures, cold tyres

Tyres size	Load/speed (mph)	Front bar/psi	Rear bar/psi
195/65 R 15T	1-3 occupants/0-100	2,1/30	2,1/30
	Max load/0-100	2,1/30	2,1/30
	Max load/100-200	2,3/33	2,3/33
195/65 VR15	1-3 occupants/0-100	2,1/30	2,1/30
	Max load/0-100	2,1/30	2,1/30
	Max load/100—	2,6/38	2,6/38
205/60 ZR15	1-3 occupants/0-120	2,2/32	2,2/32
	Max load/0-120	2,2/32	2,2/32
	Max load/120—	2,7/39	2,7/39
205/55 ZR16	1-3 occupants/0-120	2,4/35	2,4/35
	Max load/0-120	2,4/35	2,4/35
	Max load/120—	2,8/41	2,8/41
185/65 R15T M+S (Winter tyre M+S)	1-3 occupants/0-100	2,3/33	2,3/33
	Max load/0-100	2,5/36	2,5/36
	Max load/100-120	2,7/39	2,7/39
195/65 R15T M+S (Winter tyre M+S)	1-3 occupants/0-100	2,3/33	2,3/33
	Max load/0-100	2,5/36	2,5/36
205/50 R16H M+S (Winter tyre M+S)	1-3 occupants/0-100	2,3/33	2,3/33
	Max load/0-100	2,5/36	2,5/36
	Max load/100-130	2,9/42	2,9/42

Reduce the pressure by 0.1 bar for each reduction in the number of occupants. Max load = 5 occupants and maximum load in luggage compartment.



Chassis number plate
Body and trim colour plate

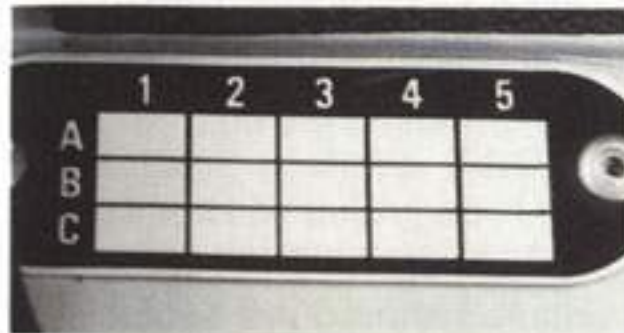

Marking plate for modification work



Gearbox number (manual gearbox)

SG 450

SG 454



BODY COLOUR 196
TRIM COLOUR F23
SAAB

SG1136

Chassis number

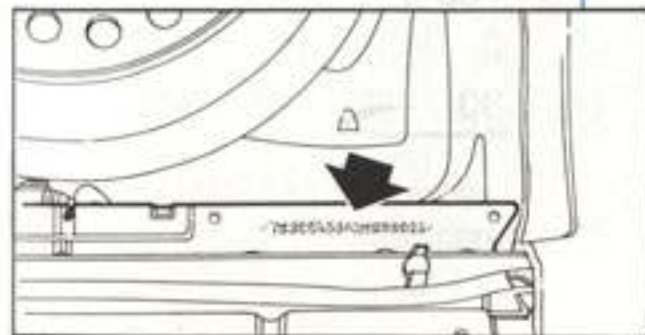

SG1260

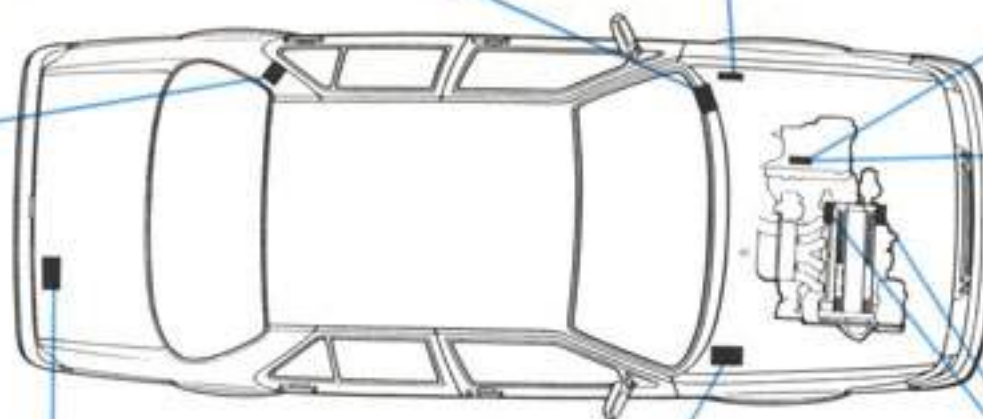

Chassis number plate

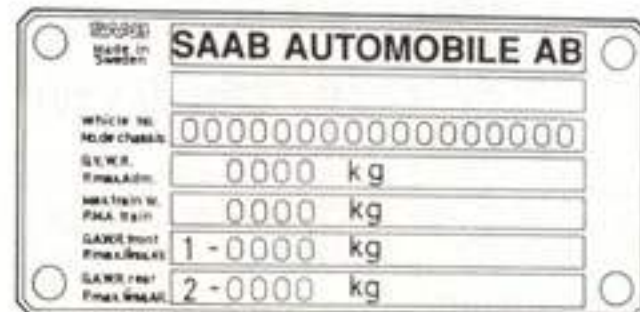

SG1144

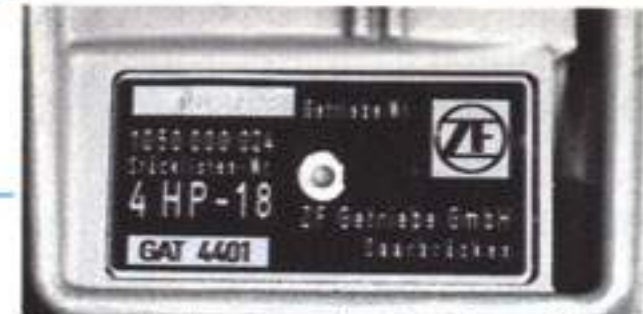

Transmission number (automatic transmission)

SG 657

Engine number stamped on the engine block

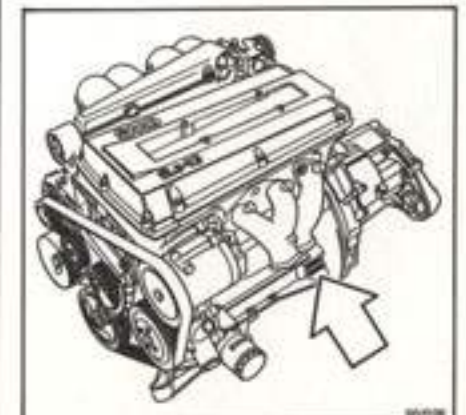

S0/026

Y	S	3	C	C	5	5	R	5	S	1	0	0	1	1	1	1
1	2	3	4	5	6	7	8	9	10	11	12					

SG1310

1 - Geographical area	Y = Northern Europe
2 - Country	S = Sweden
3 - Motor manufacturer	3 = Saab Automobile AB
4 - Product line	C = 9000
5 - Model series	C = CD/CS with driver's airbag D = CD/CS with driver's and passenger's airbag E = CDE/CSE with driver's airbag F = CDE/CSE with driver's and passenger's airbag G = Aero with driver's airbag

6 - Body style

4 = 4-door (CD)
6 = 5-door (CS)

7 - Gearbox

5 = Man. 5-speed gearbox
8 = 4-speed autom. transm.

8 - Engine variant

B = 2.3 i
J = 2.0 i
M = 2.3 T
N = 2.0 T
P = 2.0 T, low boost pressure
R = 2.3 T, high power
U = 2.3 T, low boost pressure
W = 3.0 V6

9 - Check digit

0-9 or X

10 - Model year

S = 1995

11 - Production locality

1 = Trollhättan

12 - Serial number

000001-999999

Child restraint anchorages five-door models (Australia only)

To attach the restraints:

- 1 Remove the three covering plugs from the rectangular holes in the luggage compartment sill.
- 2 Fasten the anchor bolts with their shackles in the holes. Spacers are not required.

Bolt dimension: 5/16" 18 UNC, length 30 mm.

Child restraint anchorages, four-door models (Australia only)

- 1 Disengage the head restraint by pulling the catch upwards. Remove the head restraints by pulling upwards (outboard seating positions only).
- 2 Remove the covering plug(s) from the hole(s) in the parcel shelf.
- 3 Fasten the anchor bolt in the hole using the specially designed spacer.

Bolt dimension: UNC 5/16, length 30 mm.
Spacer dimension: 20 mm \varnothing
(hole 12 mm \varnothing), thickness 10 mm.

WARNING:

Child restraint anchorages are designed to withstand only those loads imposed by correctly fitted child restraint. Under no circumstances are they to be used for adult seat belts, harnesses or for attaching other items or equipment to the vehicle.

Child restraint anchorages

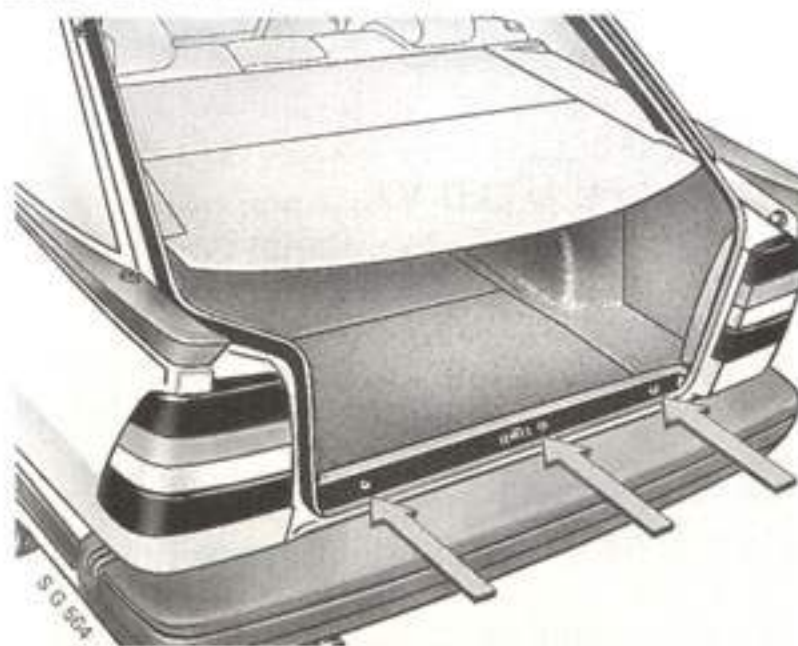

Child restraint anchorages in parcel shelf

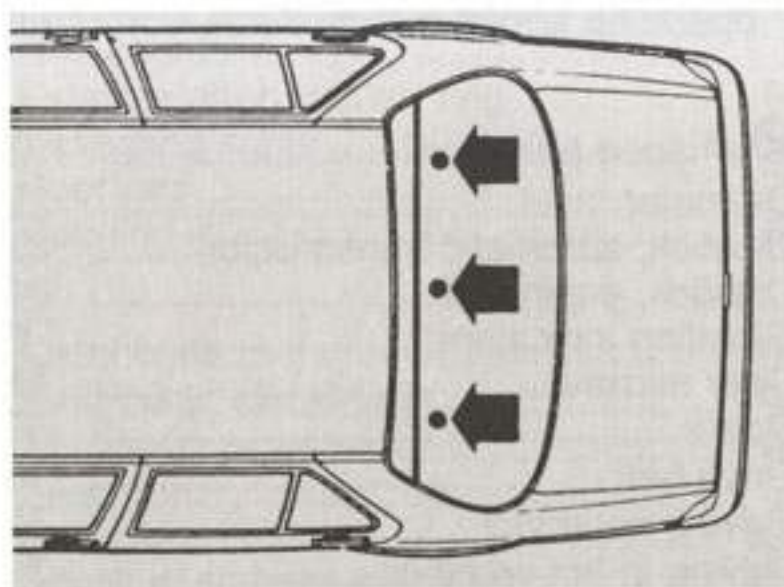

Index

- A**BS..... 69
 Air conditioning..... 20, 25
 Air conditioning, fault diagnosis 100
 Air recirculation 20, 25
 Air supply control 19, 25
 Alternator 88
 Alternator belt..... 110
 Alternator, drive belt tension 88
 Anti-corrosion treatment..... 103
 Anti-freeze, mixture 83
 Anti-skid devices 73
 Anti-theft alarm..... 58
 Ashtrays 49
 Audio System 27
 Automatic climate control (ACC)..... 21
 Automatic transmission, driving 66
- B**attery 86
 Battery acid 86
 Body maintenance 102
 Bonnet 57
 Boost starting 87
 Brake fluid, grade..... 85
 Brake fluid grade 113
 Brake fluid reservoir 85
 Brake fluid, topping-up 85
 Braking 69
- C**aravan, towing a..... 74
 Cargo space 53
 Carpets, cleaning 102
 Cassette player 31
 Catalytic converter 64
 CD player 33
 Central locking 52
 Changing bulbs 90
 Changing the coolant 84
 Changing the wheels 98
 Changing wiper blades 89
 Chassis number 115
 Child safety 45
 Child safety locks 52
 Clock 9
 Colour code 115
 Compact spare wheel 99,113,114
 Computer..... 10
 Coolant temperature gauge 9
 Coolant, volume 108
 Cooling system, coolant change 84
 Cooling system, description 83
 Counterbalance shafts 80
 Cruise control, instructions..... 68
 Cruise control system,
 operating principle..... 68
- D**amaged paintwork..... 103
 Defroster..... 25
 Dipstick, automatic transmission..... 83
 Dipstick, engine oil 81
 Direction indicators..... 6
 Door mirrors 46
 Doors 52
 Drive belt 110
 Driving economy 72
 Driving in hot weather 74
 Driving in winter weather 73
 Driving with a roof-rack fitted 76
 Driving with an open
 luggage compartment door..... 76
 Driving with the compact
 spare wheel fitted..... 75
- E**conomical motoring 72
 Electric windows..... 47
 Engine compartment, cleaning 102
 Engine, data 108
 Engine, description..... 80
 Engine number 115
 Engine oil 81
 Engine oil capacity 108
 Engine oil, changing of 81
 Expansion tank, coolant..... 83
- F**an belt 110
 Fan, heating and ventilation..... 19
 Flat spots..... 100
 Footbrake 113
 Free warranty service 104
 Fresh air vents 23
 Front seats 38
 Front wheel alignment..... 114
 Frozen locks 73
 Fuel 65
 Fuel gauge 6
 Fuses..... 96,110,111
- G**ear changing 66
 Gear lever 66
 Gearbox..... 112
 Gearbox number 115
 Gearbox oil..... 83,112
 Gear-change speeds..... 66

Glove compartment.....	57	Oil pressure	8	Spare wheel	99,113,114
H eadlight, alignment of.....	90	Oils	112	Sparkplugs	110
Headlight dip and flasher switch.....	15	Oxyhydrogen	86	Speedometer and odometer	9
Headlight wipers.....	89	P aintwork	103	Start assistance.....	87
Headlights, changing of bulbs.....	90	Parcel shelf	53	Starting	62
Heating and ventilation	19, 24	Parking light	15	Steering	86
Height adjustment, driving seat	38	Pictogram	8	Steering mechanism	86,113
I gnition key.....	62	Polishing.....	102	Studded tyres	73
Ignition switch and steering lock.....	62	Power steering	86	Sun sensor	23
Indicator and warning lights	6	Pressure gauge.....	9	Sunroof.....	48
Instrument illumination	16	R adiator expansion tank.....	83	Suspension.....	113
Instruments.....	9	Radio	27	Switches	15
Interior light bulbs.....	94, 95	RDS radio.....	27	T echnical data.....	105
Interior lighting.....	18	Rear fog light.....	16	Temperature control.....	19, 23
J ack.....	98	Rear lights	92	Temperature gauge, coolant.....	9
Jacking points	98	Rear seats.....	53	Towing a trailer or caravan	74
L ight bulbs	95	Rear window heating	20, 25	Towing the car	76
Locks	52	Rear-view mirrors.....	46	Towrope attachment eyes.....	77
Luggage compartment	53	Resetting the display EDU.....	11	Trailer, towing a	74
Luggage compartment door.....	53	Rev counter.....	9	Trailer weight.....	74
M aintenance programme.....	104	Reverse gear release ring	66	Transmission oil	112
Mirrors	46	Reversing lights.....	16, 92	Trip computer	10
Mobile telephone.....	35	Roof rack.....	76	Trolley jacks, use of.....	98
Motoring abroad	104	Running in	65	Turbo pressure gauge.....	9
O dometer.....	9	S eat belts.....	40	Turning circle.....	106
Oil dipstick.....	81	Seat belts, cleaning of	40	Tyre pressures	97
		Seat-belt pretensioner.....	41	Tyres	97,113
		Seats	38	U pholstery.....	101
		Servicing.....	104	Using the ACC:.....	26
		Shock absorbers (dampers).....	113	V alve clearance	63
		Snow chains.....	73	Ventilation and heating controls... ..	19, 24
		Snow tyres	73,114	Ventilator fan	19, 24

120 Index

Volume, coolant	108
W arning and indicator lights.....	6
Warning triangle	17
Washer fluid	89
Washer jets	89
Washers	89
Washing the car	102
Waxing	102
Wear indicators (tyres).....	98
Wheels and tyres	97,113
Wheels and tyres, changing	98
Windscreen washer and wiper switch	17
Windscreen washers.....	17, 89
Windscreen wipers.....	17, 89
Winter driving	73
Winter tyres	114
Wipers	89

Fuel

9000 CD/CS: recommended 95 RON, min 91 RON

9000 Aero: recommended 98 RON, min 91 RON

Insert the filler nozzle past the flange in the filler pipe and let the first position mark (ring, cast "pads" or first coil of the spring) rest against the flange. Do not raise the filler nozzle while the tank is being filled.

Fuel tank capacity: 66 l (14 imp. gal).

N.B. Do not overfill. The level must not come up into the filler pipe as expansion room is needed for the fuel.

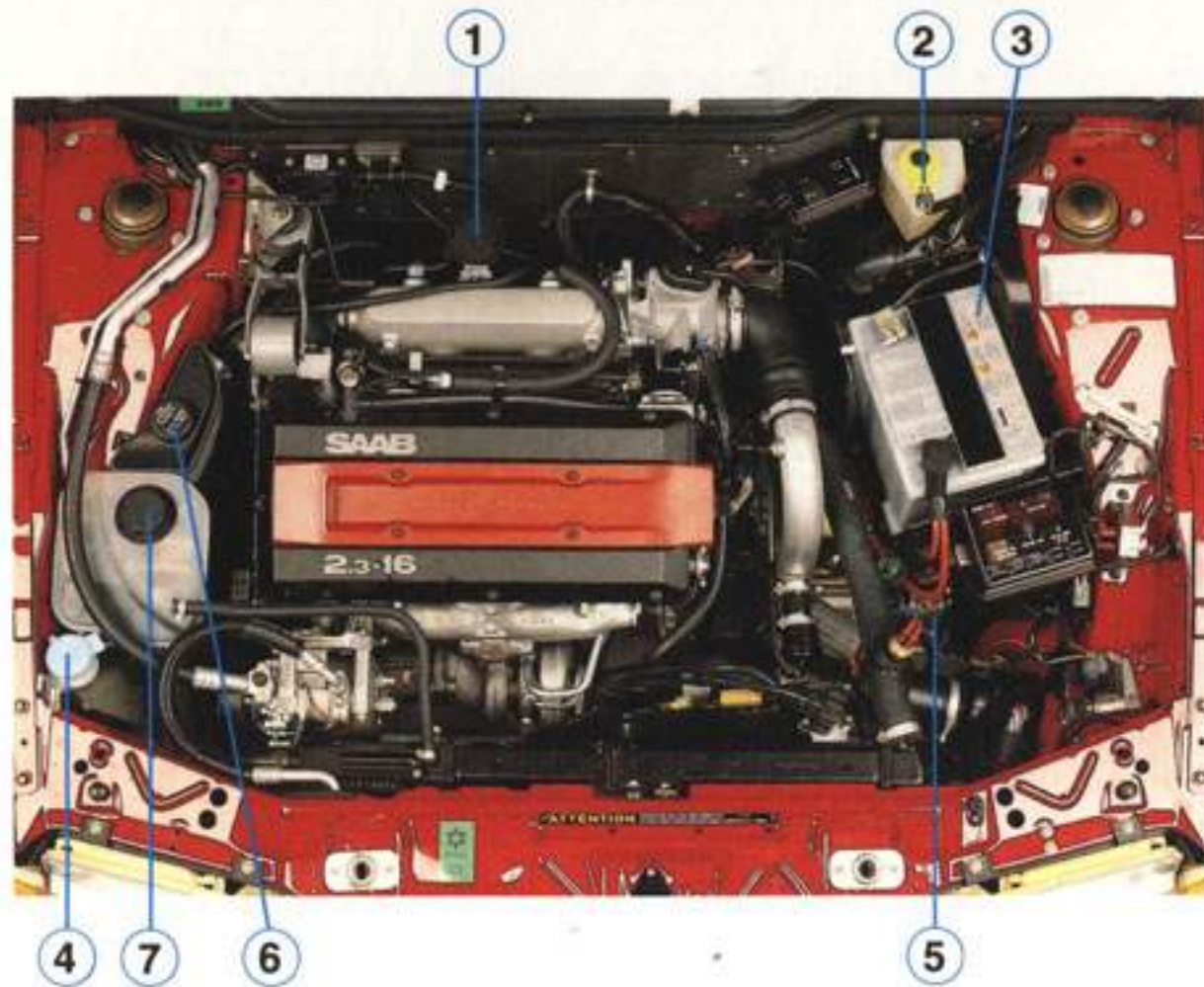

1 Engine oil

Grade of oil: Saab Turbo Engine Oil or an oil which meets the requirements of API Service SG and CCMC G4 or G5.

Viscosity: 10W/30, 10W/40, 5W/30 or 5W/40.

2 Brake/clutch fluid

Brake fluid to DOT 4.

3 Battery

4 Washer fluid

5 Automatic transmission oil

Dexron 2 ATF.

6 Power Steering

Oil type Saab Power Steering Fluid 1890

7 Coolant

Do not allow the coolant level to fall below the MIN mark on the expansion tank. Top up, as necessary, with a mixture of equal parts Saab anti-freeze and water.

Take care when opening the bonnet if the engine is boiling. Never open the filler cap on the expansion tank while the engine is hot. Allow the engine to cool down before removing the cap.

The cooling system is pressurized. Always open the filler cap on the expansion tank carefully to release the pressure before removing the cap completely.

VEHICLE EMISSION CONTROL INFORMATION

AU 1995

MODEL: SAAB 900 I
ENGINE SIZE: 2301 CM³
ENGINE FAMILY: G1-4-BL, NATURALLY ASPIRATED

EXHAUST EMISSION CONTROL SYSTEM: ELECTRONIC FUEL INJECTION, CLOSED LOOP SYSTEM WITH THREE WAY CATALYST

NO ADJUSTMENTS NEEDED
SPARK PLUG GAP: 1.2 $\begin{smallmatrix} +0.1 \\ -0.2 \end{smallmatrix}$ MM

THIS VEHICLE CONFORMS TO THE AUSTRALIAN EXHAUST EMISSION CONTROL REGULATIONS ADR 37 APPLICABLE TO 1995 NEW MOTOR VEHICLES.

FUEL SPEC.
91 RON

Manufactured by Saab Automobile AB, Trollhättan, Sweden

45 25 994

VEHICLE EMISSION CONTROL INFORMATION

AU 1995

MODEL: SAAB 900 turbo
ENGINE SIZE: 2300 CM³
ENGINE FAMILY: G2-TURBO-BL, TURBOCHARGED

EXHAUST EMISSION CONTROL SYSTEM: ELECTRONIC FUEL INJECTION, CLOSED LOOP SYSTEM WITH THREE WAY CATALYST

NO ADJUSTMENTS NEEDED
SPARK PLUG GAP: 1.3 $\begin{smallmatrix} +0.1 \\ -0.2 \end{smallmatrix}$ MM

THIS VEHICLE CONFORMS TO THE AUSTRALIAN EXHAUST EMISSION CONTROL REGULATIONS ADR 37 APPLICABLE TO 1995 NEW MOTOR VEHICLES.

FUEL SPEC.
91 RON

Manufactured by Saab Automobile AB, Trollhättan, Sweden

45 26 000

VEHICLE EMISSION CONTROL INFORMATION

AU 1995

MODEL: SAAB 900 turbo
ENGINE SIZE: 2300 CM³
ENGINE FAMILY: G1-TURBO-BL, TURBOCHARGED

EXHAUST EMISSION CONTROL SYSTEM: ELECTRONIC FUEL INJECTION, CLOSED LOOP SYSTEM WITH THREE WAY CATALYST

NO ADJUSTMENTS NEEDED
SPARK PLUG GAP: 1.3 $\begin{smallmatrix} +0.1 \\ -0.2 \end{smallmatrix}$ MM

THIS VEHICLE CONFORMS TO THE AUSTRALIAN EXHAUST EMISSION CONTROL REGULATIONS ADR 37 APPLICABLE TO 1995 NEW MOTOR VEHICLES.

FUEL SPEC.
95 RON

Manufactured by Saab Automobile AB, Trollhättan, Sweden

45 26 018

VEHICLE EMISSION CONTROL INFORMATION

AU 1995

MODEL: SAAB 900 V6
ENGINE SIZE: 2962 CM³
ENGINE FAMILY: 301-V6-BL, NATURALLY ASPIRATED

EXHAUST EMISSION CONTROL SYSTEM: ELECTRONIC FUEL INJECTION, CLOSED LOOP SYSTEM WITH THREE WAY CATALYST

NO ADJUSTMENTS NEEDED

THIS VEHICLE CONFORMS TO THE AUSTRALIAN EXHAUST EMISSION CONTROL REGULATIONS ADR 37 APPLICABLE TO 1995 NEW MOTOR VEHICLES.

FUEL SPEC.
91 RON

Manufactured by Saab Automobile AB, Trollhättan, Sweden

45 26 026



SAAB

Saab Automobile AB
Trollhättan, Sweden

saab-club.com

Ordering No. 40 77 42
Copyright © Saab Automobile AB, Printed in Sweden

